

קומה 24 - מוקדים

ITOC, SOC, ביטחון

@HANDALA HACK

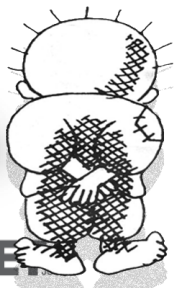
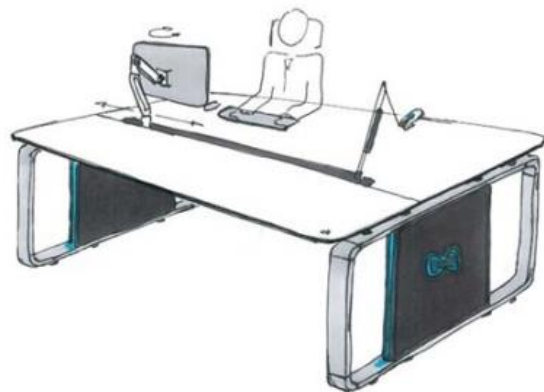

פועלים
CENTER
שמים אתכם במרכז

ARROWNET



@HANDALA HACK



תכנית קומה 24

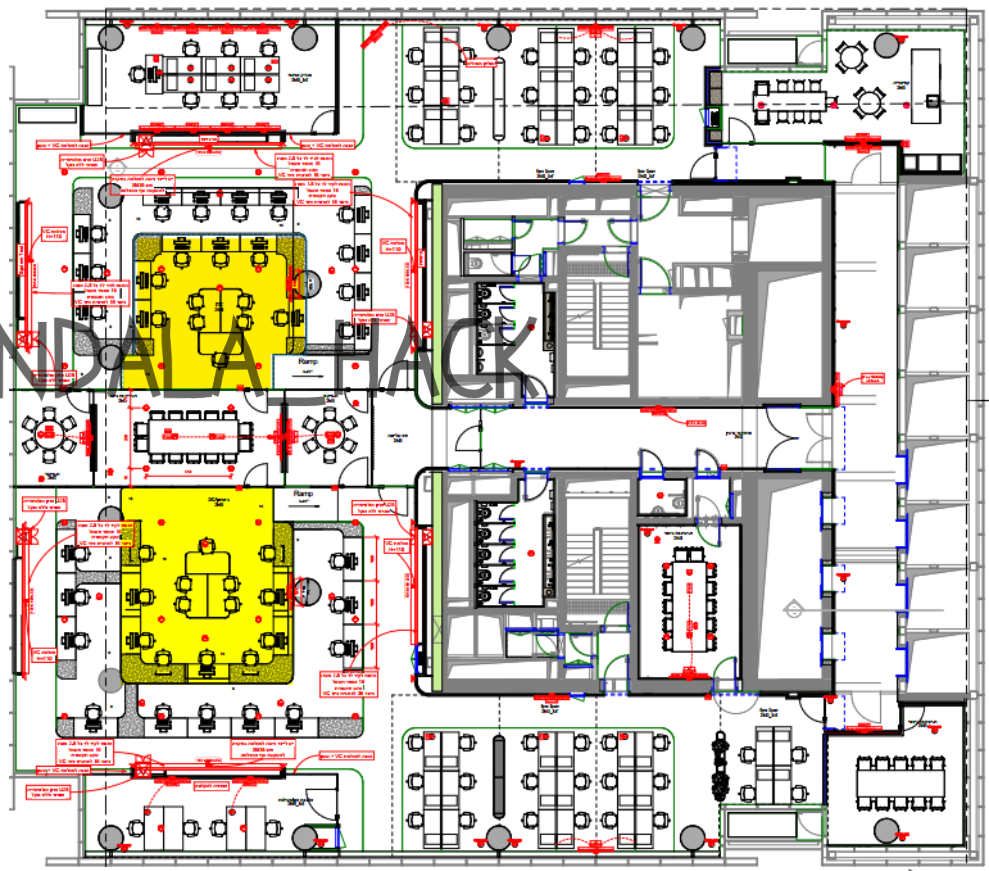

@HANDALA HACK

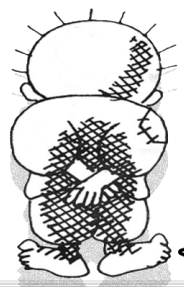

@HANDALA HACK

רצפה צפה

הגבהת אזור מנהלים ואחמ"ש כולל השורה השנייה ע"מ לאפשר זוויות צפיה טובה לקיר התצוגה במטרה להפחית את ההסתרה.

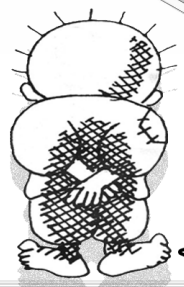
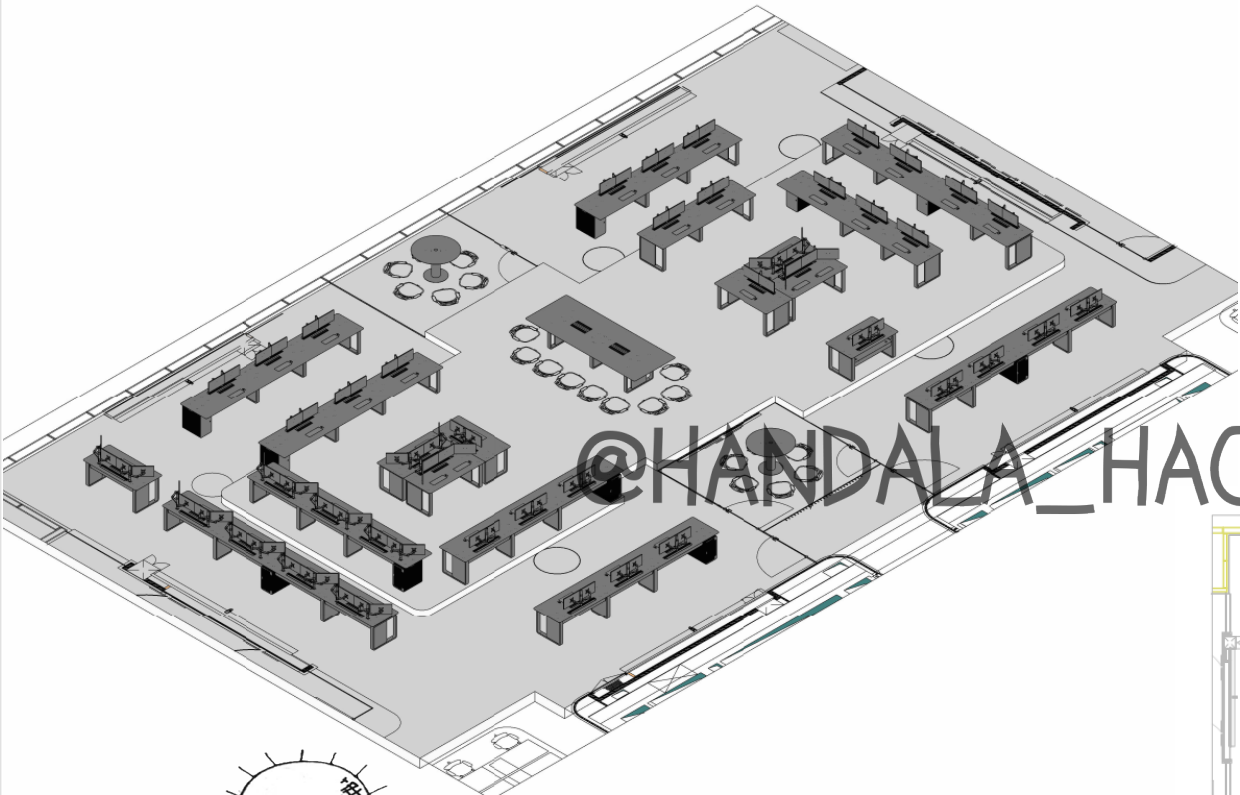

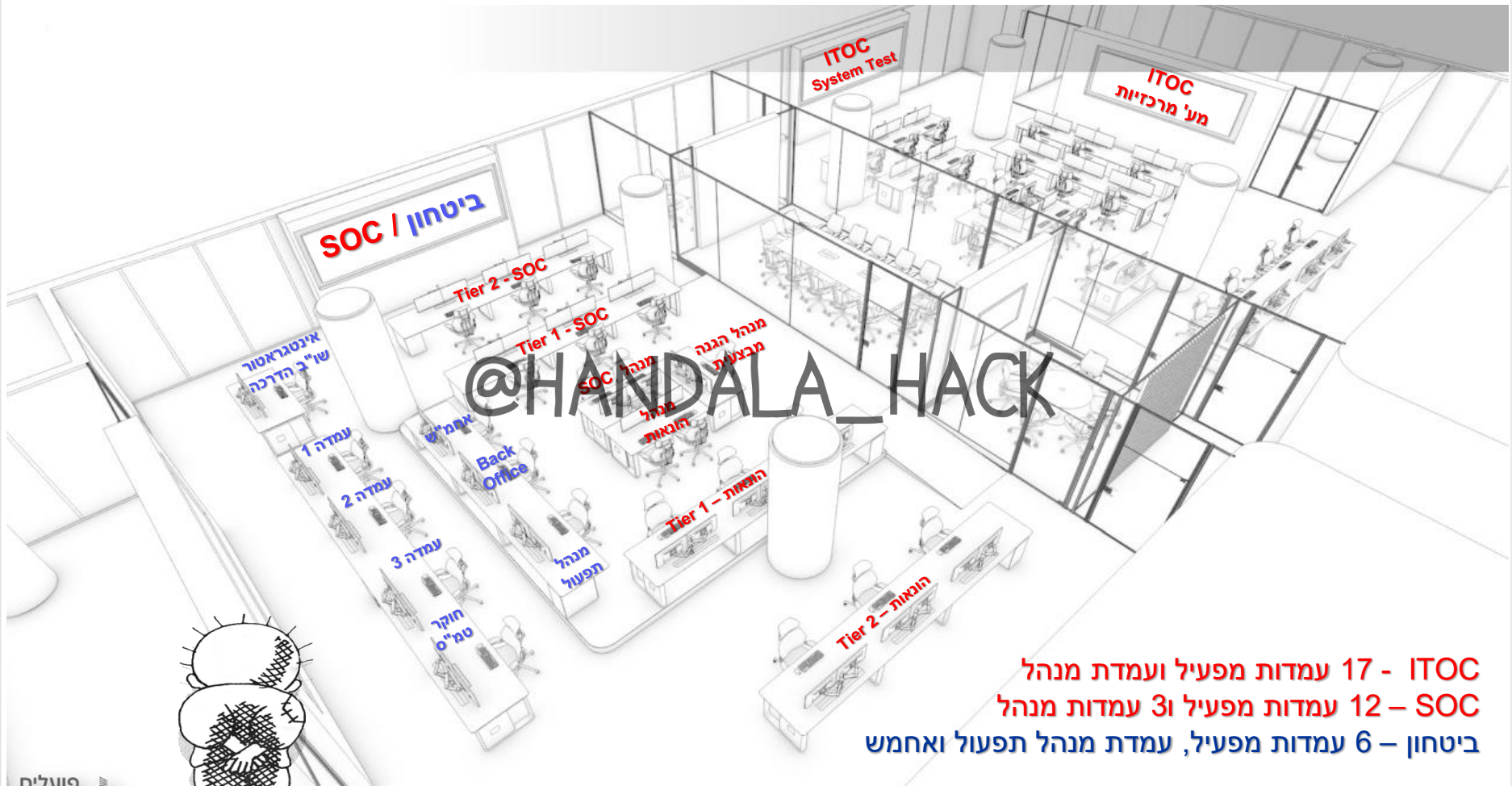

ITOC - 17 עמדות מפעיל ועמדת מנהל
 SOC - 12 עמדות מפעיל ו3 עמדות מנהל
 ביטחון - 6 עמדות מפעיל, עמדת מנהל תפעול ואחמש

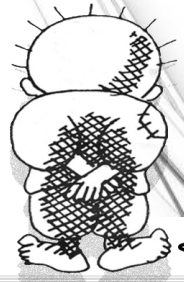

מכלול המערכות בחדרי בקרה ושליטה

1. סביבה: אוורור, תאורה עם הפחתת סנזור, בקרת טמפרטורה והפחתת רעש.
חשמל חכם: חלוקה לאזורי תאורה ושליטה על מיזוג
ריהוט ארגונומי ונגישות: כיסאות נוחים שולחנות כתיבה ועבודה

2. טכנולוגיה: תחנות עבודה: תחנות הפיקוד עם מספר מסכים או צגים להצגת מידע, לרבות מקלדות.
פנלי שליטה: מערך לחצנים, מתגים וכפתורים המאפשרים למפעילים לקיים אינטראקציה עם המערכות.
מערכות תצוגה: קירות וידאו, מסכים גדולים או מוניטורים המספקים ייצוג חזותי של נתונים.
ציוד תקשורת: מערכות תקשורת, כגון טלפונים, אינטרקום ואוזניות
מערכות אבטחה: בקרת כניסה, מעלמות מעקב ואמצעי אבטחה נוספים
מערכת ועידת וידאו: תקשורת עם בעלי עניין או מומחים חיצוניים מרחוק.
מערכות הקלטה והשמעה: סקירת אירועים קודמים למטרות ניתוח הדרכה ותחקור.
תשתית רשת: תשתית רשת איתנה לחיבור מערכות והתקנים שונים בתוך חדר הבקרה.

3. מערכות גיבוי: חשמל: אל-פסק (UPS) וגנרטורים, הבטחת פעולה רציפה במקרה של הפסקות חשמל.
תקשורת: רשת תקשורת מגובה, סייבר, לרבות אפשרות שימוש בחדרי תקשורת ממפלסים שונים, גיבוי מול אתר חיצוני (רותם).

מערכות תצוגה: חיבורים ישירים עוקפי מערכות טכנולוגיות.
מערכות ביטחון: בהתאם למדיניות מנהל המערך.

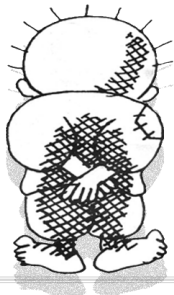

@HANDALA_HACK

תקנים בנושא ארגונומיה ונגישות

ISO 11064 - קובע עקרונות ארגונומיים לפריסה של חדרי בקרה. כולל דרישות, המלצות והנחיות לגבי פריסת חדרי בקרה, סידורי תחנות עבודה, שימוש בתצוגות חזותיות מחוץ לתחנת העבודה ותחזוקת חדר בקרה.

EN ISO 9241-5 (UNE-EN-ISO 9241-5) - דרישות ארגונומיות לתחנות עבודה עם מסך / תכנון פריסת תחנות עבודה ודרישות יציבה (חלק 5)

@HANDALA HACK

EN 527-1:2011 - תקן אירופי מפרט מידות של שולחנות עבודה ושולחנות עבודה עבור משימות משרדיות שיש לבצע בישיבה, או בעמידה. אינו כולל מידות עבור יחידת אחסון או מידות עבור שולחנות אחרים באזור המשרד או דלפקי הקבלה.

ת"י 6385 - עקרונות ארגונומיים לתכנון מערכות עבודה, מאוקטובר 2013

ת"י 9241 - דרישות ארגונומיות לעבודות משרדיות עם מסופי צג הנחיות לדרישות משימה, מאוקטובר 2013

**המלצות בנושא תכנון חדרי בקרה כולל ריהוט ייעודי:

<https://www.iso.org/fr/standard/54419.html>

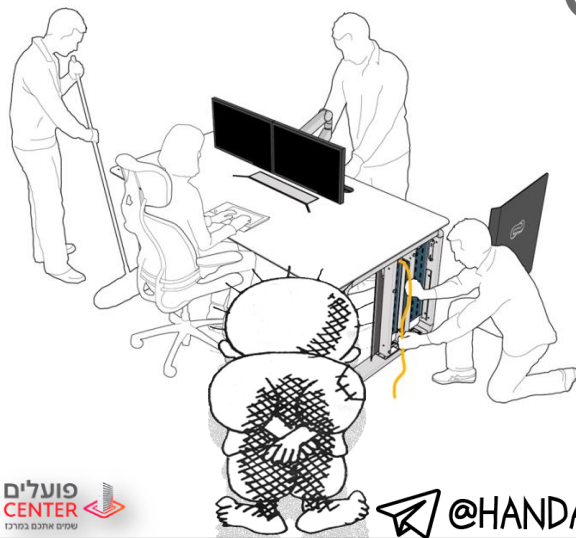
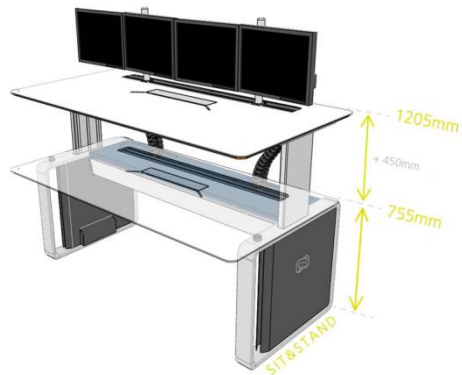

מפרט כללי - ריהוט ייעודי

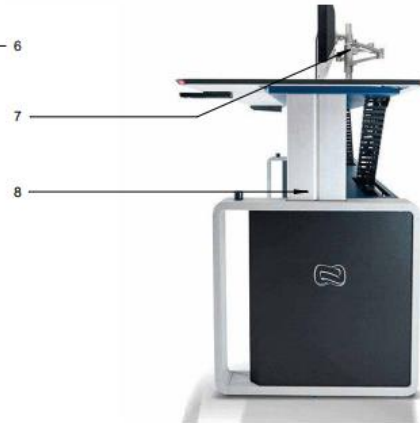
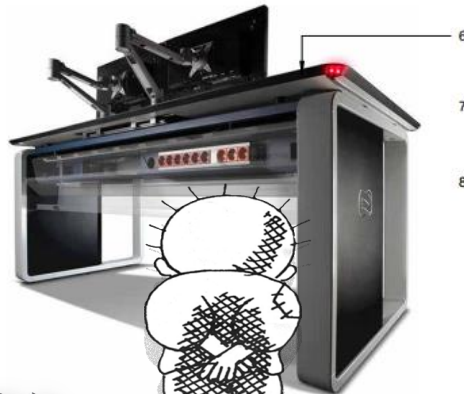

ADVANTIS NG is certified according to ergonomics regulations UNE-EN 527-2011, in its 3 sections and meets the ergonomics and design criteria specified in the ISO 11064 and NTP 602 regulations.

Also ADVANTIS NG has compliance certificate GREENGUARD UL 2818-2013 Standard for Chemical Emissions for Building Materials, Finishes and Furnishings certificate of the line furniture.

- 1. Work surface** manufactured and machined in high pressure compact phenolic resin board, bilaminated with a thickness of 18 mm, whose surface is anti-reflective and anti-scratch. Beveled and rounded work surface at all points of contact, eliminating any type of aggressive edge or angle.
- 2. Personal Dock** with a personal area where electrical /multimedia connections are located. It is integrated in the surface coplanar with the worktop.
- 3. Server Cabinet.** (Optional equipment) Structure of modular aluminum profiles with a wall thickness of not less than 2.7mm and a width of 300mm, glass front door and steel rear door. It builds a 19" rackable space for devices.
- 4. Spine Beam.** Central steel structure, with a minimum thickness of 3 mm, in the shape of a "T" with external measures 175x370mm in section, with lengths available every 100 mm from 600 mm to 2,900 mm. Provides adequate space for cable management and housing of electronic hardware and equipment.
- 5. Nexus Gate sides.** facilitate the management of the system using magnetic access doors that leave access to the interior technical area completely free. It includes an integrated lighting system that illuminates the central space between doors.
- 6. Wirail system.** Ergonomic arm management system using extruded aluminum profile with double rail, dimensions 43x60 mm, which is installed fully integrated and coplanar with the work surface.
- 7. Arm Support Solution** for screens in Wirail.
- 8. Sit & Stand system** (Optional equipment) composed by:
 - 2 x Lifting electric Motors
 - 2 x Cable Management Chains
 - 1 x User Interface

תצוגה מרכזית – שישה "קנבסים"

625 ס"מ

138
ס"מ

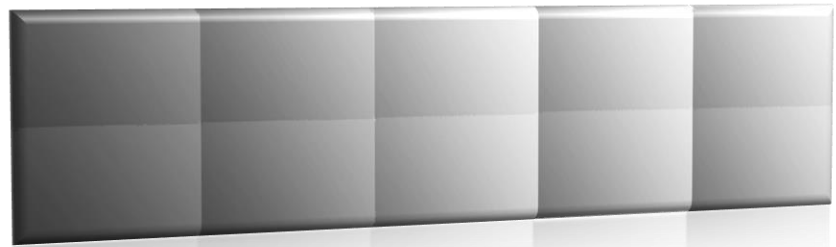

625cm

605cm

Video Wall 5x2, 55"
605cm x 138cm

138cm

158cm

270cm

112cm

Lockers
615 cm x 112 cm

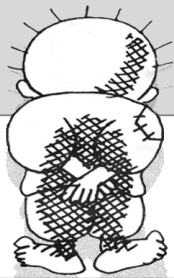

@HANDALA_HACK

1. מסכים בגודל 55", קיר מסכים בתצורה של 5X2
2. 24/7 Operation Hours
3. Narrow Bezel 0.44mm
4. HAZE ניתן להורדה ל28% לשיפור קריאת טקסט
5. 700 nits FHD
6. sensor calibration
7. מתקני תליה POPUP – תחזוקה חזיתית



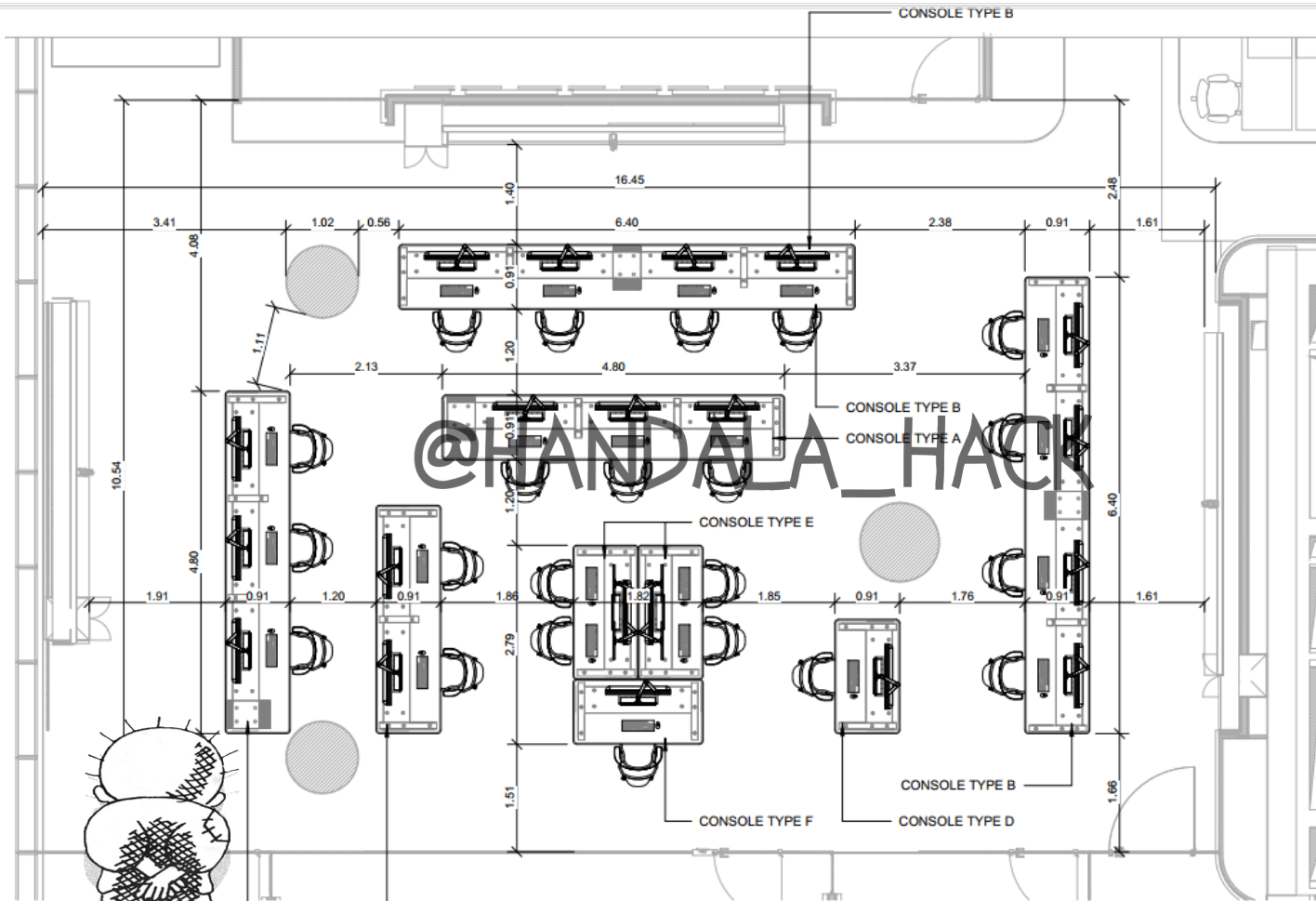

@HANDALA HACK

SOC ביטחון

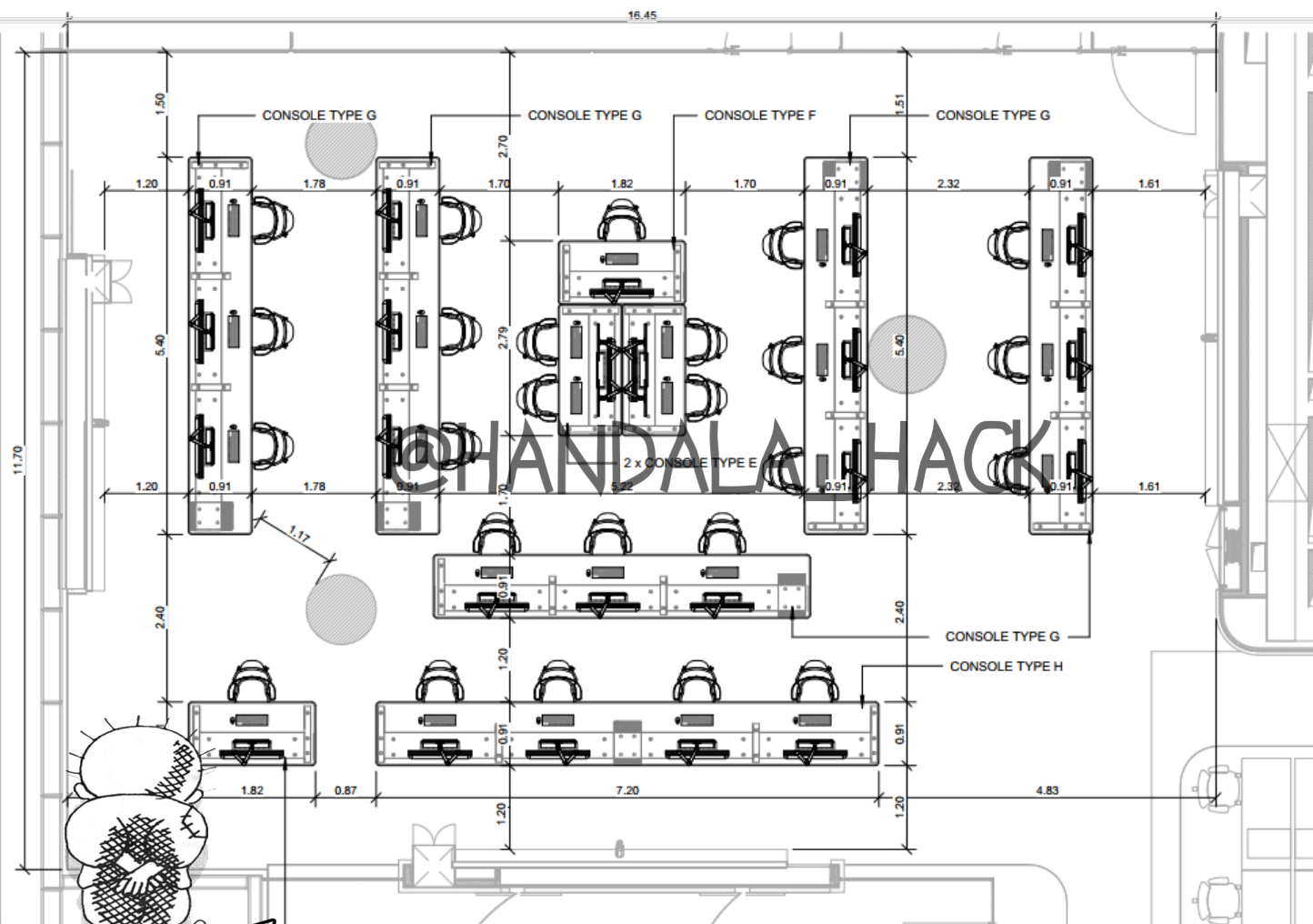

ITOC

@HANDALA_HACK

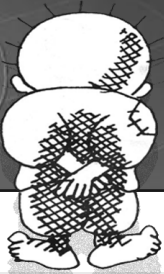

פועלים
CENTER
שמים אתכם במרכז

@HANDALA_HACK

imagen 7

ARROWNET
JUST IT

ITOC

@HANDALA_HACK

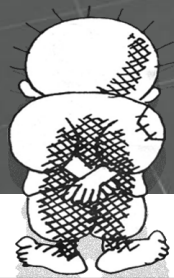

SOC / ביטחון

@HANDALA HACK

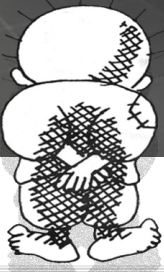

@HANDALA HACK

SOC / ביטחון



שימוש בטכנולוגיות

1. הרחקת מחשבים/מקורות מהשולחן (אחסון בחדר השרתים, אזור בטוח, ממוזג, ניתן לבטל פליטת חום ורעש).
2. גיבויים, BCP
3. Secured IP KVM
4. Keyboard Follow Mouse
5. Video Conference
6. הקלטה ואחסון מידע
7. שמע



@HANDALA_HACK

ריכוז AV

2 x 48P Stack switches



CISCO SWITCH NETWORK

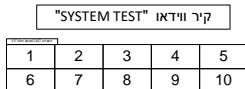
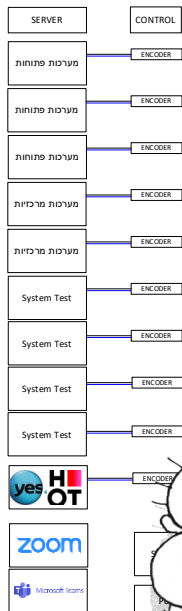

מצלמות וידאו קפיסרים

10 x PoE Decoders



מצלמות וידאו קפיסרים

10 x PoE Decoders

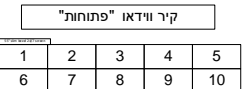

מצלמות וידאו קפיסרים

10 x PoE Decoders



שם הליקון

בנק הפועלים



8 x PoE Decoders



מבדק ושיגור

10" TP

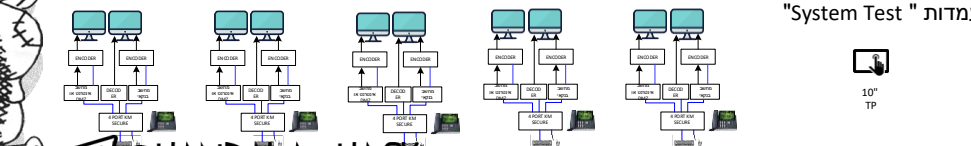
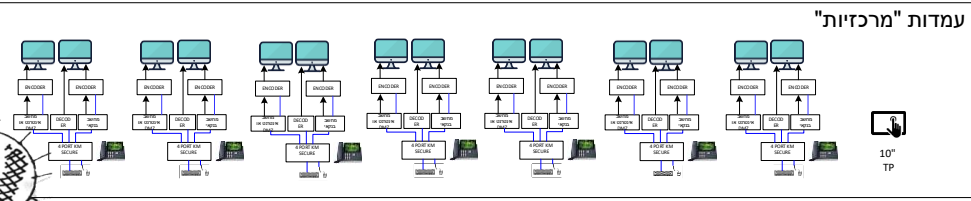
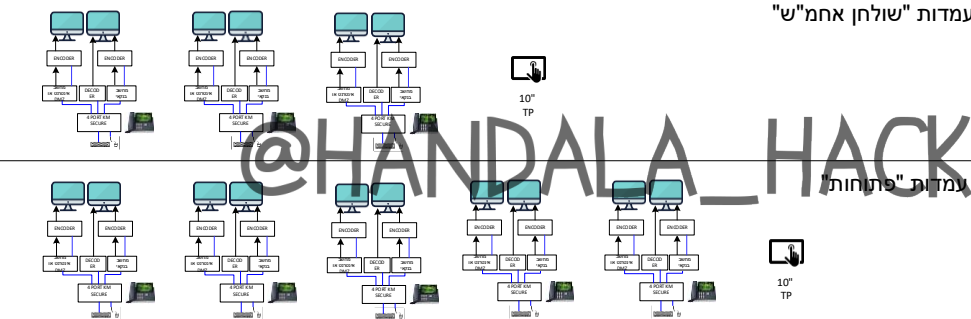

Scale No Scale

שם השריטוט

ITOC

שם הפרויקט

פועלים סנטר קומה 24

טכנולוגיה (ITOC) – תרשים עקרוני

טכנולוגיה - (ביטחון) - תרשים עקרוני

ריכוז AV

קיר וידאו בטחון

1	2	3	4	5
6	7	8	9	10



מולת
וידאו
קפיסום

10 x PoE
Decoders



3 מיקרופונים
תקרותיים

12 רוקטים
שקועים

שם הלוקוס

בנק הפועלים

2 x 48P Stack switches



CISCO SWITCH NETWORK

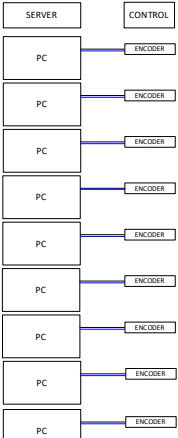

שורה אחורית

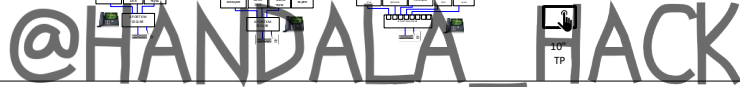

שורה קדמית

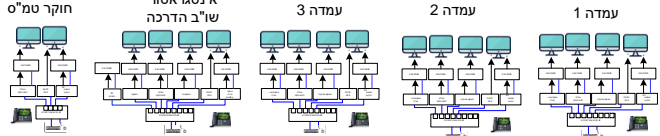

HDMI
AUDIO
USB

Scale No Scale

גיבוי : קומה 4-

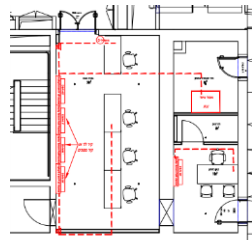
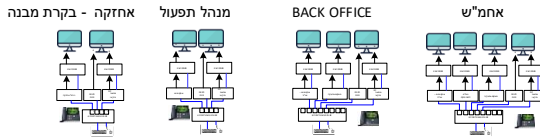

חדר ביטחון + גיבוי

בקרת מבנה BMS

שם הפרויקט
פועלים סנטר
קומה 24

קיר וידאו בטחון

1	2	3	4
5	6	7	8

מולת

8 x PoE
Decoders

@HANDALA HACK

ריסוד AV



CISCO SWITCH NETWORK

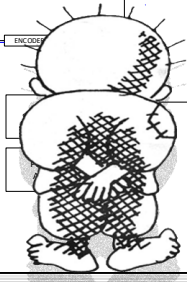
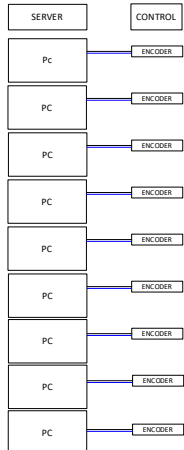

פועלים פועלים CENTER סניפים ארבעה בטרנס

@HANDALA HACK

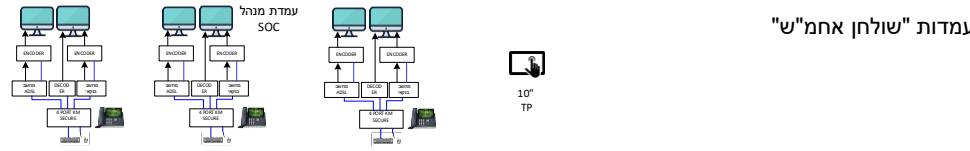
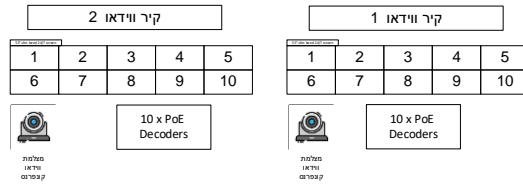

עמדות "שולחן אחמ"ש"

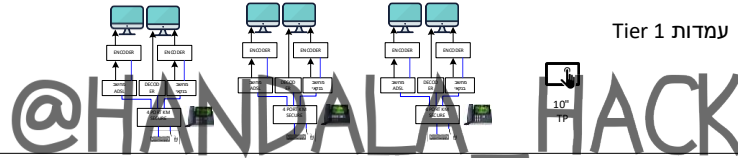

עמדות Tier 1

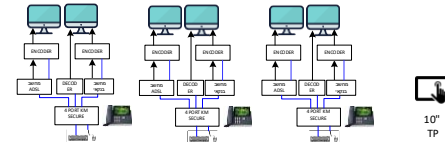

עמדות Tier 2

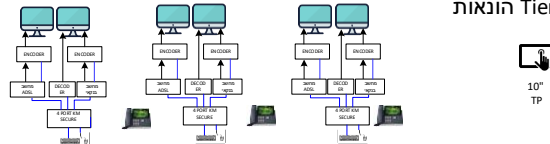

עמדות Tier 1 הונאות

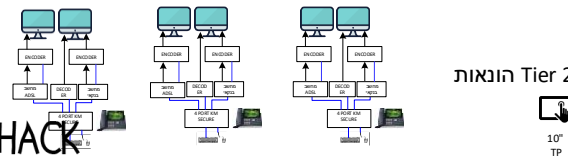

עמדות Tier 2 הונאות

שם הלקוח

בנק הפועלים

טכנולוגיה (SOC) – תרשים עקרוני



Scale No Scale

שם הפרויקט

ITOC

שם הפרויקט

פועלים סנטר קומה 24

טכנולוגיה הרחקת מחשבים:

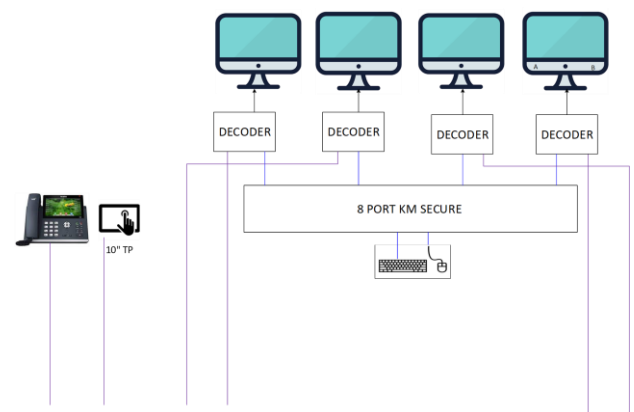

@HANDALA_HACK

טכנולוגיה ללא הרחקת מחשבים:

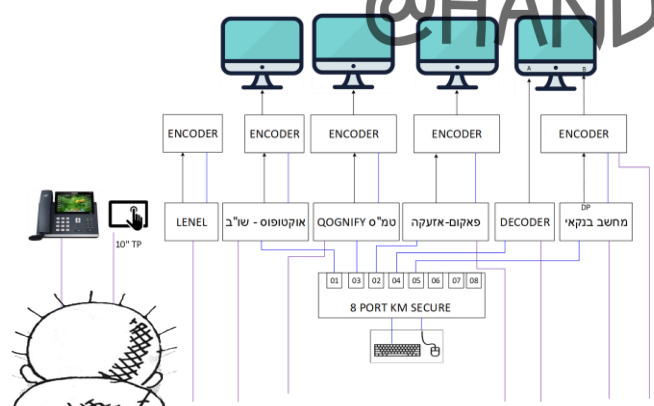

Network Per Operator + Spare

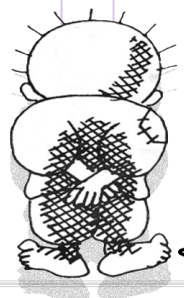

@HANDALA_HACK

סיכום והמלצות

1. שימוש בריהוט ייעודי עקב עומס תשתיות ומערכות טכנולוגיות
2. הנדסת אנוש ונגישות
3. הרחקת מחשבים
4. שרידות וגיבויים
5. התראות חזותיות וקוליות



@HANDALA_HACK

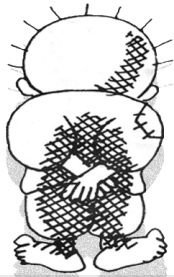

 @HANDALA_HACK

Type A



@HANDALA HACK

DIMENSIONS: LDH 4800 x 910 x 750 H mm

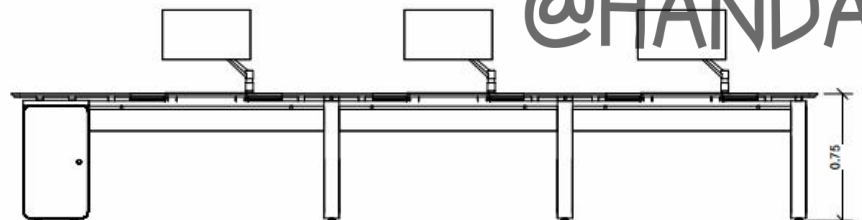

Arm Support Solution for 3 screens in Wirail, composed by:

- 3 x Ergonomic arm with 2 links, for the installation of 1 screen up to 24" or 8 kg of weight that allows a dynamic height adjustment of 370 mm, range of 460 mm.

Conexions and accesories:

- 1 x RAIL DIN and Terminal Block.
- 3 x Plugs set on the beam, with 7 power outlets and 2 RJ45.
- 1 x Plugs set on the cabinet, with 7 power outlets and 2 RJ45.
- 3 x "Personal Dock" for personal connections with 2 Power, 2 RJ45.
- 2 x Customer's backlighted logo on sides.
- LED security lighting system in corners.

Finishes:

- Work surface: 18 mm white phenolic, black core.
- Structure: standard colors.

Notes: Connections are included. Cabling and Electrification are not included. Further definition of the number and types of connections (RJ45, USB, USBc...) will be confirmed at the sign off. Get in contact to know all the different multimedia option available.

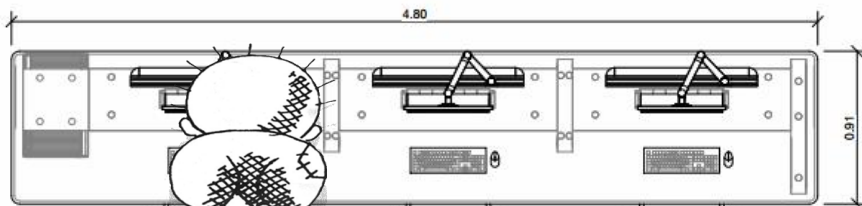

@HANDALA HACK

Type B

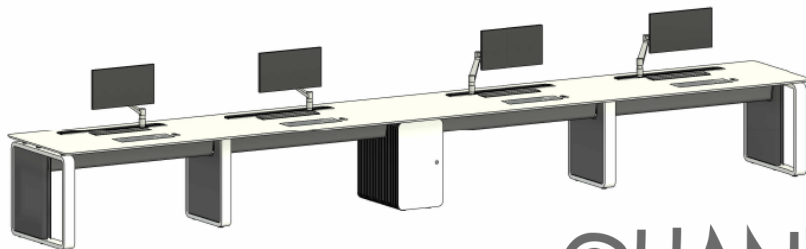

@HANDALA_HACK

DIMENSIONS: LDH 6400 x 910 x 750 H mm

Arm Support Solution for 4 screens in Wirail, composed by:
• 4 x Ergonomic arm with 2 links, for the installation of 1 screen up to 24" or 8 kg of weight that allows a dynamic height adjustment of 370 mm, range of 460 mm.

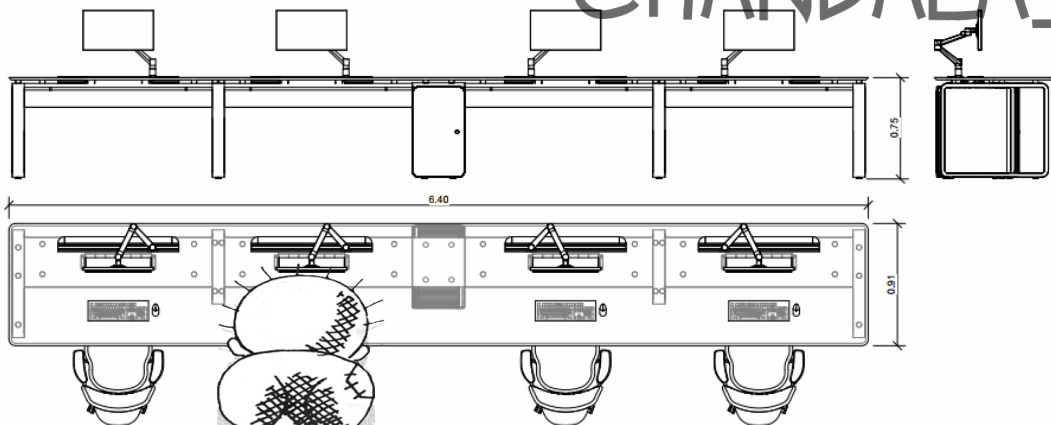

Conexions and accessories:

- 1 x RAIL DIN and Terminal Block.
- 4 x Plugs set on the beam, with 7 power outlets and 2 RJ45.
- 1 x Plugs set on the cabinet, with 7 power outlets and 2 RJ45.
- 4 x "Personal Dock" for personal connections with 2 Power, 2 RJ45.
- 2 x Customer's backlitged logo on sides.
- LED security lighting system in corners.

Finishes:

- Work surface: 18 mm white phenolic, black core.
- Structure: standard colors.

Notes: Connections are included. Cabling and Electrification are not included.
Further definition of the number and types of connections (RJ45, USB, USBc...) will be confirmed at the sign off. Get in contact to know all the different multimedia option available.

Type C

DIMENSIONS: LDH 3200 x 910 x 750 H mm

@HANDALA_HACK

Arm Support Solution for 2 screens in Wirail, composed by:

- 2 x Ergonomic arm with 2 links, for the installation of 1 screen up to 24" or 8 kg of weight that allows a dynamic height adjustment of 370 mm, range of 460 mm.

Conexions and accessories:

- 1 x RAIL DIN and Terminal Block.
- 2 x Plugs set on the beam, with 7 power outlets and 2 RJ45.
- 2 x "Personal Dock" for personal connections with 2 Power, 2 RJ45.
- 2 x Customer's backlitged logo on sides.
- LED security lighting system in corners.

Finishes:

- Work surface: 18 mm white phenolic, black core.
- Structure: standard colors.

Notes: Connections are included. Cabling and Electrification are not included.

Further definition of the number and types of connections (RJ45, USB, USBc...) will be confirmed at the sign off. Get in contact to know all the different multimedia option available.

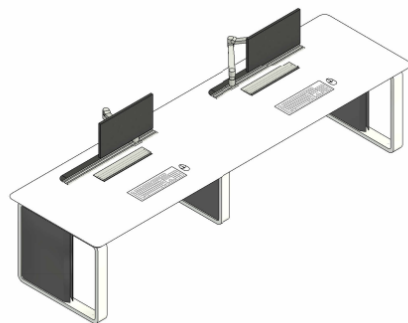
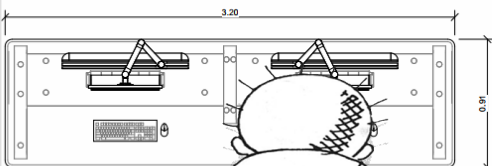
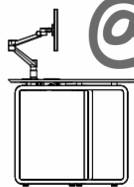
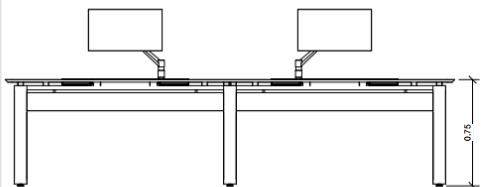

Type D

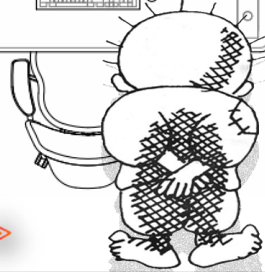
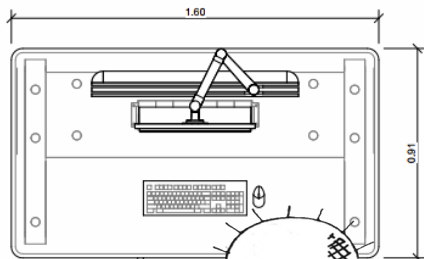
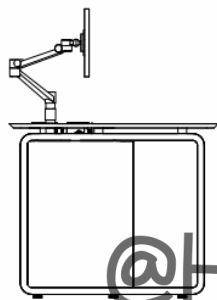
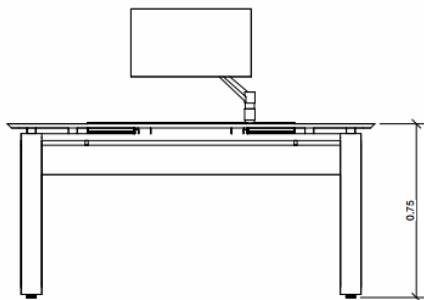

@HANDALA_HACK

DIMENSIONS: LDH 1600 x 910 x 750 H mm

Arm Support Solution for 1 screen in Wirail, composed by:

- 1 x Ergonomic arm with 2 links, for the installation of 1 screen up to 24" or 8 kg of weight that allows a dynamic height adjustment of 370 mm, range of 460 mm.

Conexions and accessories:

- 1 x RAIL DIN and Terminal Block.
- 1 x Plugs set on the beam, with 7 power outlets and 2 RJ45.
- 1 x "Personal Dock" for personal connections with 2 Power, 2 RJ45.
- 2 x Customer's backlighted logo on sides.
- LED security lighting system in corners.

Finishes:

- Work surface: 18 mm white phenolic, black core.
- Structure: standard colors.

Notes: Connections are included. Cabling and Electrification are not included.
Further definition of the number and types of connections (RJ45, USB, USBc...) will be confirmed at the sign off. Get in contact to know all the different multimedia option available.

Type E

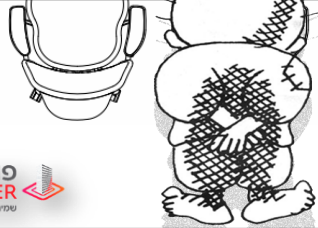
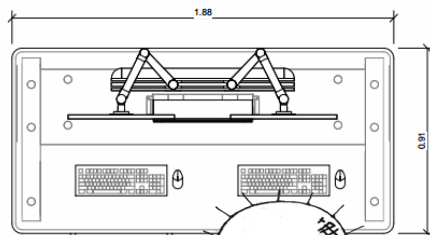
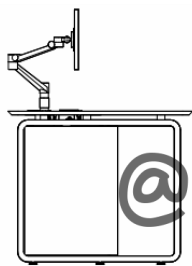
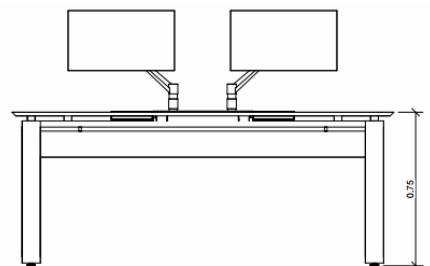

@HANDALA_HACK

DIMENSIONS: LxH 1880 x 910 x 750 H mm

Arm Support Solution for 2 screens in Wirail, composed by:

- 2 x Ergonomic arm with 2 links, for the installation of 1 screen up to 24" or 8 kg of weight that allows a dynamic height adjustment of 370 mm, range of 460 mm.

Conexions and accessories:

- 1 x RAIL DIN and Terminal Block.
- 1 x Plugs set on the beam, with 7 power outlets and 2 RJ45.
- 1 x "Personal Dock" for personal connections with 2 Power, 2 RJ45.
- 2 x Customer's backlighted logo on sides.
- LED security lighting system in corners.

Finishes:

- Work surface: 18 mm white phenolic, black core.
- Structure: standard colors.

Notes: Connections are included. Cabling and Electrification are not included.

Further definition of the number and types of connections (RJ45, USB, USBc...) will be confirmed at the sign off. Get in contact to know all the different multimedia option available.

Type F

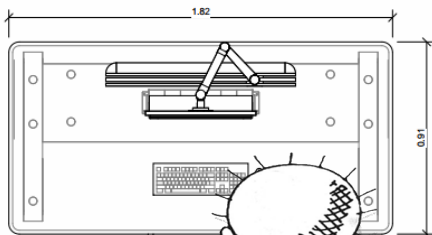
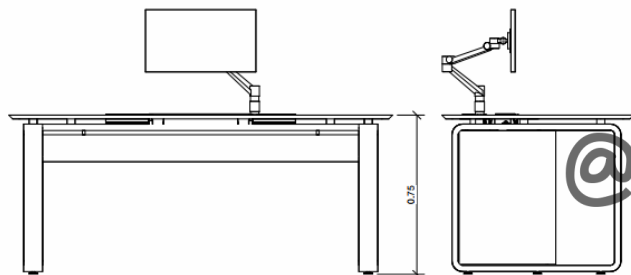

@HANDALA_HACK

DIMENSIONS: LDH 1820 x 910 x 750 H mm

Arm Support Solution for 1 screen in Wirail, composed by:

- 1 x Ergonomic arm with 2 links, for the installation of 1 screen up to 24" or 8 kg of weight that allows a dynamic height adjustment of 370 mm, range of 460 mm.

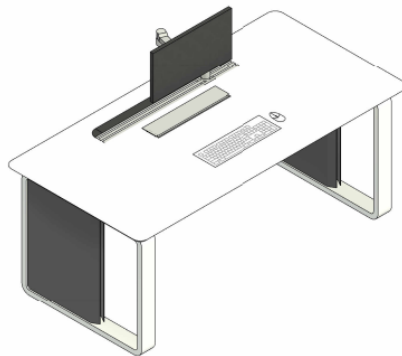

Conexions and accessories:

- 1 x RAIL DIN and Terminal Block.
- 1 x Plugs set on the beam, with 7 power outlets and 2 RJ45.
- 1 x "Personal Dock" for personal connections with 2 Power, 2 RJ45.
- 2 x Customer's backlit logo on sides.
- LED security lighting system in corners.

Finishes:

- Work surface: 18 mm white phenolic, black core.
- Structure: standard colors.

Notes: Connection_s are included. Cabling and Electrification are not included.
Further definition of the number and types of connections (RJ45, USB, USBc...) will be confirmed at the sign off. Get in contact to know all the different multimedia option available.

Type G

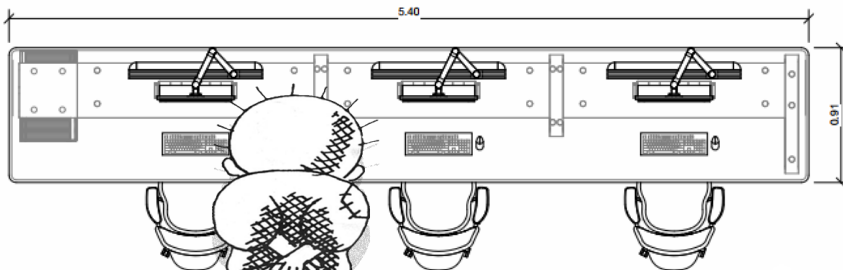
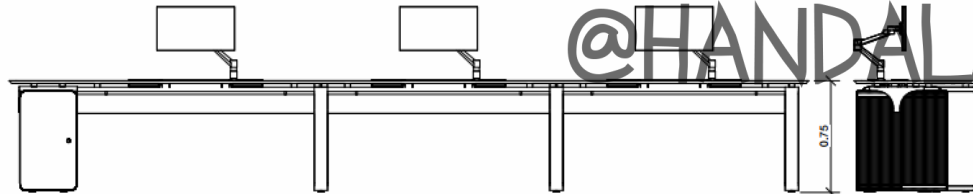

DIMENSIONS: LDH 5400 x 910 x 750 H mm

Arm Support Solution for 3 screens in Wirail, composed by:

3 x Ergonomic arm with 2 links, for the installation of 1 screen up to 24" or 8 kg of weight that allows a dynamic height adjustment of 370 mm, range of 460 mm.

Conexions and accesories:

- 1 x RAIL DIN and Terminal Block.
- 3 x Plugs set on the beam, with 7 power outlets and 2 RJ45.
- 1 x Plugs set on the cabinet, with 7 power outlets and 2 RJ45.
- 3 x "Personal Dock" for personal connections with 2 Power, 2 RJ45.
- 2 x Customer's backlighted logo on sides.
- LED security lighting system in corners.

Finishes:

- Work surface: 18 mm white phenolic, black core.
- Structure: standard colors.

Notes: Connections are included. Cabling and Electrification are not included. Further definition of the number and types of connections (RJ45, USB, USBc...) will be confirmed at the sign off. Get in contact to know all the different multimedia option available.

Type H

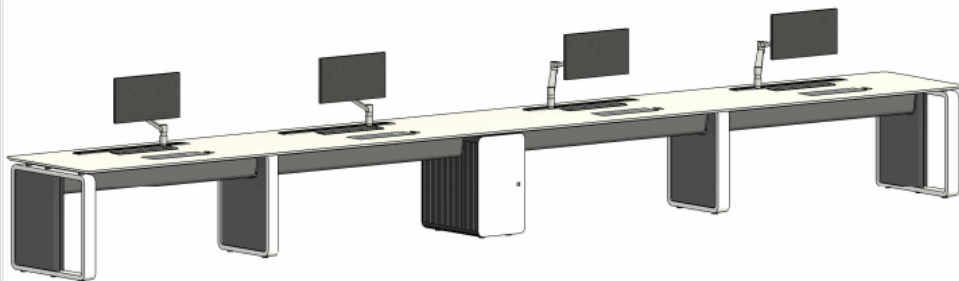

@HANDALA HACK

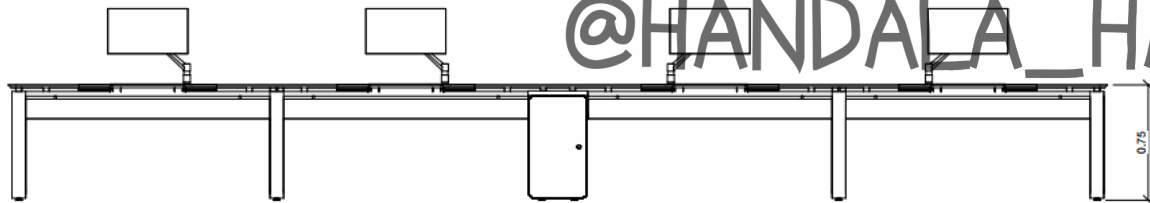

DIMENSIONS: LDH 7200 x 910 x 750 H mm

Arm Support Solution for 4 screens in Wirail, composed by:

- 4 x Ergonomic arm with 2 links, for the installation of 1 screen up to 24" or 8 kg of weight that allows a dynamic height adjustment of 370 mm, range of 460 mm.

Connections and accessories:

- 1 x RAIL DIN and Terminal Block.
- 4 x Plugs set on the beam, with 7 power outlets and 2 RJ45.
- 1 x Plugs set on the cabinet, with 7 power outlets and 2 RJ45.
- 4 x "Personal Dock" for personal connections with 2 Power, 2 RJ45.
- 2 x Customer's backlit logo on sides.
- LED security lighting system in corners.

Finishes:

- Work surface: 18 mm white phenolic, black core.
- Structure: standard colors.

Notes: Connections are included. Cabling and Electrification are not included.
Further definition of the number and types of connections (RJ45, USB, USBc...) will be confirmed at the sign off. Get in contact to know all the different multimedia option available.

