

[Skip to Main Content Area](#)



- [home](#)
- [publish](#)
- [info](#)
- [resources](#)
- [links](#)
- [participate](#)
- [newswire](#)
- [FAQ](#)
- [contact TCIMC](#)
- [donate](#)
- [sign up](#)

Upcoming events

- [Nov. 24th National Opt-Out Day! Say no to body scanners at the MSP airport!\(1 day\)](#)
- [Capitol Open Meeting w public comment on criminal intelligence data](#)

[proposal](#)(9 days)

- [TC Indymedia 2010 Resistance in Review](#)(10 days)
- ["The Forest for the Trees" Film Screening & Music by Shannon Murray](#)(17 days)



[more](#)

TCIMC 2010 Resistance in Review: [December 3](#)

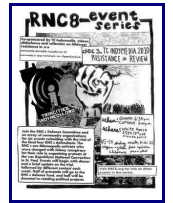

User login

[Login/Register](#)

Log in using OpenID:

[What is OpenID?](#)

Username or e-mail: *

Password: *

Log in

- [Log in using OpenID](#)
- [Cancel OpenID login](#)

- [Create new account](#)
- [Request new password](#)

Local

- [Environmental Media Picks Up On The Great American Paper Boycott!](#) Nov 23 9:32



- [MN Break the Bonds! New Video and Sign the petition for MN to divest of Israel's occupation!](#) Nov 20 13:39
- ["Sarah, Anh and Tracy have done nothing wrong. We cannot let them go to jail for us."](#) Nov 19 20:18
- [TC Indymedia Exclusive: Secret 'Trigger' & blueprint for emergency domestic military crackdown plan revealed](#) Nov 19 15:31
- [\(Video\) Grand Juries: A Tool of the Prosecution \(Legal Presentation w/ Jordan Kushner\)](#) Nov 18 23:26
- [Material Support for Terrorism: Legal Presentation featuring Jordan Kushner](#) Nov 18 23:11

- [Are there really 33 terrorist organizations in St. Paul, Minnesota?](#) Nov 17 23:11
- [Three Twin Cities Antiwar Activists Called Back to Chicago Grand Jury](#) Nov 17 20:32

[more](#)



Elsewhere

- [The Case of the Angola 3 --A review of the new film "In The Land of the Free..."](#) Nov 23 3:38



- [Picking the Colonizers' Vegetables"](#) Nov 22 15:39
- [Talon de fer](#) Nov 22 11:28
- [Iowa Anarchists Shut Down Fascists in Des Moines](#) Nov 21 10:31
- [Bill Clinton: Haiti's neocolonial overlord](#) Nov 20 22:36

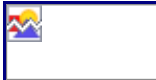

- [ESCANDALOS DE FERNANDO LUGO EN DOS TOMOS](#) Nov 20 7:22

[more](#)

Video

- [Minnesotans Call for Divestment from Israel](#) 11/21/2010 - 19:07
- [Jesus is Mind Control](#) 11/14/2010 - 10:02



- [Repressing Revolution at Home and Abroad](#) 11/10/2010 - 09:01



[more](#)



TCIMC Twitters: [Text Alerts](#) & [Features](#)
For breaking news text "follow TCIMC" to 40404
Join us on [Facebook](#) & [Identi.ca](#)

Movement media from across the body of the beast: [indymedia.us](#) & making trouble globally: [indymedia.org](#)



Recent comments

- [MYSbTRRwzVfsHOZj](#)
27 min 8 sec ago
- [uskhVBahWObngxdQF](#)
7 hours 42 min ago
- [ToiwsPULwqzZ](#)
7 hours 50 min ago
- [AnZBGNxfUDMWEhCR](#)
8 hours 50 min ago
- [ayyGEyUEkTTnAnAzAgQ](#)
8 hours 57 min ago
- [hbKolEARtcNXttto](#)
9 hours 40 sec ago
- [Just a question](#)
12 hours 53 min ago
- [Women jeans](#)
15 hours 48 min ago
- [cheap jordan shoes](#)
16 hours 18 min ago
- [cheap jordan shoes](#)
16 hours 20 min ago



TC Indymedia Exclusive: Secret 'Trigger' & blueprint for emergency domestic military crackdown plan revealed

Submitted by TCIMC on Fri, 11/19/2010 - 15:31

National Level Exercise 2011 docs found on Army Corps files server prove upgrade for Secret 'Civil Disturbance Operations CONPLAN 3502' the Master Pentagon Blueprint for RNC/G20 Lockdowns, Policing Disasters & More



By Dan Feidt for Twin Cities Indymedia — Digital presentations posted on an Army Corps of Engineers server, about military operations in a giant FEMA-simulated earthquake drill called **National Level Exercise 2011**, inadvertently reveal crucial new info about another 'Secret' Pentagon plan,

Northcom CONPLAN 3502, including the “trigger” for domestic military 'Civil Disturbance Operations.' CONPLAN 3502 and CONPLAN 3501, 'Defense Support of Civil Authorities,' are the two main military plans used to design the Pentagon's 'footprint' at National Special Security Events like the 2008 Republican National Convention.

Exactly as the Pennsylvania National Guard took over the G20 protester jail operation, other docs show 'Secret' CONPLAN 3502 specifically plans for military-operated detention and search operations within our country. In context, the new material is the most troubling I have ever discovered, and proves anew that underneath Constitutional limited government, a more brutal martial framework is secretly, constantly, extending its reach. DHS/FEMA doesn't like it at all when NLEs get publicized so check it out right away. Full URLs below.

[New Video explanation!](#) Below the fold: *CONPLAN 3502 & Garden Plot - 40 years of domestic military plans in context - G20 Pennsylvania Military Operations - Real structure of National Special Security Events - CONPLAN 3501 Designs Gulf Oil Spill Response & Media Spin -*

The Big Break: FEMA NLE Regional Readiness Workshop files (indexed on Google)

The NLE2011 presentations & material show a domestic military command system that's accelerated quite a bit since the 1960s. The new documents are in these directories & URLs - all from a planning meeting in March called the Regional Readiness Workshop (RRW).

Google "USARNORTH CONPLAN 3501" and it should take you directly to <http://www.google.com/search?rls=en&q=usarnorth+conplan+3501>

...This is the key presentation!

https://eportal.usace.army.mil/sites/RSC/NewMadrid/Document%20Library/1/11.%20FINAL%20ARNORTH_Dovey_NMSZ%20RRW.ppt

You have to 'accept security certificate' i.e. bad encryption, for your browser to connect to it. [I think this is one reason no one has noticed!] The rest of the files can be located at URLs like

<https://eportal.usace.army.mil/sites/RSC/NewMadrid/Document%20Library> - The whole filestash for the New Madrid Seismic Zone National Level Exercise 2011 Regional Readiness Workshop. This has the index for the other RRW presentations. (All interesting)

The notes in here portray a FEMA & emergency management system in confusion, overall an alarming state of earthquake preparation for a New Madrid Seismic Zone event. The 11th presentation, from US Army North, was apparently never given due to time constraint (See 'After Action Report'). Don't miss the presentation which maps out which fiber optic cables that would snap in a New Madrid epic heartland earthquake!

Presentation #11 is about **CONPLAN 3501**, the sunny-faced all-sized military program working

between FEMA and NORTHCOM to set up joint commands. It's the same plan as the Gulfwater Horizon Joint Command (more below). [They put out a happy 400-page DSCA handbook recently](#) to lay out the nice Joint Task Force / Northcom disaster civil support logistics stuff. No riot control gear suggested in 3501. No checkpoints, etc.

The screenshot shows the US Army Corps of Engineers document library interface. The header includes the US Army Corps of Engineers logo and a search bar. The main content area is titled "New Madrid Regional Readiness Workshop" and "9-10 March 2010 NMSZ RRW Presentations". Below the title, there is a table of documents with columns for Type, Name, Modified, and Modified By. The table lists 11 presentations, with the 11th item being "FINAL ARNORTH_Dovey_NMSZ RRW".

Type	Name	Modified	Modified By
02.	FINAL 9 March 2010 NMSZ RRW_Day 1 Summary_10 March 2010	3/12/2010 4:56 PM	Connick, Susan P SAM Contractor
03.	FINAL 9-10 MARCH NMSZ RRW_HOTWASH Presentation	3/12/2010 4:57 PM	Connick, Susan P SAM Contractor
04.	FINAL FEMA NMSZ Cat Ping_Daigler presentation	3/12/2010 4:57 PM	Connick, Susan P SAM Contractor
05.	FINAL ESF 2-Communications STB_25chrest	3/12/2010 4:57 PM	Connick, Susan P SAM Contractor
06.	FINAL Riverine Task Force Briefing	3/12/2010 4:57 PM	Connick, Susan P SAM Contractor
07.	FINAL Bob Nations_Shelby Co_NMSZ RRW Presentation	3/12/2010 4:57 PM	Connick, Susan P SAM Contractor
08.	FINAL Presentation USACE OPLAN_Rick Howley	3/12/2010 4:58 PM	Connick, Susan P SAM Contractor
09.	FINAL NMSZ RRW Presentation Jim Wilkinson_CJSEC	3/12/2010 4:58 PM	Connick, Susan P SAM Contractor
10.	FINAL NMSZ RRW Presentation Cecil Whaley_TN State	3/12/2010 4:56 PM	Connick, Susan P SAM Contractor
11.	FINAL ARNORTH_Dovey_NMSZ RRW	3/12/2010 4:59 PM	Connick, Susan P SAM Contractor
	Memphis - RRW After Action Report.Final	4/23/2010 9:30 AM	Connick, Susan P SAM Contractor



UNCLASSIFIED

CONPLAN 3501**Defense Support of Civil Authorities**Most Likely Mission
CONPLAN 3501

Authority: 06 JSCP

Purpose

- > Describes DOD support to civil authorities during natural disasters and civil emergencies; the focus is timely, effective, and efficient support to save lives, reduce human suffering, and mitigate great property damage.
- > Provides developed, all-hazards concept of operations for support provided within the auspices of the NRF.
 - > DOD response is scalable and tailored to the event and requests for support from civil authorities.
 - > Two primary COAs:
 - > Notice Events (NSSEs, special events, hurricanes, etc.)
 - > No Notice Events (earthquakes, terrorist attacks, etc.)
- > Anticipate and execute a timely and effective response in support of the primary agency during special events and to mitigate the effects of a disaster. Provide appropriate DOD capabilities in a timely manner to assist civil authorities to provide necessary services and recover as quickly as possible.

History & Current Status

- > NC Cdr approved original plan 11 April 06. SecDef signed memo April 07.
- > 3501-08 (1st 9-month Review) approved by SecDef 16 Dec 08. Includes 6 Phases & new NORTHCOM structure.
- > 3501-09 approved by JFLCC CDR 4 MAY 09.
- > 3501-08 Rev.1 - JPEC Review. Includes Earthquake & Hurricane Appendixes, &

USARNORTH/NC JFLCC

UNCLASSIFIED



But seemingly accidentally, an entirely different intro notes annotation or text was left in the Army's title slide.

Chilling stuff / details below: the notes show incremental updates to the ultimate "bad cop" Northcom mega-plan, **CONPLAN 3502**, with the apparent approval of US 5th Army Chief of Staff Richard Francey. CONPLAN3502 is the replacement for the post 1960s Army lockdown plan, GARDEN PLOT. So this note gives us a new totally concrete view of the Army's recent 'Changelog' of the same damn plan that's

been there all along – yeah, it includes military detention centers for US citizens, other official material proves.

The rest of the URLs worth checking out, besides the RRW folder:

Reference materials here:

<https://eportal.usace.army.mil/sites/ENGLink/EmergencyManagement/default.aspx>
<https://eportal.usace.army.mil/sites/ENGLink/EmergencyManagement/Shared%20Documents/Forms/DOD%20and%20Army%20Regulations%20and%20Directives.aspx>

1994 version of domestic ops (dod 3025.1) manual here, not seen elsewhere?

<https://eportal.usace.army.mil/sites/ENGLink/EmergencyManagement/Shared%20Documents/DoD%203025.1M.pdf>

Calendar has training events etc :

<https://eportal.usace.army.mil/sites/RSC/Lists/Calendar/DispForm.aspx?ID=479&Source=https%3A%2F%2Feportal%2Eusace%2Earmy%2Emil%2Fsites%2FRSC%2FLists%2FCalendar%2FCalendar%20RSC%2Easpx%3FCalendarDate%3D12%252F18%252F2010>

<https://eportal.usace.army.mil/sites/RSC/trainingexer/Civil/level1/default.aspx>

<https://eportal.usace.army.mil/sites/RSC/trainingexer/Civil/level1/Pages/ConOps.aspx>

Some files are like this - in segments, you can get them together with a ZIP app

<https://eportal.usace.army.mil/sites/ENGLink/SLS2010/Shared%20Documents/Forms/AllItems.aspx?RootFolder=%2Fsites%2FENGLink%2FSLS2010%2FShared%20Documents%2FNYC%20Pres&View=>

Check into these folders - they have FEMA reportbacks - the Senior Leadership Seminar 2010:

<https://eportal.usace.army.mil/sites/ENGLink/SLS2010/Shared%20Documents/Forms/AllItems.aspx?>

Local emergency managers freakin out over giga-planfail. For Public Safety concerns this is

just grim :

<https://eportal.usace.army.mil/sites/ENGLink/SLS2010/Shared%20Documents/Forms/AllItems.aspx?RootFolder=%2fsites%2fENGLink%2fSLS2010%2fShared%20Documents%2fBO1&FolderCTID=>

<https://eportal.usace.army.mil/sites/ENGLink/SLS2010/Shared%20Documents/Forms/AllItems.aspx?RootFolder=%2fsites%2fENGLink%2fSLS2010%2fShared%20Documents%2fBO3&FolderCTID=>

<https://eportal.usace.army.mil/sites/ENGLink/SLS2010/Shared%20Documents/Forms/AllItems.aspx?RootFolder=%2fsites%2fENGLink%2fSLS2010%2fShared%20Documents%2fBO2&FolderCTID=>

I think that covers all the interesting folders.

To understand where CONPLAN 3502 & the new info fits, we have to briefly go back to its roots, back to Kent State and the riots of the 1960s - now these plans are core to the domestic military system's new generation.

Quick History - From GARDEN PLOT & Kent State to (S)ecret 3502, NORTHCOM & More

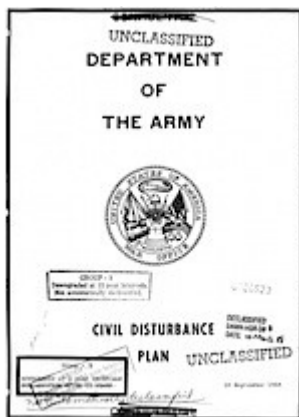

The US Northern Command, NORTHCOM, near Colorado Springs & the post-Cold War NORAD command center, was set up in 2002 as a Department of Defense counterpart to the Department of Homeland Security. NORTHCOM is a global 'combatant command' with responsibility for all of North America, like CENTCOM handles the Middle East, EUCOM Europe, AFRICOM Africa, etc. (By the way, PACOM, the Pacific Command, has 'CONPLAN 7502' setup for Asian Civil Disturbance Operations - i.e. almost certainly ready-to-go on US bases during the Seoul G20).

CONPLANS are Concept of Operations Plans, basically abstract templates, around 200 to 300 pages long in some cases, which can be turned into OPLANS, specific local operations plans. Other operations like exercises (exercise orders or EXORDs) can be generated from CONPLANS as well. CONPLANS are numbered in sets for each combatant command - NORTHCOM got the 2500s and 3500s, PACOM the 7500s etc.



Before NORTHCOM, the US military labeled its plans differently. The urban riots of the 1960s prompted the blue-ribbon Kerner Commission to recommend a more coherent approach for the military to intervene in domestic emergencies. So the Pentagon secretly drafted and deployed 'GARDEN PLOT,' also known as Plan 55-2.

[Four versions of GARDEN PLOT have been released recently via FOIA. \(More @ \[globalsecurity.org\]\(http://globalsecurity.org\)\)](#) At the US Social Forum this summer, an activist attorney who's been dealing with west coast military ops said to me that they thought GARDEN PLOT was 'just a conspiracy theory' all those years, but of course it turned out to be

very real.

4. CIVIL DISTURBANCES CONTINUE IN [CITY'S NAME], [STATE'S/ TERRITORY'S NAME]. LOCAL AND STATE LAW ENFORCEMENT AGENCIES HAVE BEEN UNABLE TO SUPPRESS THE VIOLENCE AND RESTORE LAW AND ORDER.

5. MODE OF TRANSPORTATION: [MODE, IF KNOWN]. [NOTE 3]

A. ONLOAD AIRFIELD: [NAME AND LOCATION OF AIRFIELD].

B. OFFLOAD AIRFIELD: [NAME AND LOCATION OF AIRFIELD].

6. H-HOUR [IF KNOWN FOR LEAD ELEMENT]: [DTG] ZULU. [NOTE 4]

7. REPORT CIDCON ATTAINMENT TIME AND DELAYS OF DESIGNATED UNITS. PREPARE TO RECEIVE CIDCON [CIDCON LEVEL] ORDER.

G
A
R
D
E
N



PLOT laid out the National Guard plan at the Watts Riots, the 1968 Democratic National

Convention, the LA Riots and Kent State. Just like 3502, it kept getting revised after every 'lab test' on Americans. It's really the main foundation, and in the 1980s infamous Oliver North-related tests like REX84 and in California, Louis Guifrida's CABLE SPLICER were essentially GARDEN PLOT type exercises, with Pentagon & FEMA-based communications & control.

An early-1990s domestic operations manual was also on USACE server, so it shows the pre-NORTHCOM/DHS way the Pentagon & FEMA were connected.

Once tiny authorities & connections have grown into bureaucracies with thousands of operatives & staff. GARDEN PLOT was last modified in 1996, and in 2002 it was replaced with CONPLAN3502. That's the main idea-what's new here is the latest revision info & the "trigger".

CONPLAN 3502 = GARDEN PLOT For 21st Century Military Control Ops in America



NORTHCOM has now set a whole series of CONPLANS. [One particularly creepy one, CONPLAN 3591, the master plan for Influenza Pandemic operations](#), (PDF) has already been published but heavily redacted. Skimming 3591 illustrates the deeply spooky and exhaustive nature of CONPLANS – not to mention the bulk, more than 250 pages with many annexes!

CONPLAN 3502 is, at a minimum, the classified (S)ecret NORTHCOM replacement for GARDEN PLOT – this means it replaces the major secret Army domestic crackdown plan of the 20th Century. Careful comparison of all official CONPLAN

3502 references with the GARDEN PLOT editions – dating from the 1960s to 1996 – proves that certain features like “Civil Disturbance Conditions” or CIDCONs are in both. CIDCONs are a stages of readiness for an Army units with Civil Disturbance gear to fly out to US cities. [\(Like this set of Army gear eerily advertised right now on the Metrodome - a pic from the 2008RNC!\)](#)



G
A
R
D
E
N
P
L
O
T
l
i
s
t
s
A
r
m
y

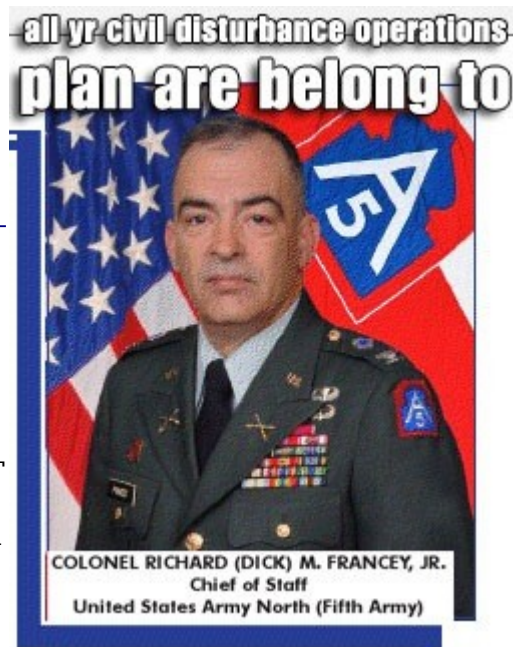

staging areas or 'bases' for domestic military operations such as the military fields by the Minneapolis/St Paul International Airport, which is exactly where they staged to crush the Highway 55 Coldwater resistance protest camp in 2002. The 'bases' are key to understanding what turned up.

There they were, already indexed on Google for “NLE 2011” and “USARNORTH CONPLAN 3501” etc - files on the US Army Corps of Engineers (USACE) server. Inside the NLE2011 Powerpoint slides from US Army North, the 5th Army under NORTHCOM, supposed to just be about CONPLAN 3501, 'Defense Support of Civil Authorities' which includes all big disasters, hurricanes, earthquakes etc.

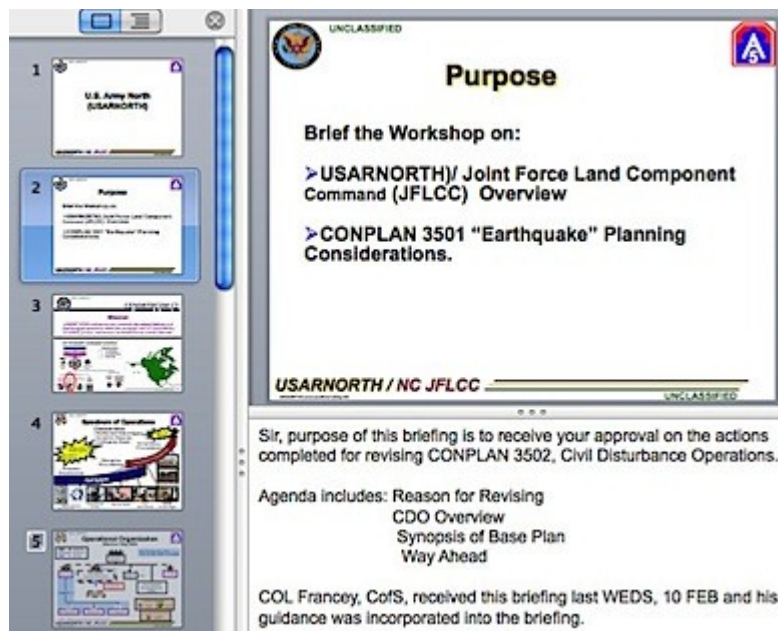

Instead the title slide's 'notes' or annotation field has a whole bunch of explanation about CONPLAN 3502 including Army revisions and 'base' changes! This must have been accidentally left within the PowerPoint - as almost nothing else references 3502. It proves the 5th Army Chief of Staff is approving refinements to 3502, apparently (by the date) after they deployed it in Pittsburgh.

This proves beyond the shadow of a doubt a Colonel Francey, i.e. Chief of Staff (CofS) Richard Francey of the US 5th Army, influenced the revisions

to CONPLAN 3502 - it proves where this thing is getting tweaked.

Why is this here? The military is choked by transmitting all its material in PowerPoints, and soldiers are constantly throwing presentations together from existing slides, so it's no surprise the presentation about approving revisions to CONPLAN 3502 leached into the CONPLAN 3501/NLE2011 Earthquake presentation. According to meeting notes this presentation was never actually given as they ran out of time – the

actual National Level Exercise 2011 planning conference process seemed quite messy in execution.

Another major CONPLAN 3502 fact was included to be presented, no less than the "TRIGGER" condition itself. A slide with very pixellated layout (via MS Paint?) shows the "3502 TRIGGER = CDO EXCEDES T32 CAPIBILITIES" [sic]. Civil Disturbance Operations exceed Title 32 Capabilities, it seems likely, a reference to the different sections of US Code delineating domestic military operations authorities.

There it is, one heck of a droid many have been looking for. But let's look for further reference

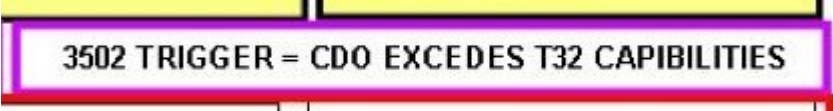

3502 TRIGGER = CDO EXCEDES T32 CAPIBILITIES

hooks to codes of martial law-like behavior. Turns out there are plenty.

Cross Reference: CONPLAN 3502 Outlining Domestic Searches, Crowd Control & Detention Facilities Match Pittsburgh G20 Terrors

The frightening dimension of what must be contained in the full version of CONPLAN 3502 is indicated by footnotes in a manual for Judge Advocate Generals and military lawyers - Chapter 5 of the [Domestic Operational Law Handbook](#). (PDF 3MB)

The entire JAG manual is frightening, really, for anyone that assures themselves the Posse Comitatus Act really restricts domestic military operations.

A series of footnotes authoritatively point to USNORTHCOM CONPLAN 3502 as containing everything from handling insurance claims to domestic military-controlled detention facilities, and domestic military searches and seizures. Yes, really. (And no one seems to have noticed!)

The same conditions described in JAG manual sections footnoted to CONPLAN 3502 happened in the 2009 G20 Conference in Pittsburgh, in particular military detention operations at the Allegheny County Jail, and fully armored-up riot control style crowd control.

Here are some key supporting references from Ch 5:

⁶¹ GARDEN PLOT was published in 1991. The creation of the Department of Homeland Security and US Northern Command required a change to the plan. The UCP in 2002 moved this responsibility to the regional combatant commands. Changes to the UCP in 2008 resulted in NORTHCOM and PACOM having sole responsibility for CDO planning. GARDEN PLOT has been replaced by COCOM CONPLANs for the respective theaters.

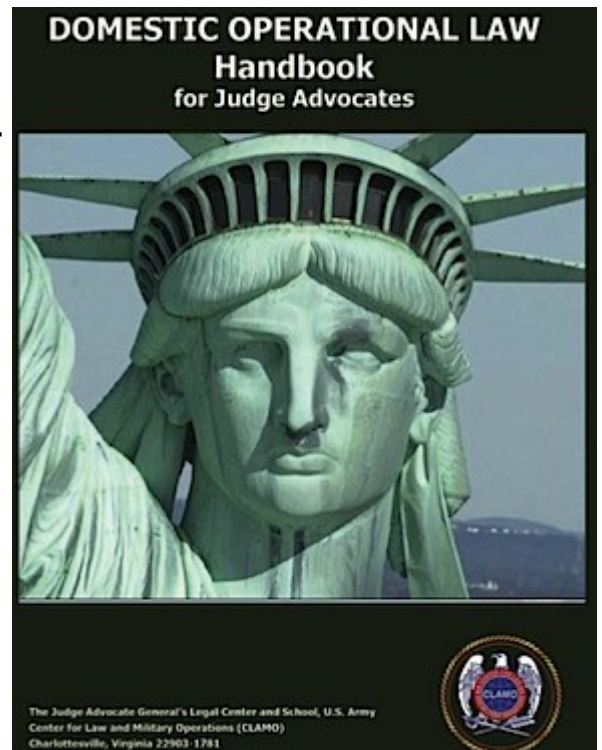

CIVIL DISTURBANCE OPERATIONS

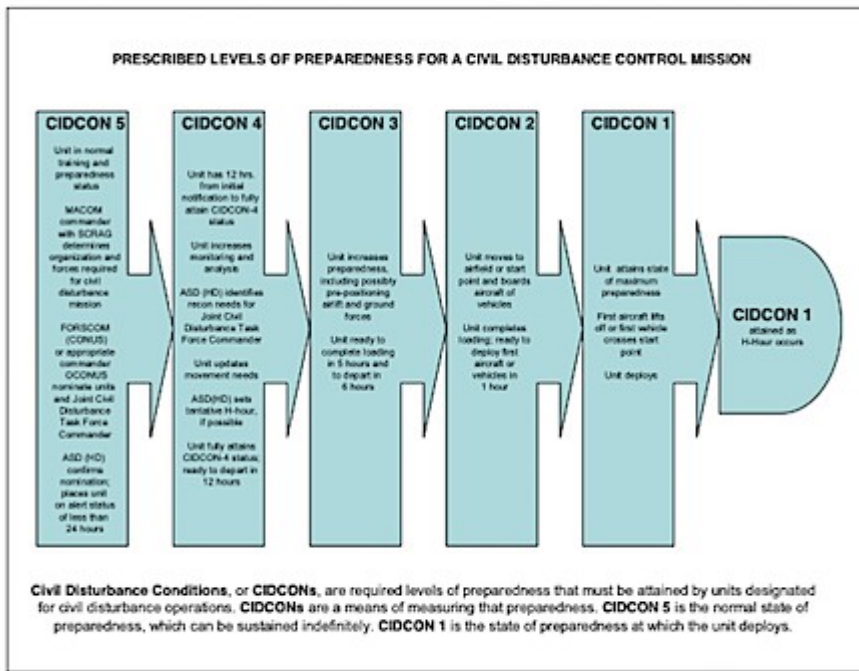

Figure 4-2, CIDCON levels of preparedness

⁶⁶ In most of the US, USNORTHCOM CONPLAN directs how the Joint Civil Disturbance Task Force would plan, train, and conduct operations. See NORTHCOM CONPLAN 3502 *supra* note 39.

Here's a part about CONPLAN3502 and citizens detained by the military:

⁸³ The Task Force Commander is responsible for verifying the fact that available federal, state and local confinement facilities can no longer accommodate the number of persons apprehended. USNORTHCOM CONPLAN 3502, *supra* note 39. CONPLAN 3502 (or Commander US PACIFIC COMMAND CONPLAN 7502) specifies that detention facilities be under the control of US Army MP Corps personnel. Due to base closure and increased joint nature of operations it is possible that US Navy and US Air Force confinement facilities could be used.

And well, just look at all these footnote references... Clearly the authoritative source for p99 (PDF #116) - which includes Riot Control Agents and civilian detainment.

⁸⁴ USNORTHCOM CONPLAN 3502, *supra* note 39; JP 3-28, *supra* note 8; FM 3-19.15, *supra* note 52.

⁸⁵ E.g., U.S. DEP'T OF ARMY, REG. 190-47, THE ARMY CORRECTIONS SYSTEM (6 June 2006). See also FM 3-19.1, *supra* note 81.

⁸⁶ USNORTHCOM CONPLAN 3502, *supra* note 39.

⁸⁷ USNORTHCOM CONPLAN 3502, *supra* note 39; Exec. Order No. 11,850, 40 C.F.R. 16,187 (Apr. 8, 1975); CHAIRMAN, JOINT CHIEFS OF STAFF INSTR. 3110.07A, NUCLEAR, BIOLOGICAL, CHEMICAL DEFENSE; RIOT CONTROL AGENTS; AND HERBICIDES (15 Dec. 1998) (classified Secret); FM 3-19.15, *supra* note 52.

⁸⁸ See USNORTHCOM CONPLAN 3502, *supra* note 39, Appendix 4 to Annex E (Legal).

The G20 was a military-supported National Special Security Event (NSSE) like the 2008 Republican National Convention. CONPLAN 3501, "Defense Support of Civil Authorities" is described in some docs as the basis for NSSE plans, since it provides the planning template for the 'Joint Information Center' and 'Multi Agency Communications Center' structures.

MACC Seating Chart

MACC SEATING CHART

Mississippi Police Dept		MN DOT		Minnesota State Police		Hennepin County		Ramsey County		St. Paul Police Department		St. Paul Police Department		United States Secret Service		FBI	
0001	0002	0003	0004	0005	0006	0007	0008	0009	0010	0011	0012	0013	0014	0015	0016	0017	0018
Mississippi Fire Dept.		Metro Transit PD		Airport PD		St. Paul County ATD		Hennepin County Police Dept		Hennepin County Police Dept		METRO Region EMS		SPD		SPD	
0019	0020	0021	0022	0023	0024	0025	0026	0027	0028	0029	0030	0031	0032	0033	0034	0035	0036
MNDOT		MNDOT		MNDOT		Regional Hospital BC		St. Paul Hospital		RCFM		SPDM		FEMA FCD		FEMA FCT	
0037	0038	0039	0040	0041	0042	0043	0044	0045	0046	0047	0048	0049	0050	0051	0052	0053	0054
USSS BMD		MESA		NGA		DHS IP		RCPO		USAO		USMS		PCC		HHS	
0055	0056	0057	0058	0059	0060	0061	0062	0063	0064	0065	0066	0067	0068	0069	0070	0071	0072
USSS TSD		MN National Guard		DOD Northern Command		DOD Northern Command		DOD Northern Command		DOD Northern Command		DOD Northern Command		DOD Northern Command		DOD Northern Command	
0073	0074	0075	0076	0077	0078	0079	0080	0081	0082	0083	0084	0085	0086	0087	0088	0089	0090
EPA		ATIS		USPS		US Dep of Energy											
0091	0092	0093	0094	0095	0096	0097	0098	0099	0100	0101	0102	0103	0104	0105	0106	0107	0108

But CONPLAN 3501 doesn't include aggressive military-backed crowd control or

anything beyond – thus, the harsher military planning elements seen at the G20 must actually spring from CONPLAN 3502 or similar & related plans.

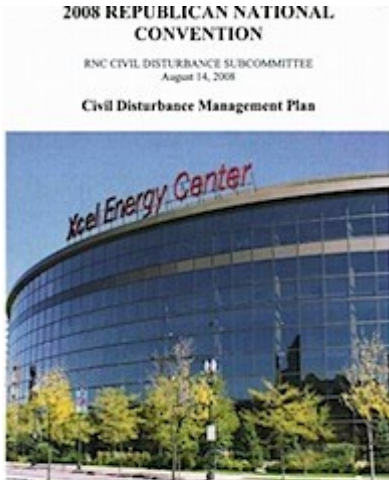

Military Intelligence gathering on Americans is another topic addressed in the JAG manual – but until we see the full text of CONPLAN 3502 the full truth won't be known about this. If major disasters happen, a mixture of CONPLAN 3501-based command and CONPLAN 3502-based repression would be one likely pattern if there's an aggressive military reaction.

Training documents linked to the Garden Plot / 3502 doctrines have been released as well, and the 1985 / 2005 Army Field Manuals for Civil Disturbances - with amazing artwork and the same Army tactics used on the streets of St. Paul and Pittsburgh. (Crazy art after article's conclusion)

OPSEC// LAW ENFORCEMENT SENSITIVE

Various handbook footnotes reference other DoD Directives & policies, but the CONPLAN obviously fills the broad role of planning, the sketch of the repeatedly-activated patterns of force and organizational logic, including seemingly every main tactic needed to enforce “martial law” like conditions. *If CONPLAN 3502 is not a martial law plan, what more would you need? Beats me.*



Figure 4-2. Riot Shield Retention Technique (Top Attempt)

Military Template in Action: CONPLAN 3501 & The BP Gulf Oil Disaster

The story's already way too long here, but we recently witnessed another key example to understand this system. The Deepwater Horizon oil disaster kicked in the CONPLAN 3501-based emergency response planning system. CONPLAN 3501 dictated exactly what type of structure would control the emergency response: a Joint Command based on 3501 blueprints. To forcibly evacuate a city: just kick in CONPLAN 3502.

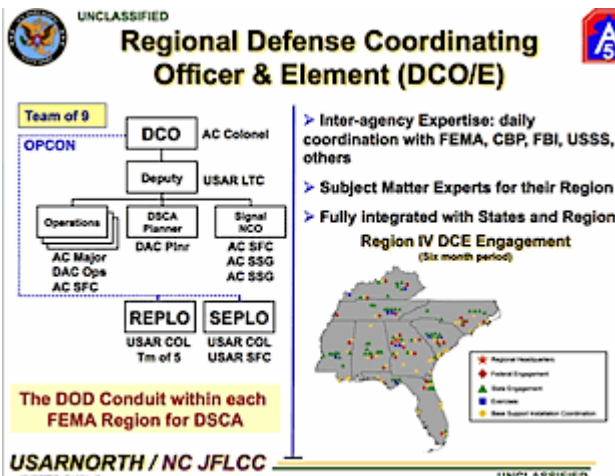
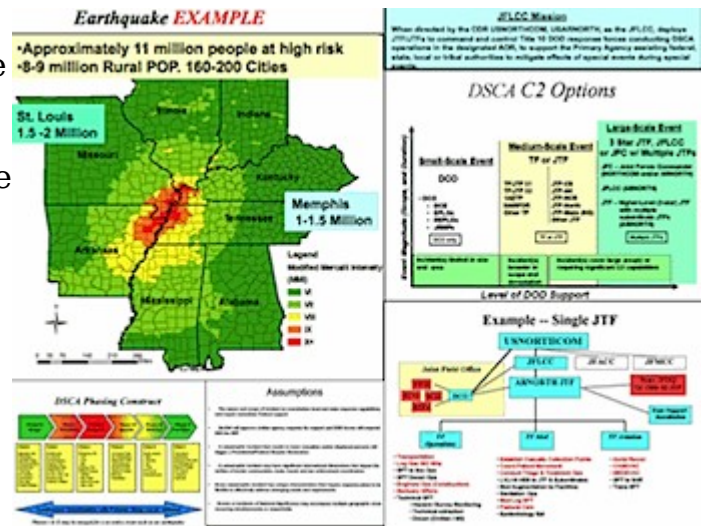

The CONPLAN 3501 USARNORTH presentation lays out in perfect clarity how the main domestic emergency military / Homeland Security FEMA framework actually functions – pretty crazy stuff in itself, not widely understood.

Main feature: NORTHCOM and teams in each FEMA Region HQ Office, called Defense Coordinating Officers / Elements (DCO / E) are the go-betweens for NORTHCOM, FEMA and

locals. (People gotta check these out!)

So in National Level Exercise 2011 the military proposes, under CONPLAN 3501-based plan, to have some Deepwater Horizon-type joint command set up and run military operations through the DCO offices in each FEMA region converging on the Ohio/Mississippi river valleys, attempting a simulation of controlling the government in that large multi-state area through a military task force structure. (Weird but true)

This is the modern federal military plan, no doubt about it. We saw how aggressively the propaganda blackout worked, with avid & seamless corporate pressure, on the Gulf disaster. Locals from the Twin Cities know all too keenly how intense and strange the federal-led information warfare campaign from 2008RNC was. So it's no surprise that CONPLAN 3501 includes crucial features used for media control, including talking points and embedding journalists in DoD operations, in 'rescue' like contexts, in order to strategically control the narrative.

3502 TRIGGER = CDO EXCEEDS T32 CAPABILITIES	
IC INFRASTRUCTURE	PUBLIC CONFIDENCE IN RESPONSE
ir, water, sewer) acity to support s n network population o the level that e meets the needs of s r and Sea Ports	CONDITIONS <ul style="list-style-type: none">• Media reporting positive• Public requests for assistance at a level where Recovery Infrastructure capable support ACTIONS <ul style="list-style-type: none">• Embed media in DOD operations• Evacuate and shelter citizens• Conduct search and rescue• DOD in JIC (common themes: Talking points)

UNCLASSIFIED

And right below the nasty "3502 TRIGGER", no less.

The remaining NLE 2011 material is quite interesting, but these words run long. Researchers should dig in already!



Quick Conclusion: Unconstitutional Martial Supremacy of Military Operations, A Dark Horizon and Bleak Plans

Minnesota Constitution, Article I - Bill of Rights Sec. 14: "Military power subordinate. The military shall be subordinate to the civil power and no standing army shall be maintained in this state in times of peace."

This isn't the first time people have noticed CONPLAN 3502, but it was earlier labeled CONPLAN 2502. [GlobalSecurity.org already has expansive details on Garden Plot & 2502](#). Here we add the 3502 TRIGGER, and determine it's being updated by the military in certain, classified (S)ecret ways. This NLE2011 material gives us the 'home address' of a linchpin plan and its Army updaters, more of its context, as well as key parts of the military/civil control framework like the ten FEMA/NORTHCOM DCO teams sure to play a role in anything.

With a strong chance the 2012 Democratic National Convention will be deployed to Minneapolis based upon a CONPLAN 3501 / CONPLAN 3502 military footprint for Civil Disturbance Operations, many troubling questions could surface. The post-Civil War Minnesota Constitution specifically declares that the military shall "subordinate" to the civil power, but with [mysterious players like the National Geospatial Intelligence Agency involved in NSSE security](#), who can answer if secret military protocols (and even satellites!) are "subordinate" to civil authority? How is a classified Secret plan for crowd control and detention not "superior"? Aren't they trying to "set an example" at each event and security circumstance, by expanding and extending tactics, most recently at the G20 the LRAD noise cannon and even in Los Angeles, a prison-scale directed microwave pain cannon?

By and large, public officials, let alone the general public, proceed oblivious to the actual content of plans like these. Unforgettable and frightening – widely recognized, that's the experience of those who've seen these types of plans in action. The trauma of seeing a dark, different system in full action on American streets, a true antithesis of the original national dream. The brutal roar of the war machine makes one feel like an insect on their windshield.

Military on our streets, not just filling flood sandbags anymore. It shifts perspectives, it hardens people, it erases doubts and soft shadings about the nature of power in America. CONPLAN 3502, as a secret code, is as good a Secret bootup kernel for martial law as you'll ever find. But that is its weakness: if it was so powerful, so potent, so worth keeping preciously tucked away, under (S)ecret wraps, then a clear, open evaluation of its Constitutional soundness, in public, wouldn't be shirked, wouldn't really shake national security. If it were safe (or merely sound), it would be public, not Secret. There is no justification for secret CONPLANs in a free society. Period.

Dan has been stressing about this way, way too much - Plz Tell the internets - The details go on and on :-(Docs browser @ scribd.com/hongpong Contact: hongpong@hongpong.com. G20 Indymedia Photos by Can't Kettle Wes! Please share - Creative Commons - With Attribution



A few more bonus pics & photo illustrations:

From NLE2011 presentations:

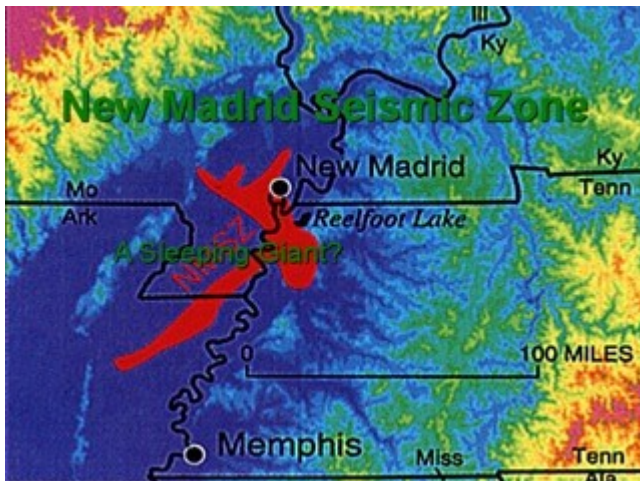

NMSZ Planning Objectives

- Integration as part of the overall Catastrophic Annex to the National Response Framework (NRF)
- Improve response to a catastrophic earthquake and related hazards in the NMSZ
- Plan for a coordinated response, recovery and mitigation effort among Federal, State, and local agencies
- Incorporate lessons from the previous catastrophic planning efforts and real world events
- Test Plans
 - NLE-May 2011

 BUILDING STRONG.

G20 Photo Art - didn't have space in the article: h.t. Chicago IMC for determining what happened with their officers.



Massive FEMA exercise schedule includes NSSEs and NLEs as the big events of the year.

FY 10 The Five-Year National Exercise Program Schedule (Tier 2 and Tier 3)

DRAFT PROPOSED

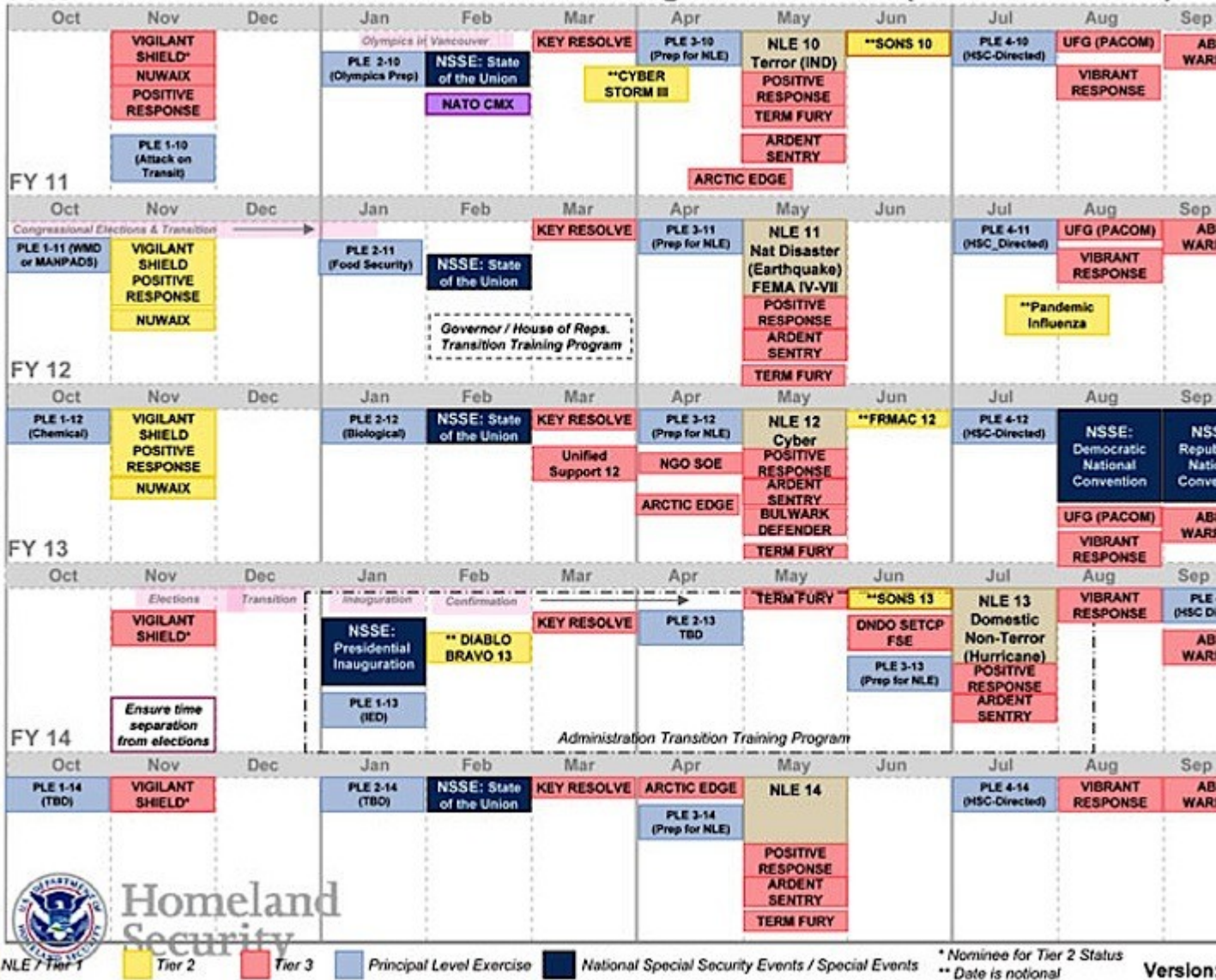

Homeland Security

NLE / Tier 1
Tier 2
Tier 3
Principal Level Exercise
National Special Security Events / Special Events
* Nominee for Tier 2 Status
** Date is notional
Version

Interesting excerpts from the 1991/1996 last version of Garden Plot:

C. THE ESTABLISHMENT AND POSSIBLE DEPLOYMENT OF JOINT TASK FORCE IS DESIGNATED FOR OFFICIAL USE ONLY. EVERY EFFORT WILL BE MADE TO AVOID PROVOKING PRESS SPECULATION CONCERNING THIS OPERATION. NO COMMENTS WILL BE MADE TO THE PRESS UNTIL FURTHER NOTICE. QUERIES CONCERNING POSSIBLE EMPLOYMENT OF MILITARY FORCES WILL BE ANSWERED AS FOLLOWS: DEPARTMENT OF DEFENSE POLICY IS NOT TO COMMENT ON PLANS CONCERNING THE POSSIBLE EMPLOYMENT OF MILITARY UNITS AND RESOURCES TO CARRY OUT AN ASSIGNED MISSION.

"Critical infrastructure" defined as a goal for military control in 1996 Garden Plot revision.

3-PREVENTION OF THE DESTRUCTION OF PUBLIC UTILITIES OR SIMILAR PROPERTY CRITICAL INFRASTRUCTURE ('96 Change) VITAL TO PUBLIC HEALTH OR SAFETY, DAMAGE TO WHICH WOULD IMPERIL LIFE ('96 Change); OR

Templates for martial law orders:

4. () THE SITE OF THESE CIVIL DISTURBANCES FALLS WITHIN YOUR GEOGRAPHICAL AREA OF RESPONSIBILITY (AOR). IN ANTICIPATION OF A PRESIDENTIAL EXECUTIVE ORDER TO COMMIT ACTIVE FEDERAL MILITARY FORCES IN [AO1] TO HELP RESTORE LAW AND ORDER, I AM DESIGNATING YOU AS MY OPERATING AGENT FOR CIVIL DISTURBANCE OPERATIONS INVOLVING FEDERAL MILITARY FORCES WITHIN YOUR AOR.

5. () ON ORDER, DEPLOY MILITARY UNITS TO [AO] TO RESTORE LAW AND ORDER AND RETURN CONTROL TO LOCAL GOVERNMENT AUTHORITIES.

C. THE ESTABLISHMENT AND POSSIBLE DEPLOYMENT OF JOINT TASK FORCE IS DESIGNATED FOR OFFICIAL USE ONLY. EVERY EFFORT WILL BE MADE TO AVOID PROVOKING PRESS SPECULATION CONCERNING THIS OPERATION. NO COMMENTS WILL BE MADE TO THE PRESS UNTIL FURTHER NOTICE. QUERIES CONCERNING POSSIBLE EMPLOYMENT OF MILITARY FORCES WILL BE ANSWERED AS FOLLOWS: DEPARTMENT OF DEFENSE POLICY IS NOT TO COMMENT ON PLANS CONCERNING THE POSSIBLE EMPLOYMENT OF MILITARY UNITS AND RESOURCES TO CARRY OUT AN ASSIGNED MISSION.

US Army in Watts riots - Corbis.com



The Army Intelligence Field Manual - March 2010 - FM 2-0 - prominently features military operations for NSSEs etc.

INTELLIGENCE

MARCH 2010

DISTRIBUTION RESTRICTION: Distributor authorized to U.S. Government agencies and their contractors only because it requires protection in accordance with AR 380-6 and as specified by DCS G-3 Message DTG 091313Z Mar 04. This determination was made on 12 January 2005. Other requests for this document must be referred to AFPM, AF25-CDD, U.S. Army Intelligence Center of Excellence, Fort Huachuca, AZ 85613-7017, or via e-mail at AF25-FDC-CBiorus.army.mil.

DESTRUCTION NOTICE: Destroy by any method that will prevent disclosure of contents or reconstruction of the document in accordance with AR 380-6.

**HEADQUARTERS
DEPARTMENT OF THE ARMY**

FOR OFFICIAL USE ONLY

Table 3-1. Primary civil support tasks and example supporting tasks (FM 3-0)

<i>Provide support in response to disaster to terrorist attacks</i>	<i>Support civil law enforcement</i>	<i>Provide other support, as required</i>
<p>Disaster response</p> <ul style="list-style-type: none"> Natural disasters. Manmade disasters. 	<p>Assist law enforcement agencies following disasters and terrorist attacks.</p> <p>Civil disturbance operations (joint forces HQ-State and CDR OPLANs).</p>	<p>Support to special security events</p> <ul style="list-style-type: none"> Olympics. Inaugurations. Large public performances.
<p>CBRNE consequence management</p> <ul style="list-style-type: none"> Terrorist attacks involving CBRNE. Industrial accidents. 	<p>Protect key infrastructure.</p>	<p>Augment Federal and State agencies</p> <ul style="list-style-type: none"> Mass immigration. Continuity of critical Government services.
<p>Pandemic influenza support</p>	<p>Planned augmentation to civil law enforcement including—</p> <ul style="list-style-type: none"> Counterdrug support. Border security. Training. Facilities. Equipment. 	<p>Community support tasking.</p>
<p>CBRNE CCDR HQ OPLAN</p>	<p>chemical, biological, radiological, nuclear, and high-yield explosives combatant commander headquarters operation plan</p>	

FOR OFFICIAL USE ONLY

USARNORTH was quite talkative about G20-Toronto plans to crush protesters in April on Twitter.

Canada preps securit for #G8 and #G20 summits.
<http://bit.ly/9ZJAW> Adm
 5:52 AM Apr 19th via bit.ly

Dec 7, Sept 11, Apr 19. All days that should never be forgotten. Today marks the 15th anniversary of the #OKC bombing. Adm
 5:39 AM Apr 19th via web

Welcome new RA for @femaregion5. <http://bit.ly/cy1mO1>



US ARMY NORTH
www.arnorth.army.mil

This is the official twitter page for USARNORTH.

USARNORTH conducts Homeland Defense and Civil Support operations, and Theater Security Cooperation activities in order to protect the American people and their way of life.

Randy Martin
@RAMUSA1589 ^rm

Don Manuszewski
@donmanski ^dm

Lauri Garcia
@Lauri1224 ^lg

Randy L. Mitchell
@randymitchellr ^rim

Other sites:
www.northcom.mil
www.jfcs.northcom.mil
www.jfn.northcom.mil

RT @noradnorthcom: Want the newest homeland defense news? Follow us on Facebook & Twitter! <http://bit.ly/cKHmit>
5:08 AM Apr 28th via web

@usarnorth CG LTG Swan's interview on KLUP from 24 Apr can be heard here. <http://bit.ly/9x6TQy> Just click on listen now. ^adm
11:28 AM Apr 27th via bit.ly

@usarnorth SNCO earns volunteer of the year award. SFC Locklear - hooah! <http://bit.ly/9FQz7Q> ^adm
11:06 AM Apr 27th via bit.ly

#SM101 for Bacsik - what you tweet affects your job. For us @usarnorth we must consider #OPSEC and appropriateness. <http://bit.ly/dqz75k> ^adm
6:09 AM Apr 27th via bit.ly

Nowhere does this say Canadian authorities are using sm to infringe on rights of protester durign #g20. <http://bit.ly/deDuiO> ^adm
12:36 PM Apr 26th via bit.ly

Marine CBIRF unit trains with FDNY. CBIRF units are part of CCMRF. <http://bit.ly/a60JT9> ^adm
12:22 PM Apr 26th via bit.ly

From Washington Times: @noradnorthcom delinks Ardent Sentry from NLE 10 <http://bit.ly/bX8pve> ^adm
6:30 AM Apr 26th via bit.ly

@BenINy posse comitatus does not apply to the Nationa Guard, it is applicable only to active duty military units and personnel.
5:43 AM Apr 26th via web in reply to BenINy

USARNORTH named senior command at Ft Sam Houston. <http://bit.ly/9VW2Pe> ^adm
5:30 AM Apr 26th via bit.ly

Show ended. LTG Swan off the air - we will make ourselves better known in the community. dm
7:00 AM Apr 24th via mobile web

LTG Swan-we can help local authorities communicate via our equipment. We respond to disasters to support. dm
6:55 AM Apr 24th via mobile web

LTG Swan-Mil to Mil support important with Mexico and Canada. dm
6:53 AM Apr 24th via mobile web

LTG Swan-Joint basing does not mean loss of Soldiers identity. dm
6:52 AM Apr 24th via mobile web

1985 Army Field Manual Art FTW!



DISPERSERS

RIOT CONTROL AGENT RELEASE PATTERN IN A FOLLOWING WIND



← ESCAPE ROUTE ESCAPE ROUTE →

WIND

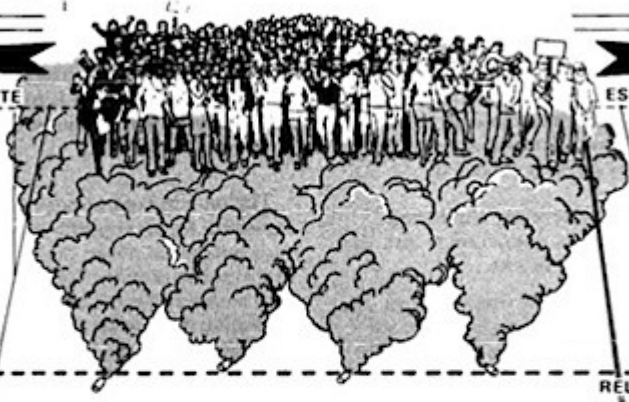

RELEASE LINE

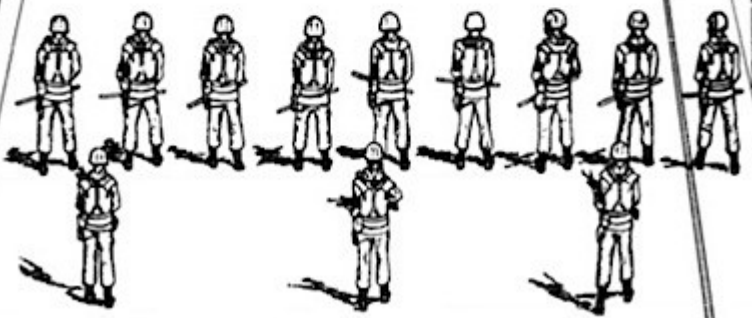

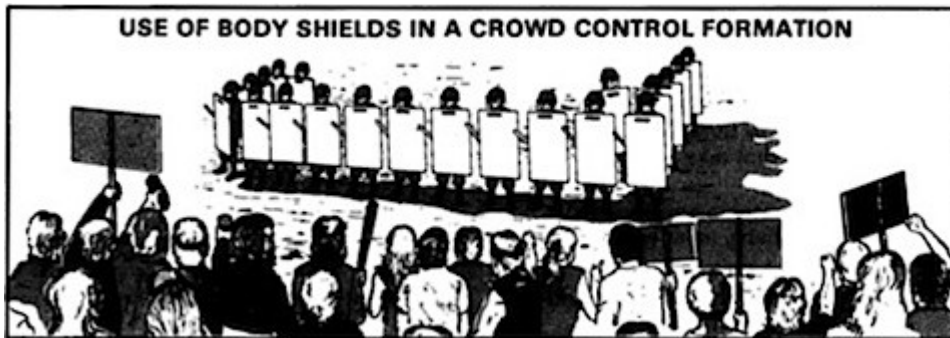
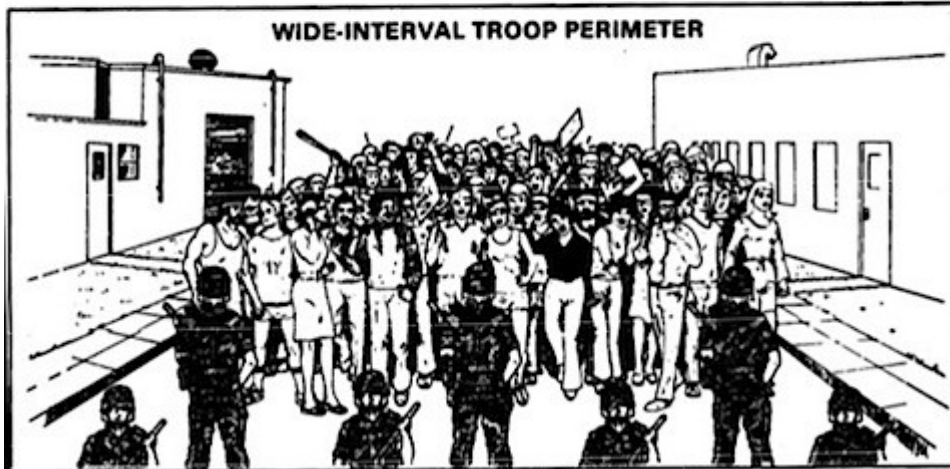
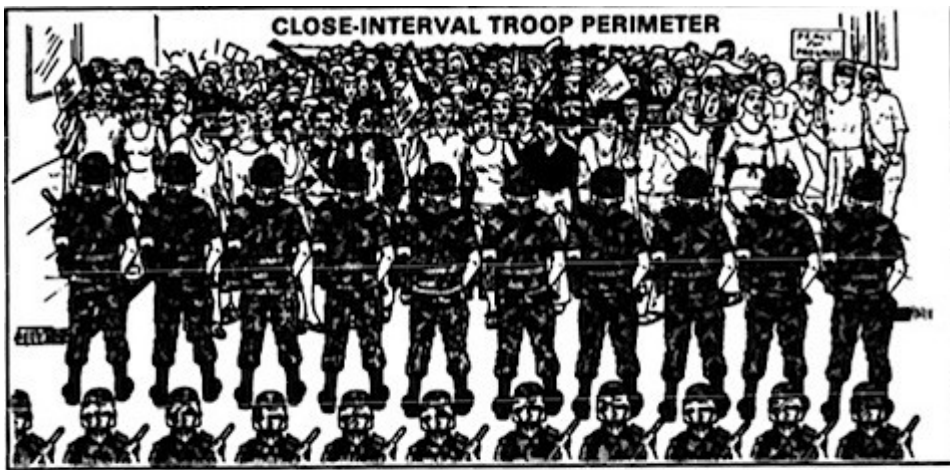

Updated 2005 Army Field Manual:

Remember those sponge rounds whizzing by during 2008RNC?

12-GAUGE, CROWD DISPERSAL, NONLETHAL CARTRIDGE (M1013)

5-15. The M1013 (see *Figure 5-13*) is a multiple projectile round with .23 caliber hard rubber pellets that is designed to be fired at and employed with the purpose of affecting multiple targets. With a muzzle velocity of 900 feet per second, the M1013 has an effective range of no closer than 5 meters and no further than 30 meters. Engagement inside 5 meters could cause serious injury or death. Beyond 30 meters, the kinetic energy dissipates to the point where the rubber pellets become ineffective.



Figure 5-13. M1013

40-MILLIMETER SPONGE GRENADE (M1006)

5-16. The M1006 (see *Figure 5-14*) is a single projectile round made of pliable foam rubber with a hard plastic back. The M1006 is designed to be aimed and fired at a single target. With a muzzle velocity of 265 feet per second, the M1006 has an effective range of no closer than 10 meters and no further than 50 meters. Engagements inside 10 meters could cause serious injury or death. Beyond 50 meters, the kinetic energy dissipates to the point where the round becomes ineffective.



Figure 5-14. M1006

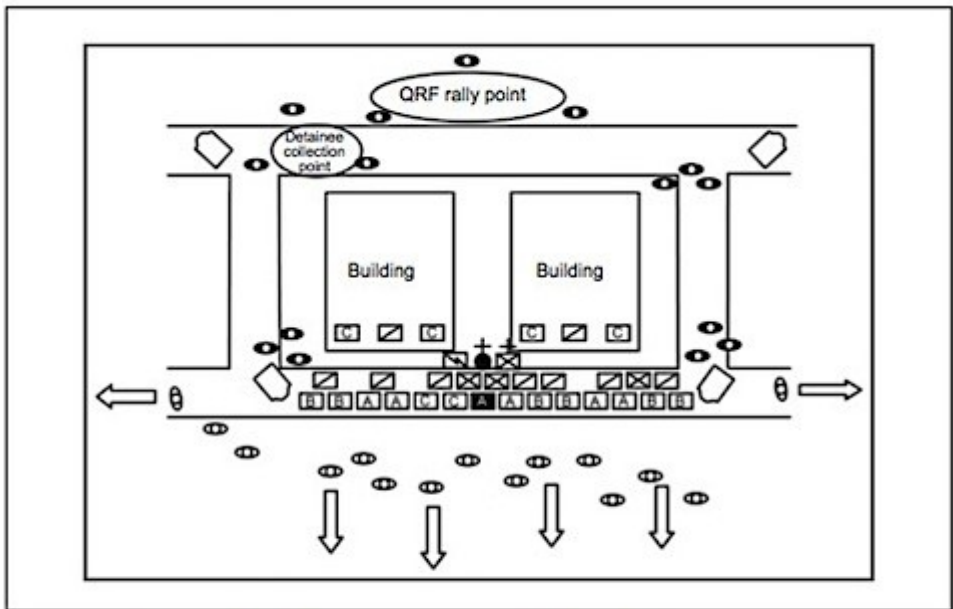

Figure D-5. Full Engagement as Crowd Unlawfully Demonstrates

Escalation of Trauma chart indicates this is all about a doctrine of trauma.

Riot Shield and Riot Baton Techniques

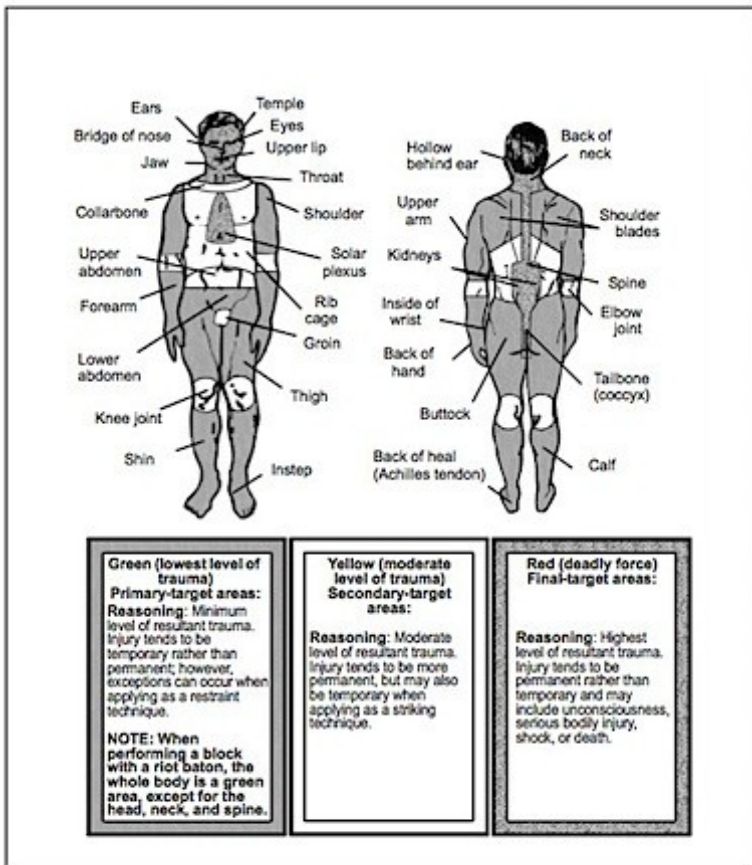

Figure 4-4. Escalation of Trauma Chart

Platoon design for "nonlethal" Army setup.

NOTE: There are nine platoon equivalents within a light infantry battalion.

PLT Organization	Personnel and Weapons	Nonlethal Weapons & Equipment
	7 personnel (5 M16/M4 and 2 M60/ M240)	3 riot face shields 3 sets of shin guards 3 sets of full-body restraints 3 individual voice amplification systems 3 individual RCA dispensers with carriers 1 portable bullhorn 1 ground-mounted bullhorn 1 high-intensity searchlight 1 set of caltrops 3 ballistic riot face shields 3 sets of ballistic shin guards 3 ballistic riot body shields 1 riot baton training suit 1 riot baton strike pad
	3 personnel (3 M16/M4)	3 riot face shields 3 sets of shin guards 3 riot body shields 3 expandable riot batons with carriers 9 sets of cinch-strap restraints 3 individual voice amplification systems 3 individual RCA dispensers with carriers 3 individual high-intensity search lights with carriers (see Figure 5-26)
	24 personnel (12 M16/M4 and 6 M16/ M4 with M203 6 SAW)	24 riot face shields 24 sets of shin guards 100 sets of disposable flex-cuffs 24 individual voice amplification systems 24 individual RCA dispensers with carriers 6 expandable riot batons with carriers 11 grenade pouches 12 forty-millimeter grenade pouches 6 twelve-gauge ammunition pouches 6 twelve-gauge batonstock ammunition carriers

National Guard in 1992 - Los Angeles (mil photo)

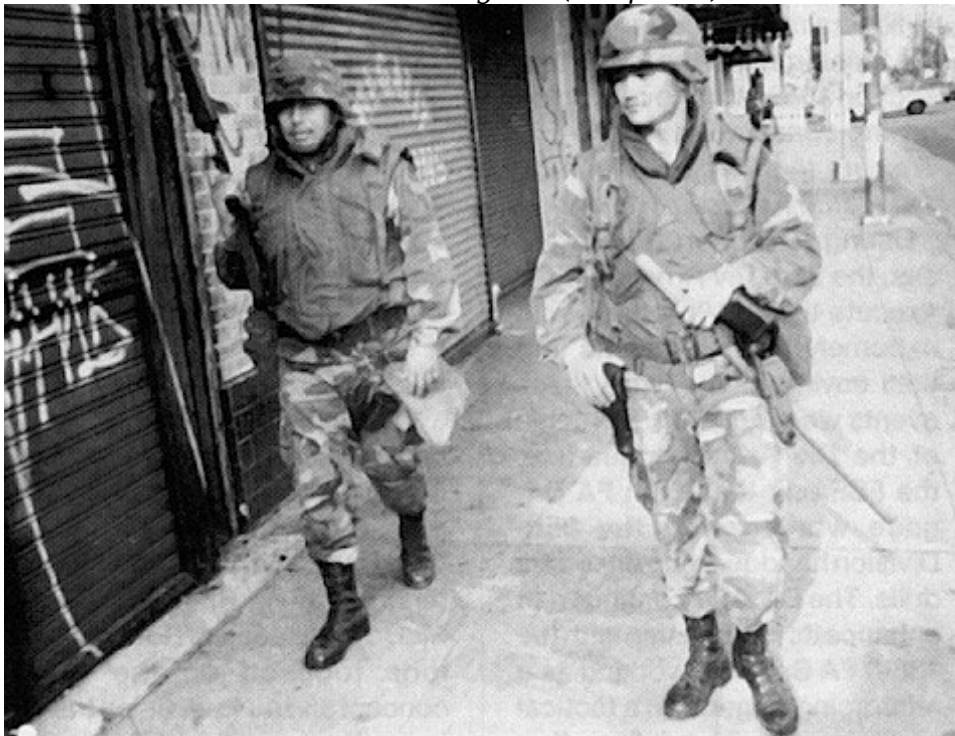

- [Local](#)
- [civil disturbances](#)

- [crowd control](#)
 - [fema](#)
 - [military](#)
 - [Northcom](#)
 - [Pentagon](#)
 - [riot police](#)
 - [RNC Aftermath](#)
 - [Feature](#)
-
- 2849 reads
 - [Printer-friendly version](#)

Comments

Nobody's commented on this

Submitted by Anonymous (not verified) on Sun, 11/21/2010 - 18:43.

Nobody's commented on this yet? That's some fine research there my friend, it would have been worth it for just the tipping point info (real useful to know!), but so much else. Well found, well dug. Thank you.

- [reply](#)

Post new comment

Your name:

E-mail:

The content of this field is kept private and will not be shown publicly.

Homepage:

Subject:

Comment: *

[Switch to plain text editor](#)

- Web page addresses and e-mail addresses turn into links automatically.
- Allowed HTML tags: <a> <p> <div> <h1> <h2> <h3> <h4> <h5> <h6> <map> <area> <hr>

 <dl> <dt> <dd> <table> <tr> <td> <u> <i> <ins> <sub> <sup> <quote> <blockquote> <pre> <address> <code> <cite> <embed> <object> <param> <strike> <caption>

[More information about formatting options](#)

CAPTCHA

This question is for testing whether you are a human visitor and to prevent automated spam submissions. If the question is difficult--do your best. After a wrong answer a new question will appear.

```
  _ _ _ _ _   _ _ _   _ _ _   _ _  
| | | | | _ | | _ | | _ | ( _ )  
| | | | | _ | | _ | | | / _ \  
| _ | | | _ | | _ | | | | ( ) |  
 \_ / | | | _ | | | \_ /
```

Enter the code above: *

Enter the code depicted in ASCII art style.

Global IMC Network

- www.indymedia.org
- africa
 - [Ambazonia](#)
 - [Canarias](#)
 - [estrecho / madiag](#)
 - [Kenya](#)
 - [Nigeria](#)
 - [South Africa](#)
- canada
 - [Hamilton](#)
 - [London, Ontario](#)
 - [Maritimes](#)
 - [Montreal](#)
 - [Ontario](#)
 - [Ottawa](#)

- [Quebec](#)
- [Thunder Bay](#)
- [Vancouver](#)
- [Victoria](#)
- [Windsor](#)
- [Winnipeg](#)
- east asia
 - [burma](#)
 - [Jakarta](#)
 - [Japan](#)
 - [Korea](#)
 - [Manila](#)
 - [QC](#)
 - [Saint-Petersburg](#)
- europe
 - [Abruzzo](#)
 - [Alacant](#)
 - [Andorra](#)
 - [Antwerpen](#)
 - [Armenia](#)
 - [Athens](#)
 - [Austria](#)
 - [Barcelona](#)
 - [Belarus](#)
 - [Belgium](#)
 - [belgrade](#)
 - [Bristol](#)
 - [Brussels](#)
 - [Bulgaria](#)
 - [Calabria](#)
 - [Croatia](#)
 - [Cyprus](#)
 - [emilia-romagna](#)
 - [estrecho / madiag](#)
 - [Euskal Herria](#)
 - [Galiza](#)
 - [Germany](#)
 - [grenoble](#)
 - [Hungary](#)
 - [Ireland](#)
 - [Istanbul](#)
 - [Italy](#)
 - [La Plana](#)
 - [Liege](#)
 - [liguria](#)
 - [Lille](#)
 - [linksunten](#)
 - [lombardia](#)
 - [London](#)
 - [Madrid](#)
 - [Malta](#)
 - [Marseille](#)

- [Nantes](#)
- [Napoli](#)
- [Netherlands](#)
- [Nice](#)
- [Northern England](#)
- [Norway](#)
- [Nottingham IMC](#)
- [Oost-Vlaanderen](#)
- [Paris/Île-de-France](#)
- [Patras](#)
- [Piemonte](#)
- [Poland](#)
- [Portugal](#)
- [Roma](#)
- [Romania](#)
- [Russia](#)
- [Sardegna](#)
- [Scotland](#)
- [Sverige](#)
- [Switzerland](#)
- [Thessaloniki](#)
- [Torun](#)
- [Toscana](#)
- [Toulouse](#)
- [Ukraine](#)
- [United Kingdom](#)
- [Valencia](#)
- latin america
 - [Argentina](#)
 - [Bolivia](#)
 - [Chiapas](#)
 - [Chile](#)
 - [Chile Sur](#)
 - [CMI Brasil](#)
 - [CMI Sucre](#)
 - [Colombia](#)
 - [Ecuador](#)
 - [Mexico](#)
 - [Peru](#)
 - [Puerto Rico](#)
 - [Qollasuyu](#)
 - [Rosario](#)
 - [santiago](#)
 - [Tijuana](#)
 - [Uruguay](#)
 - [Valparaiso](#)
 - [Venezuela](#)
- oceania
 - [Aotearoa](#)
 - [Brisbane](#)
 - [burma](#)
 - [darwin](#)

- [Jakarta](#)
- [Manila](#)
- [Melbourne](#)
- [Perth](#)
- [QC](#)
- [Sydney](#)
- south asia
 - [India](#)
 - [Mumbai](#)
- united states
 - [Arizona](#)
 - [Arkansas](#)
 - [Asheville](#)
 - [Atlanta](#)
 - [Austin](#)
 - [Austin Indymedia](#)
 - [Baltimore](#)
 - [Big Muddy](#)
 - [Binghamton](#)
 - [Boston](#)
 - [Buffalo](#)
 - [Charlottesville](#)
 - [Chicago](#)
 - [Cleveland](#)
 - [Colorado](#)
 - [Columbus](#)
 - [DC](#)
 - [Hawaii](#)
 - [Houston](#)
 - [Hudson Mohawk](#)
 - [Kansas City](#)
 - [LA](#)
 - [Madison](#)
 - [Maine](#)
 - [Miami](#)
 - [Michigan](#)
 - [Milwaukee](#)
 - [Minneapolis/St. Paul](#)
 - [New Hampshire](#)
 - [New Jersey](#)
 - [New Mexico](#)
 - [New Orleans](#)
 - [North Carolina](#)
 - [North Texas](#)
 - [NYC](#)
 - [Oklahoma](#)
 - [Philadelphia](#)
 - [Pittsburgh](#)
 - [Portland](#)
 - [Richmond](#)
 - [Rochester](#)
 - [Rogue Valley](#)

- [Saint Louis](#)
- [San Diego](#)
- [San Francisco](#)
- [San Francisco Bay Area](#)
- [Santa Barbara](#)
- [Santa Cruz, CA](#)
- [Sarasota](#)
- [Seattle](#)
- [Tampa Bay](#)
- [Tennessee](#)
- [Urbana-Champaign](#)
- [Vermont](#)
- [Western Mass](#)
- [Worcester](#)
- west asia
 - [Armenia](#)
 - [Beirut](#)
 - [Israel](#)
 - [Palestine](#)
- process
 - [FBI/Legal Updates](#)
 - [Mailing Lists](#)
 - [Process & IMC Docs](#)
 - [Tech](#)
 - [Volunteer](#)
- projects
 - [Print](#)
 - [Radio](#)
 - [Satellite TV](#)
 - [Video](#)
- regions
 - [United States](#)
- topics
 - [Biotech](#)

Movement Media for Minneapolis-St. Paul