

THE  
**H-EARTH**  
BOOK

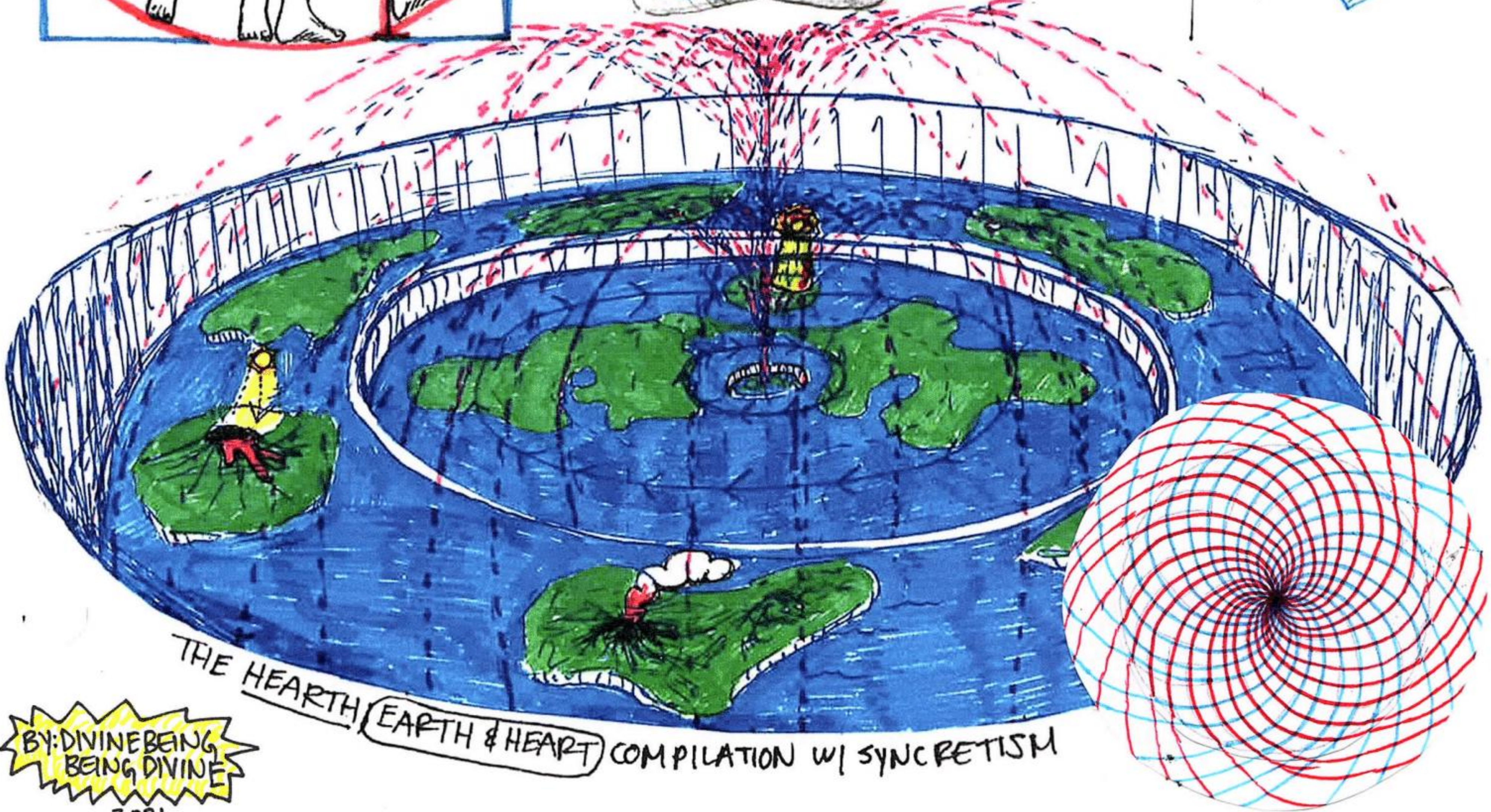

THE HEARTH (EARTH & HEART) COMPILATION W/ SYNCRETISM

BY: DIVINE BEING  
BEING DIVINE  
2021

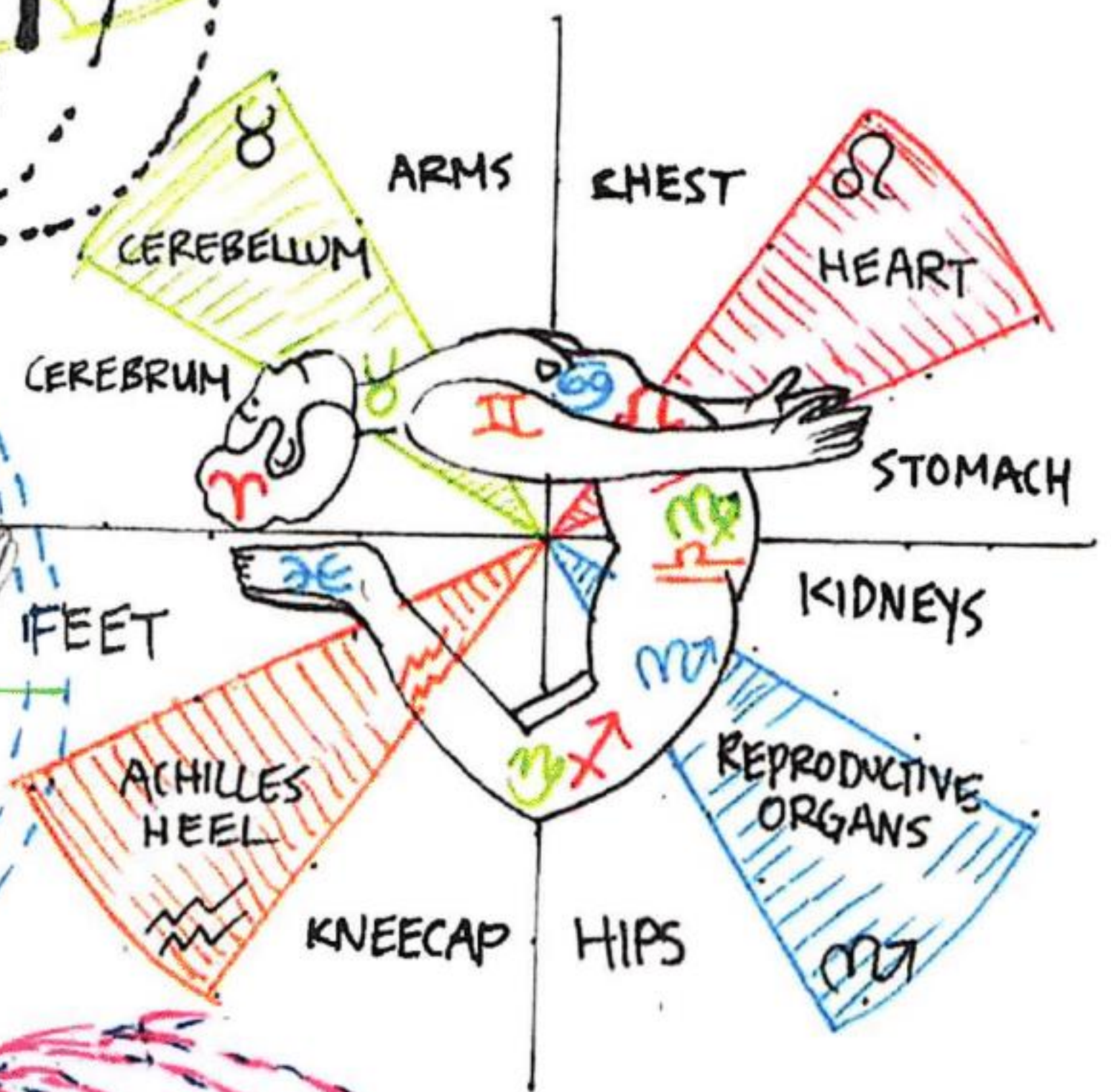
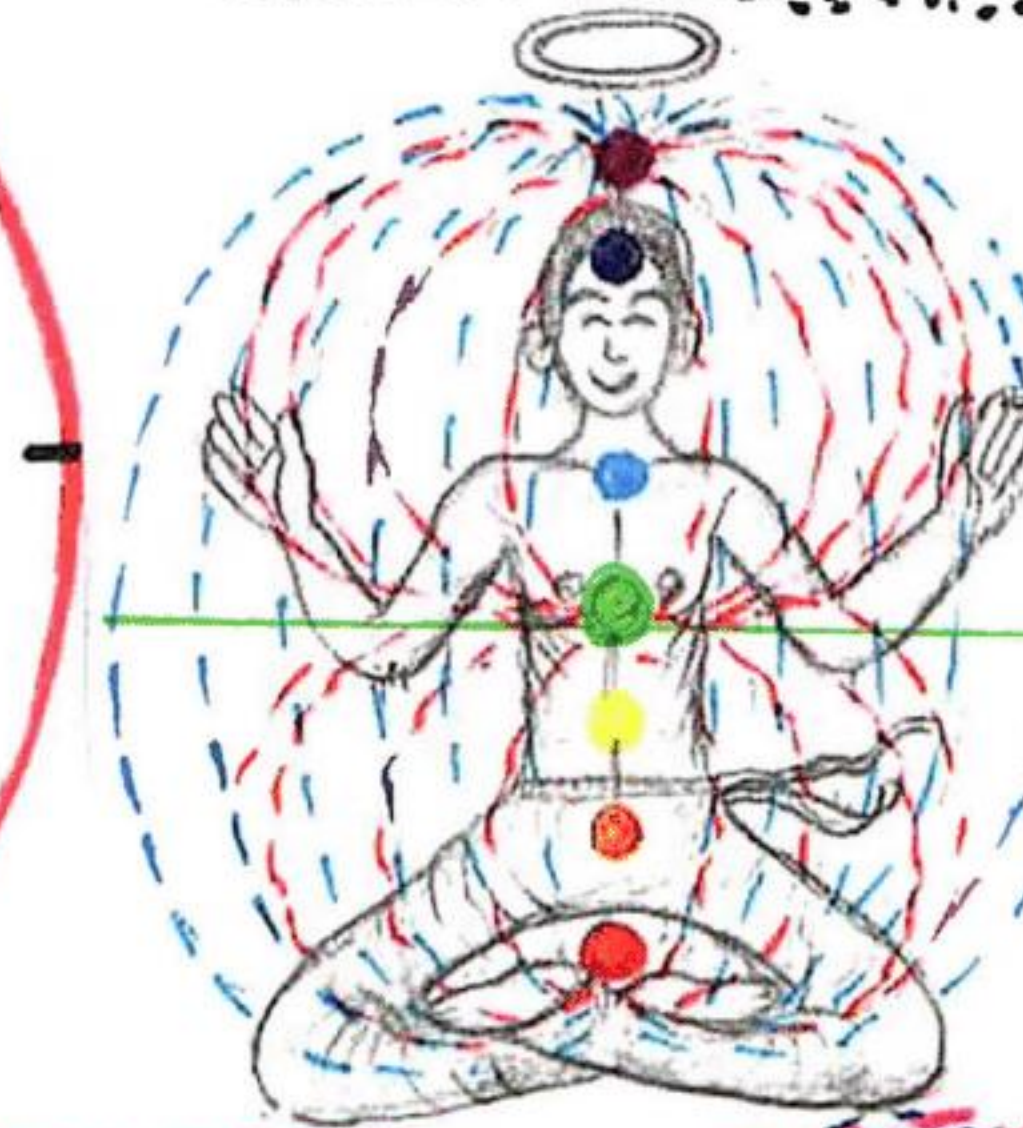
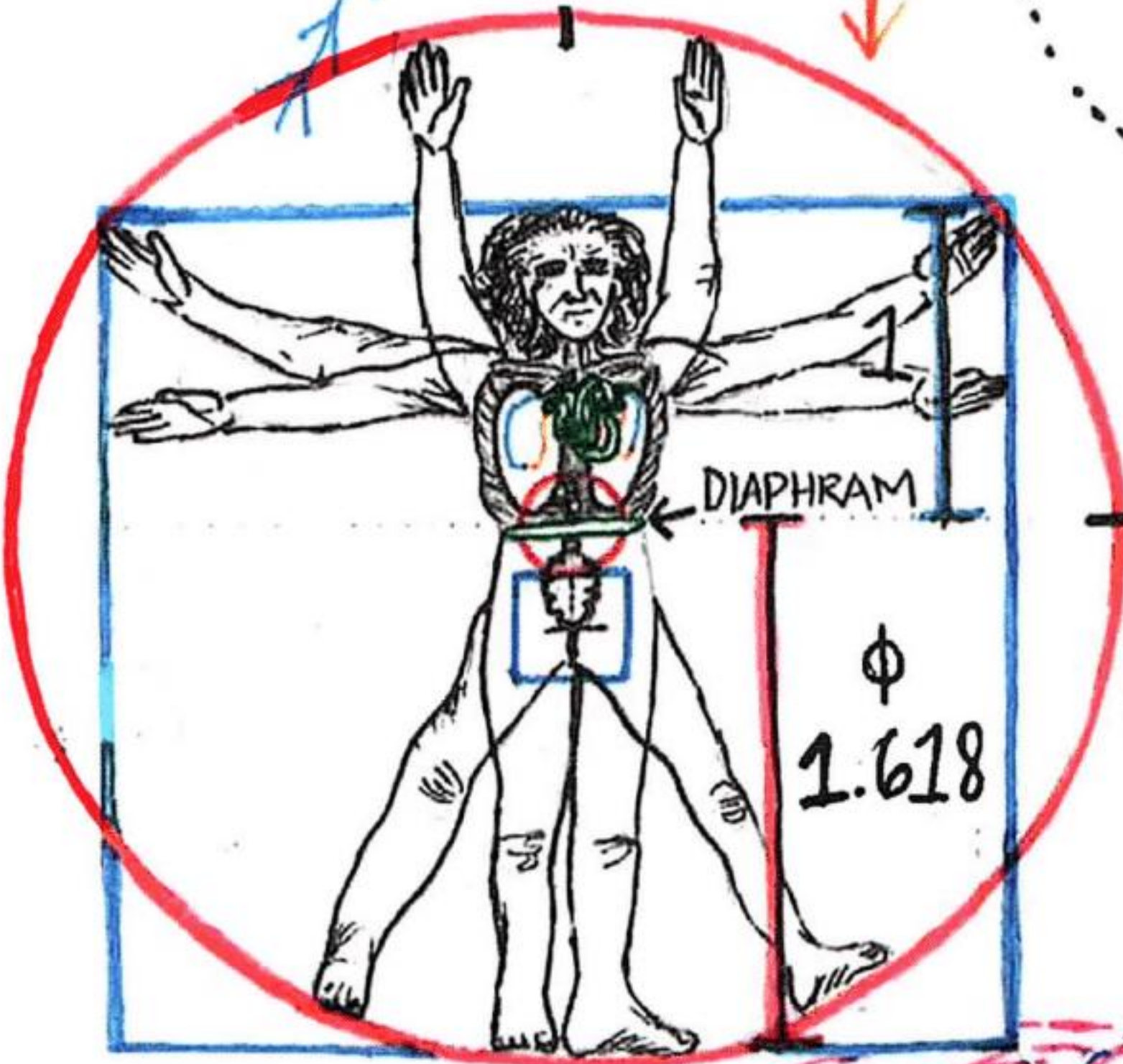

# THE HEARTH BOOK: (EARTH & HEART) COMPILATION W/ SYNCRETISM.

"YOU WILL KNOW THE TORUS AND THE TORUS WILL SET YOU FREE."

TRUTH TORUS

IT IS IMPORTANT TO UNDERSTAND THAT THE INNER-VOLUME OF EVERY ATOM IS **MAGNETO-DIELECTRICITY**, THE 2 SYMBIOTIC FORCES REPRESENTED BY THE YIN & YANG, WHICH IS **MAGNETISM** - THE CREATOR OF SPACE, AND **DIELECTRICITY** - THE ERASER OF SPACE.

THE DIELECTRICITY IN OUR ATOMS SEEKS REST, SILENCE & STILLNESS, WHILE THE MAGNETIC FIELD IS CONSTANTLY IN MOTION, MAINTAINING ITS VOLUME THROUGH DIMENSIONAL FORCE VIA CENTRIFUGAL DIVERGENCE, WHICH IS THE FULL EXTRAPOLATION OF **CENTRIPETAL CONVERGENCE**, THEREFORE MAGNITUDE IS THE POSTERIOR ATTRIBUTE OF A DIVERGING MAGNETIC FIELD.

THE DIELECTRIC FIELD OR "COUNTER-SPACE" IS PURE ENERGY AND POTENTIAL, WHEREAS MAGNETISM IS THE LOSS OF ENERGY & POTENTIAL "PURE IMPOTENCY". ONLY WHEN THESE 2 AETHER FIELD MODALITIES ACT UPON EACH OTHER IS THERE "ELECTRIFICATION/ACTUALIZATION"

"COUNTERSPACE" - IS LIKE A GIANT TOOTHLESS DRAGON, PEACEFULLY SLEEPING IN A PITCH BLACK DUNGEON - NOTHING BUT PURE POTENTIAL YOU COULDN'T DESCRIBE NOTHING ELSE, BUT THE POTENTIAL OF AWAKENING...

"SPACE" - IS MAGNETISM, WHICH TESLA SAID, "HAS NO ATTRIBUTES" - BECAUSE IT IS MASSLESS, WEIGHTLESS PARTICLE LACKING AND INVISIBLE, YET IT RELEASES FORCE & IT CARRIES ELECTRICITY. THUS TESLA CALLED THE HEAVENS ABOVE... "THE LUMINIFEROUS AETHER" BECAUSE HE KNEW THE AETHER FIELD, CARRIED THE LUMENARIES. MAGNETISM IS BOTH "VOLUMINOUS" & "LUMINOUS".

THE TORUS & THE HYPERBOLA MAKE UP THE 'ATOM/3D GEOMETRY OF A MAGNETIC FIELD, WHICH IS THE SIMPLEX CONJUGATE GEOMETRY OF THE UNIVERSE.

A SINK & BUBBLE... THE TOROIDAL BUBBLE RADIATES OUT FROM THE CENTER UP AND AROUND CREATING A DONUT SHAPE AS IT RETURNS BACK TO THE CENTER. THE HYPERBOLOID IS A DOUBLE SINK, HOUR-GLASS SHAPE THAT SITS PERFECTLY INSIDE A DONUT.

-KEN WHEELER SAID THAT A BLACK HOLE IS WHEN THE DIELECTRIC FIELD OVERTHROWS MAGNETISM'S ABILITY TO KEEP THINGS HERE IN THE VISIBLE UNIVERSE, OUR REALITY, BECAUSE 100% OF EVERYTHING IN THE UNIVERSE WITH MASS & MAGNITUDE IS DUE TO MAGNETISM & MAGNETISM ONLY, THE TOROIDAL DYNAMICS ITSELF IS WHAT GENERATES ALL BALANCE, MOVEMENT & LIFE IN THE UNIVERSE, AS WELL AS BEAUTY - WHICH IS THE MULTIPLICATIVE MANIFESTATION OF THE EXTRINSIC ATTRIBUTE OF THE ONE - WHICH IS UNMANIFEST. ANYTHING PHYSICAL IS AN EMERGENT PROPERTY, AND ALL PHYSICALITY IS SUSTAINED BY MOTION (THE WORD "MAG" MEANS TO MOVE IN SANSKRIT. (MAGNETISM))

IN REVELATION 12 "THERE WAS ENORMOUS RED DRAGON WITH 7 HEADS, 10 HORNS AND 7 CROWNS ON ITS HEADS... - THE DRAGON STOOD IN FRONT OF THE WOMAN WHO WAS ABOUT TO GIVE BIRTH, SO THAT IT MIGHT DEVOUR HER CHILD THE MOMENT HE WAS BORN...!"

-KEN WHEELER DESCRIBES A BLACK HOLE AS A MASS WITH NO MAGNITUDE, OR A SINK WITH NO BUBBLE... A SHOWER HEAD SHOOTING OR POURING WATER DIRECTLY INTO THE DRAIN OR A SINK, WITH NO AREA FOR THE WATER TO FLOW.

IN GREEK MYTHOLOGY, KRONOS "FATHER-TIME" WHOSE SYMBOL IS THE HOURGLASS/HYPERBOLA, DEVOURS HIS CHILDREN THE MOMENT THEY ARE BORN TO PREVENT FROM BEING OVERTHROWN AS HE OVERTHREW HIS FATHER, UNTIL RHEA INTERVENES.

REV 12:16 "THE EARTH HEARD THE WOMAN, THE EARTH OPENED ITS MOUTH AND SWALLOWED UP THE RIVER WHICH THE DRAGON SPEWED OUT OF HIS MOUTH." MAGNETISM - PROVIDES THE SPACE, MAGNITUDE [AREA] & RANGE NECESSARY FOR DEVELOPMENT - COUNTERSPACE MANIFESTS AS SPACE... ITS THE INFORMATION THAT UNDERLIES ALL FORMS.

WE ARE FRACTALS OF INFINITE CONSCIOUSNESS! THE HUMAN BODY - IS JUST THE AVATAR GOD USES WHEN DREAMING UP THIS REALITY... GOD IS MAN ASLEEP... MAN IS GOD AWAKE!

MARY HOLDS HER SON JESUS - MARY MAGNETISM - FATHER RHEA HOLDS ZEUS - LIGHTNING.



- SYNCRETISM ENABLES YOU TO ACTIVATE THE GOD MIND (ESOTERIC KNOWING) AND NOT (EXOTERIC BELIEF).

- SOMETIMES IT HAPPENS IN REVERSE, BUT USUALLY AWAKENING, HAPPENS THROUGH KNOWLEDGE, THE OTHER WAY AROUND.



MARTIN KENNY

THE ASCENSION PROCESS HAS BEGUN... THE SHIFT IS HAPPENING!



BRO SANCHEZ

THERE IS NO SOUTH POLE, IT DOESN'T EXIST, NOR DOES GRAVITY!



KEN WHEELER

MAGNETISM IS THE DIELECTRIC FIELD!



SANTOS BONACCI

YOU MUST RAISE THE CHRISM TO AWAKEN YOUR THIRD EYE!

PART OF OUR MISSION ON EARTH IS TO MASTER OUR THOUGHTS, VIBRATIONS & FREQUENCY SO THAT CAN MOVE THROUGH ALL OF LIFE WITH EASE

RIGHT NOW ALL HUMANS ARE CAPABLE OF LYING, FREE WILL AS CONSCIOUSNESS RISES IN THE COLLECTIVE SO WILL OUR TELEPATHIC ABILITIES; AS OUR SOUL ENERGIES ASCEND TO HIGHER LEVELS AND REALMS OF LOVE AND ENLIGHTENMENT, LYING WILL NO LONGER EXIST.

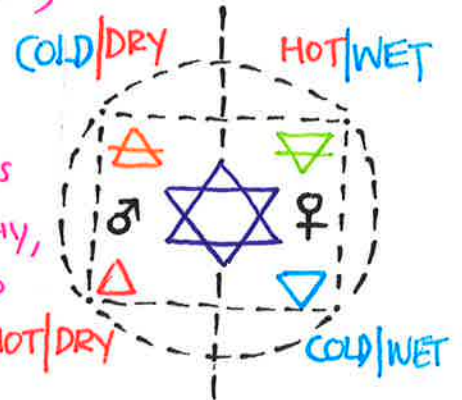

CONSISTENT MEDITATION & YOGA COMBINED OVERTIME CAN ENABLE HUMANS TO ACCESS SUPER NATURAL POWERS SUCH AS TELEPATHY, LEVITATION, TELEPORTATION, TELEKINESIS REMOTE VIEWING & MORE. - THESE ABILITIES ARE PURPOSELY HIDDEN TO KEEP US FROM REACHING OUR FULL POTENTIAL.

THEIR PUTTING THEIR ELECTRIC GRID OVER THE NATURAL ORGANIC WORLD

MAGNETISM IS FREE, AND HEALING... ELECTRICITY COSTS, AND HURTS/HERTZ

THE TIBETAN BOOK OF THE DEAD: COMING FROM FROM DARKNESS TO LIGHT.

- GAINING HEIGHT OR TOWARDS THE LIGHT.

THE DEAD SEA SCROLLS

- THE SONS OF LIGHT VS. THE SONS OF DARKNESS.

OSIRIS LORD OF THE ABDJU/ABYDOS, EGYPT 'OSIRIOPOLIS TEMPLE'

ENKI LORD OF THE ABZU/APSU

PLANT SEEDS AS THE MOON WAXES AND GROWS.

STRUCTURED OR LIVING WATER IS SELECTIVE ANTIOXIDANT WHICH IS SMART HYDROGEN THAT HAS A MIND OF ITS OWN BECAUSE IT RELIEVES OXIDATIVE STRESS; IT KNOWS WHICH CELLS TO HYDRATE, IT DOESN'T GO DOWN WHEN WE DRINK IT, IT SPREADS THROUGHOUT THE ENTIRE BODY.

IN THEIR PRIMORDIAL STATE, ANIMALS COMMUNICATE USING TELEPATHY, HUMANS LIE USING WORDS AND LANGUAGES.

SPRING WATER + KEY LIMES = ALKALINE (NATURAL)

PURIFIED WATER + BAKING SODA = ALKALINE (ARTIFICIAL)

NATURAL FRUITS AND VEGETABLES = HIGH P.H. + STRUCTURED WATER  
HOLY HYDROGEN MACHINE; DISTILLED, ELECTROLIZED = LIVING WATER

\*WE NEED A CERTAIN LEVEL OF OXIDIZATION TO STAY ALIVE, - WITH STRUCTURED OR LIVING WATER; HIGH BLOOD PRESSURE GOES DOWN, BLOOD CLOTS AND CLOGGED ARTERIES ARE REDUCED, CHOLESTEROL & DIABETES ARE REDUCED.



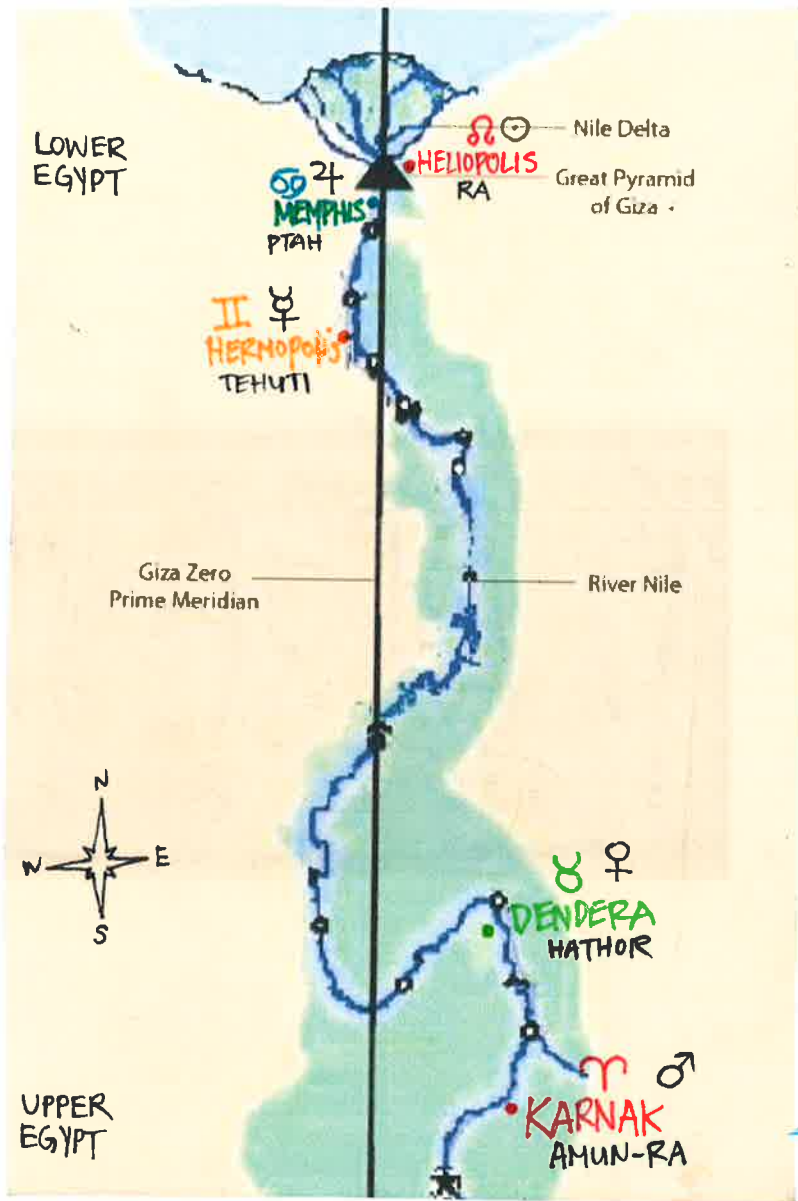

Lower Egypt  $\Omega$   
 From LEO the Heart  
 To ARIES the Crown  
 Upper Egypt  $\Upsilon$

- HELIOPOLIS  $\Omega$  SUN, RA
- MEMPHIS  $\♃$  JUPITER, PTAH
- HERMOPOLIS II MERCURY, HERMES
- DENDERA  $\♀$  VENUS, HATHOR
- KARNAK  $\♂$  MARS, RAMS

THE FLOW OF THE NILE RIVER  
 FLOWS SOUTH TO NORTH.

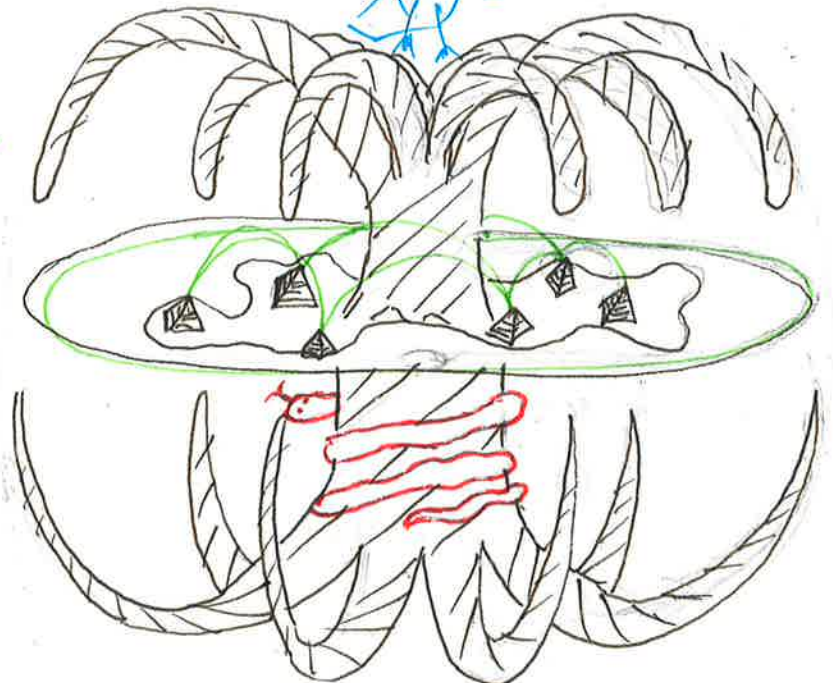
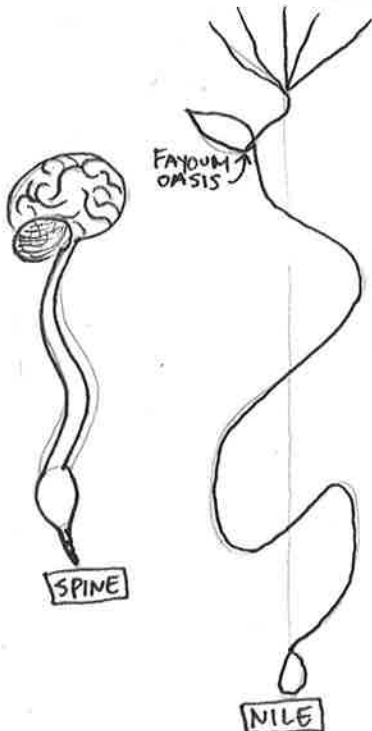



TEHUTI - THOTH - HERMES - MERCURY

LIGHT MERCURY. SPIRIT CADUCEUS. BODY BALANCE  
MER CA BA

THE WORD FOR WISE IS MAGUS - WHICH BECAME MAGICIAN/MAGIC. - TEHUTI (THOTH) IS THE OLDEST KNOWN MAGICIAN, DOCTOR, HEALER. CADUCEUS - MODERN DAY HOSPITAL SYMBOL.

Rx RX = REKET

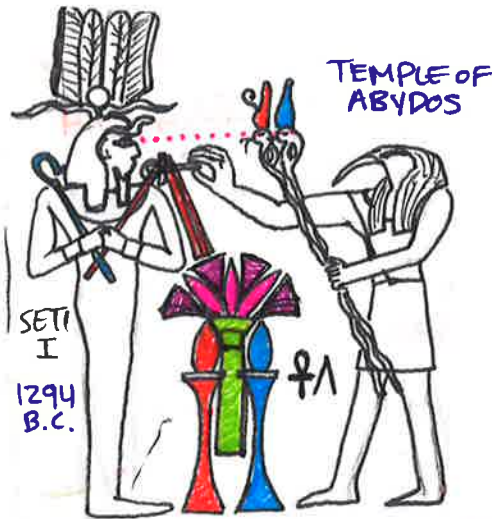

GENESIS 3:1 "NOW THE SERPENT WAS MORE SUBTILE THAN ANY BEAST OF THE FIELD THAT THE LORD GOD HAD MADE."

NUMBERS 21:8 "THE LORD SAID TO MOSES MAKE A BRONZE SERPENT AND PUT IT UP ON A POLE, ANYONE WHO WAS BITTEN BY A SERPENT CAN LOOK UP AT IT AND LIVE."

NUMBERS 21:9 "AND MOSES MADE A SERPENT OF BRASS AND PUT IT ON A POLE AND IT WAS SO, IF A SERPENT HAD BITTEN ANYONE, WHEN HE LOOKED AT THE BRONZE SERPENT HE LIVED."

MATTHEW 10:16 "BEHOLD, I SEND YOU FORTH AS SHEEP IN THE MIDST OF WOLVES, BE YE WISE AS SERPENTS AND AS INNOCENT AS DOVES."

JOHN 3:14 "JUST AS MOSES LIFTED UP THE SERPENT IN THE WILDERNESS, EVEN SO MUST THE SON OF MAN BE LIFTED UP, THAT WHOEVER BELIEVES IN HIM SHOULD NOT PERISH BUT HAVE ETERNAL LIFE."

IN THE GREEK PHILOSOPHY, MERCURY SERPENTS = FIGHTING SNAKES WITH HIS WARD.

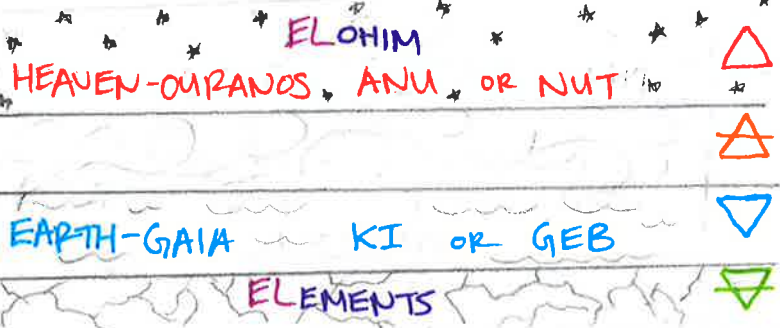
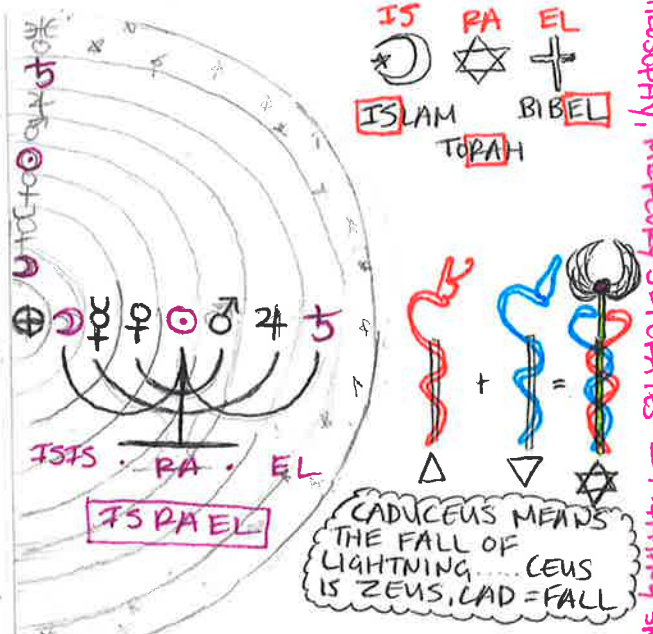
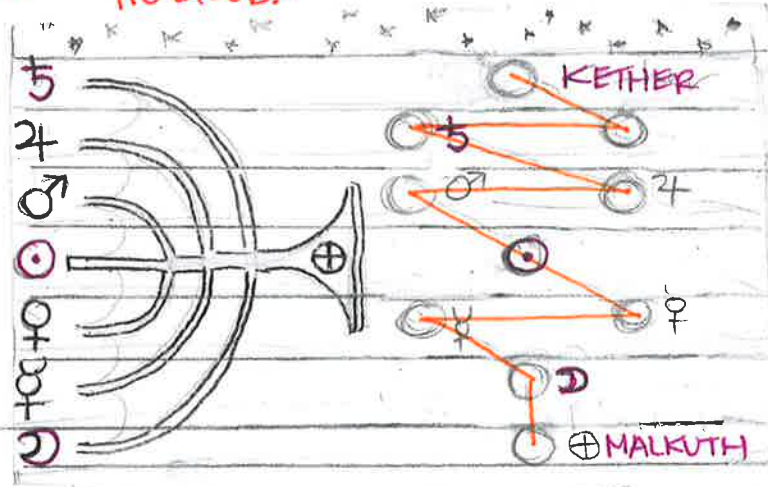
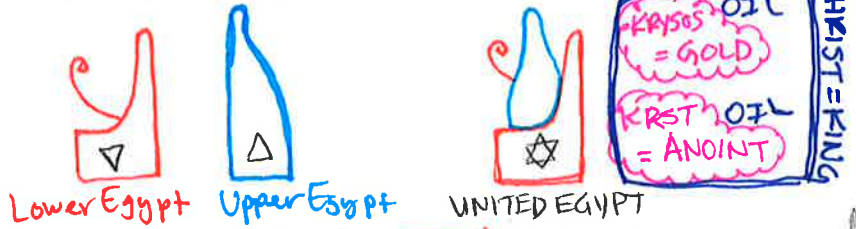

ECCLESIASTES 12:7 "THEN SHALL THE DUST RETURN TO EARTH AS IT WAS AND THE SPIRIT SHALL RETURN TO GOD WHO GAVE IT."

ALL PHYSICALITY IS SUSTAINED BY MOTION..... GOD IS 'HE' WHO CAUSETH FORM. MAGNETISM.

INVENTED THE GUQIN. FUXI. THOTH & SESHAT TAUGHT WRITING. INVENTED WRITING. MEASURING. EXACTLY SIMILAR TO FUXI & NUWA CHINA.



**THE SERAPHIM**

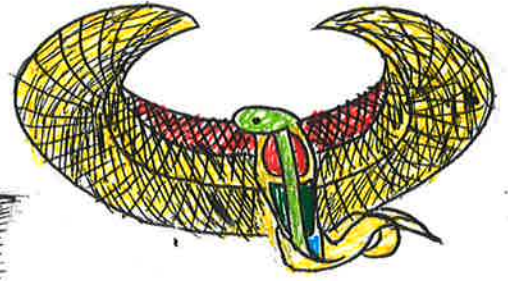

NUMBERS 21:6  
NUMBERS 21:8  
NUMBERS 21:9

(GOD SENDS SERPENTS TO TORTURE THE ISRAELITES AND HE COMMANDS MOSES TO MAKE THEIR SALVATION IN THE IMAGE OF THEIR SUFFERING.) THE CAUSE AND CURE COME FROM THE SAME SOURCE.

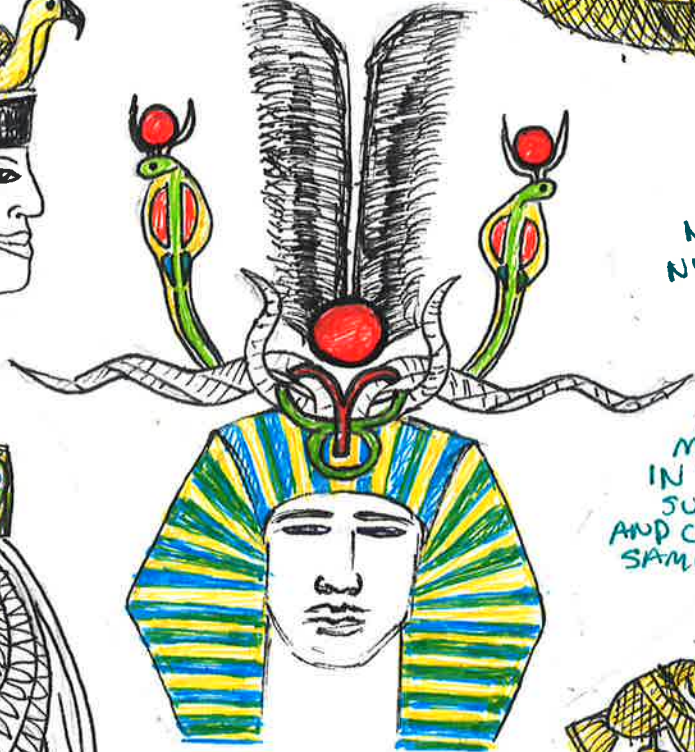

IF GOD IS ALL THEN WHAT FORM COULD EACH THINK TAKE OTHER THEN THE IMAGE OF GOD? THE PROCESS OF CREATION THEN MUST BEGIN WITH A GREAT INTERNAL BREAK WHEREBY GOD DIFFERENTIATES HIMSELF FROM HIMSELF HEAVEN FROM EARTH LIGHT FROM DARKNESS, THE WATERS FROM THE WATERS.

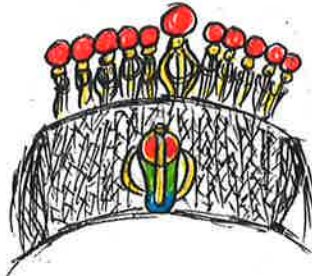

JESUS BEING ANNOINTED AKA CHRISTENED.

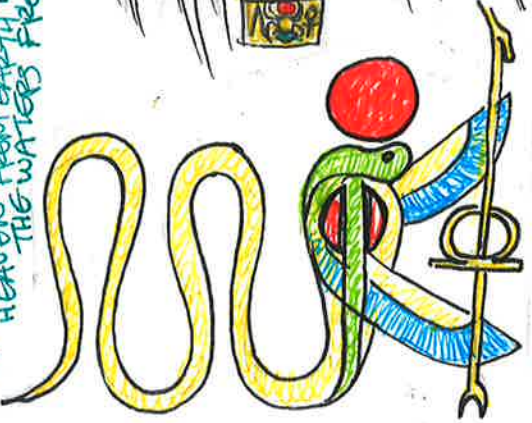

LIBRA ARIES

WINNOWER FLAIL FOR THRESHING WHEAT

SHEPHERD'S CROOK FOR HERDING SHEEP

"And as Moses lifted up the serpent in the wilderness so must the Son of Man be lifted up."

EXODUS 34:29 "HIS FACE WAS RADIANT."

KEREN = HORNS  
KARAN = RADIANT  
KRN = CROWN } CORONA

ADAM'S NAME LINKS HIS NATURE TO EARTH ITSELF.  
ADAMAH = EARTH ADAMINI = RED DAMERBLOOD

(The Serpents Journey from the Lowest of the Low to the Highest of the High)



HELENA PETROVNA BLAVATSKY: THE SECRET DOCTRINE

FOR LUCIFER - IS THE LOGOS IN HIS HIGHEST AND THE ADVERSARY IN HIS LOWEST ASPECT. BOTH OF WHICH ARE REFLECTED IN OUR EGO.

LUCIFER - THE SPIRIT OF THE INTELLECTUAL ENLIGHTENMENT, AND FREEDOM OF THOUGHT, - IS METAPHORICALLY THE GUIDING BEACON WHICH HELPS MAN TO FIND HIS WAY THROUGH THE ROCKS AND SANDBANKS OF LIFE.

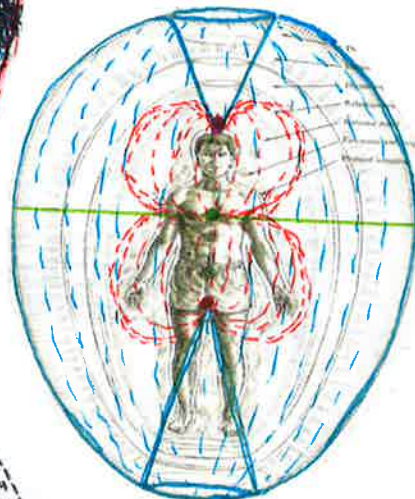
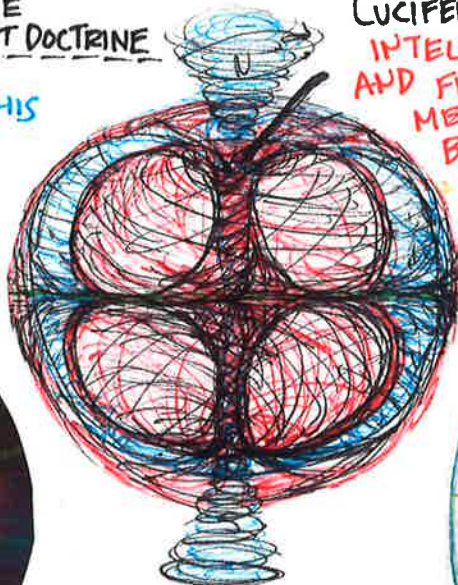
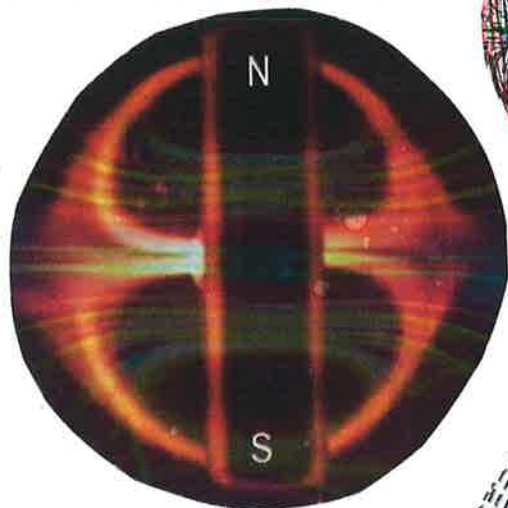

ISAIAH 41:12 HOW ART THOU CUT DOWN TO THE GROUND WHICH DID WEAR EN THE NATIONS.

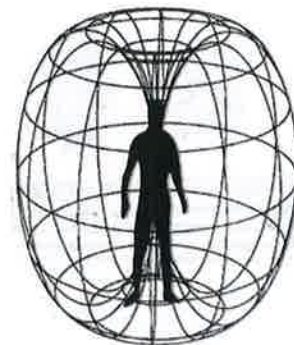
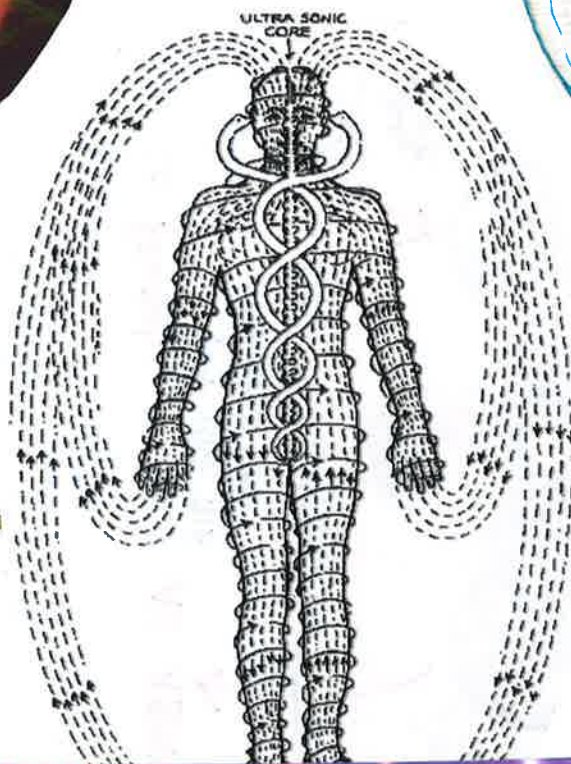
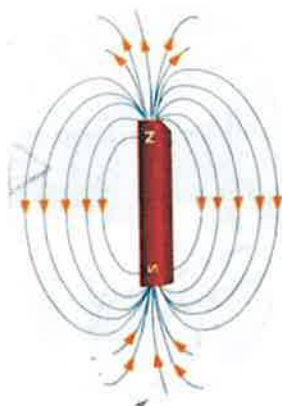

EVERY MONTH WHEN THE MOON ENTERS/ TRANSITS YOUR SUN SIGN THERE IS A PSYCHO-PHYSICAL GERM OR A SEED BORN IN THE SOLAR PLEXUS. 27 AUG 21



EPHESIANS 5:14 AWAKE SLEEPER AND ARISE FROM THE DEAD & CHRIST WILL SHINE ON YOU.

MAN = MIND } MANTRA  
TRA = FREE }

WE CAN EAT FROM THE TREE OF LIFE BUT WE BLEW IT, WE ATE FROM THE TREE OF KNOWLEDGE OF GOOD AND EVIL, OUR LOWER MIND TOOK OVER AND WE MATERIALIZED, TO FEED OUR PHYSICAL BODIES. WE MANIFESTED AS MAN, WHEN WE ATE MANSANAS.



Sun	Gold	☉
Mon	Silver	☾
Tue	Iron	♁
Wed	Mercury	☿
Thu	Tin	♃
Fri	Copper	♁
Sat	Lead	♄

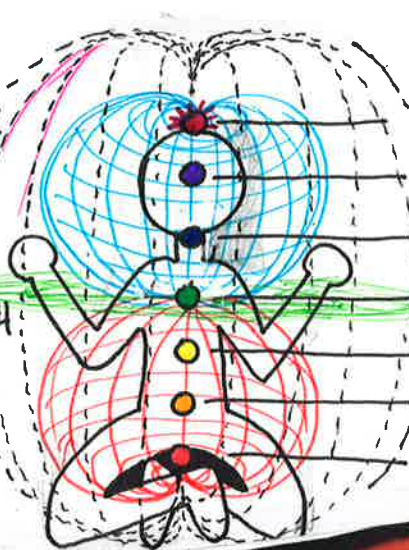
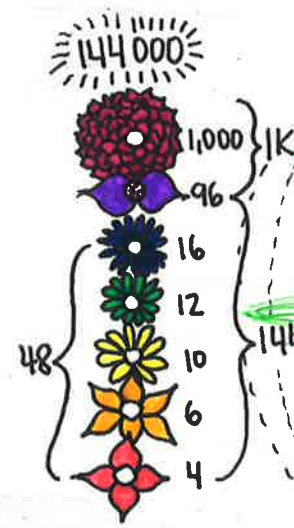

Crown  
Third Eye  
Throat  
Heart  
Solar  
Sacral  
Root

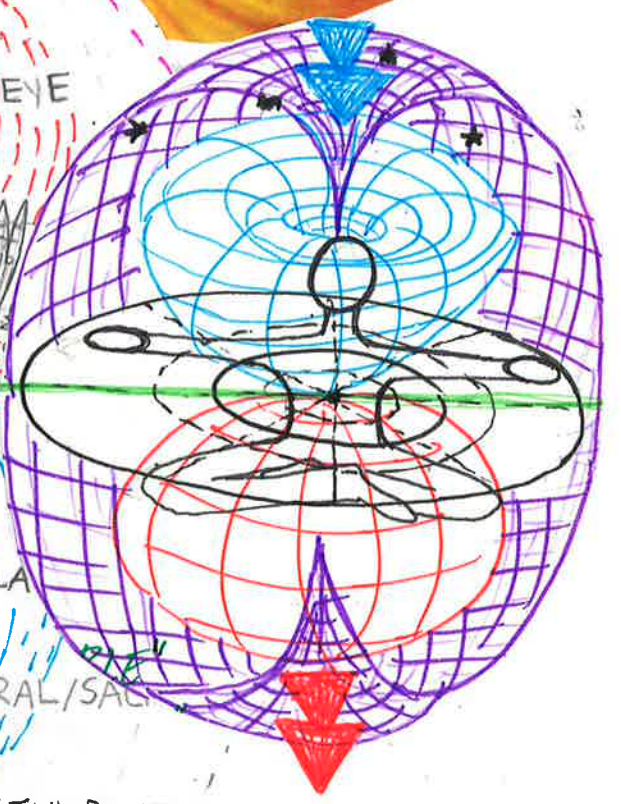
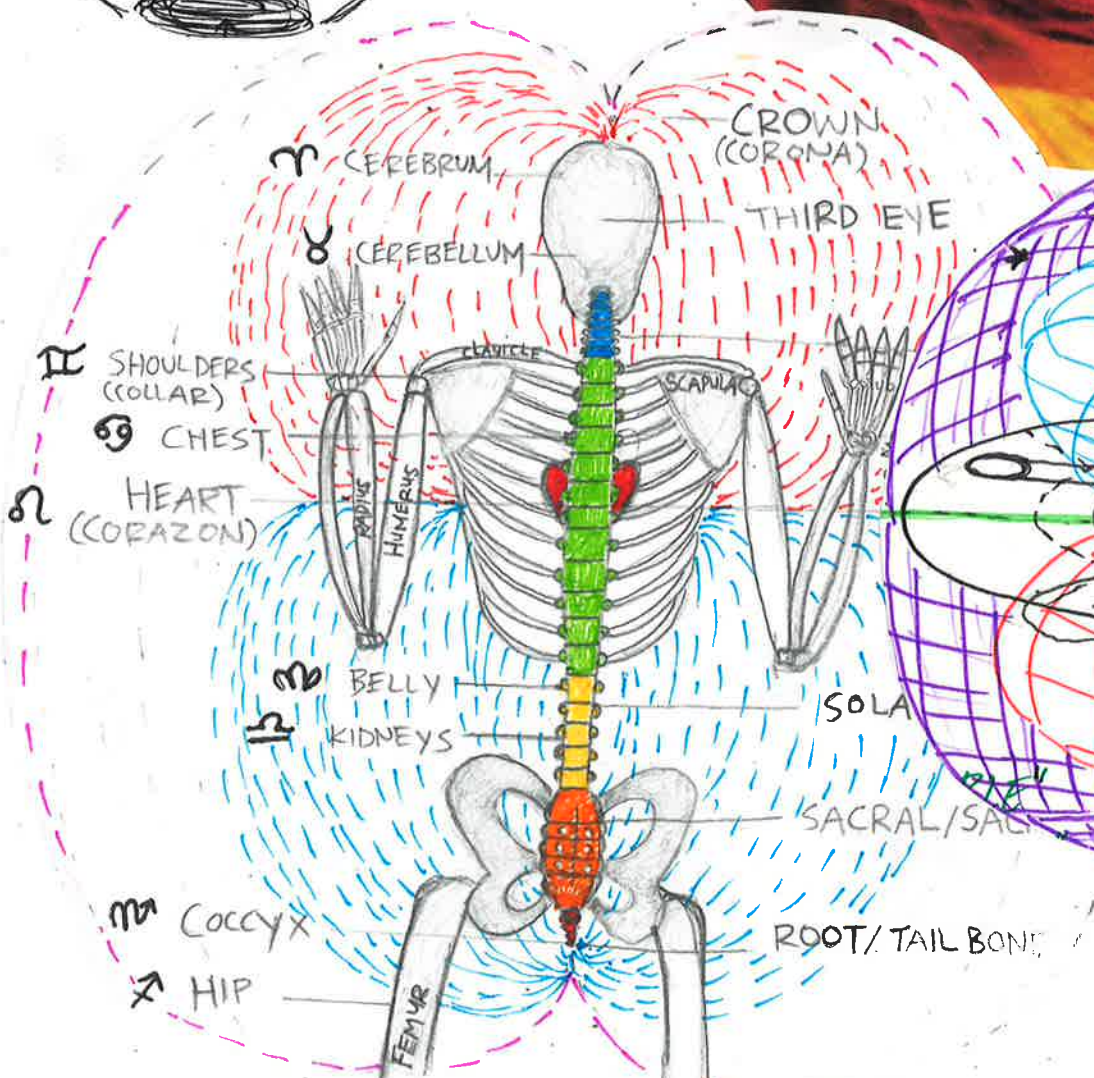
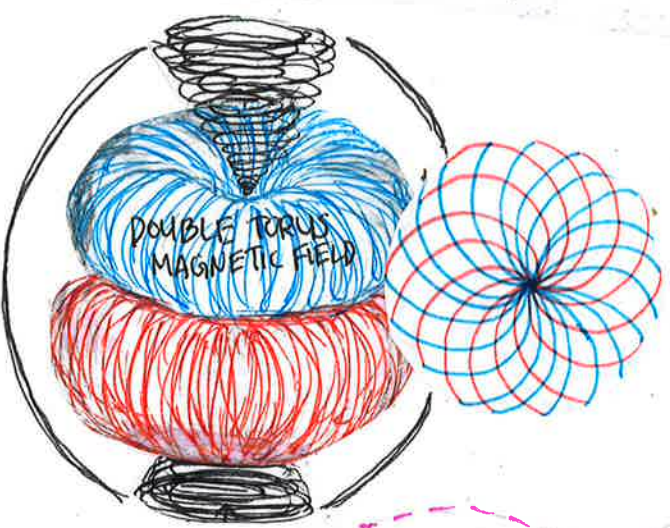



KEN WHEELER.  
 "EVERYTHING IS FIELDS, PRESSURE MEDIATION"

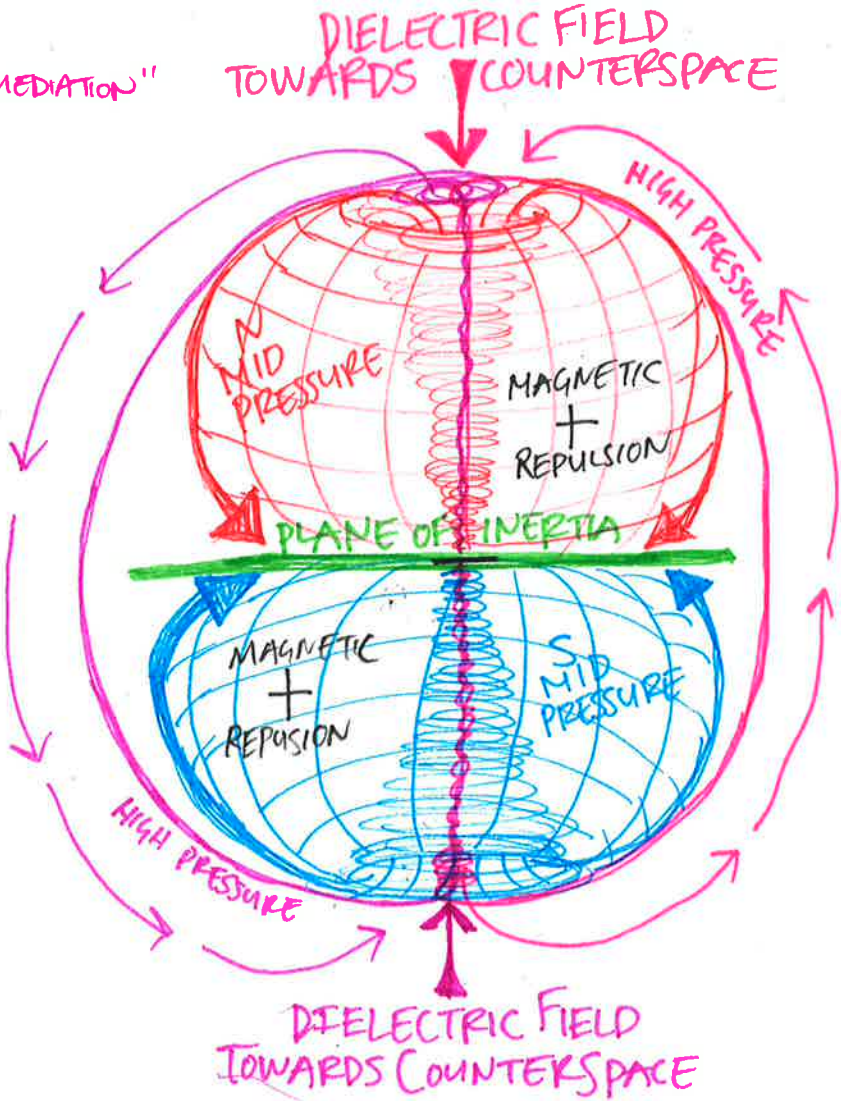
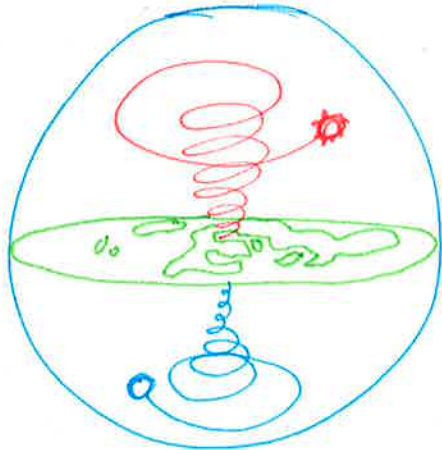
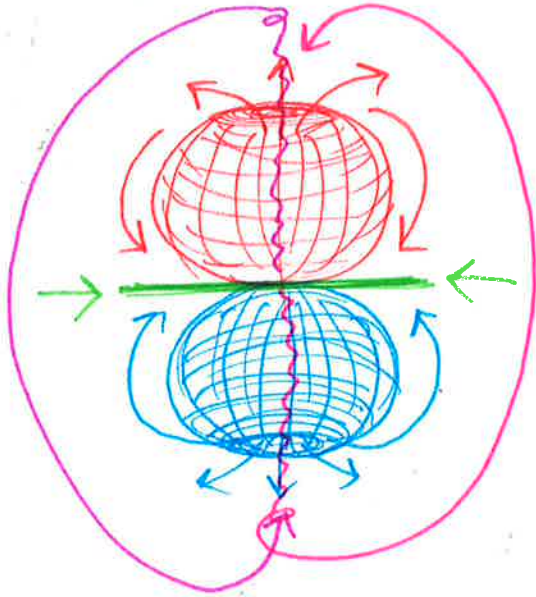

DIELECTRIC FIELD TOWARDS COUNTERSPACE  
 AETHER - PURE CONSCIOUS LOVE & LIGHT

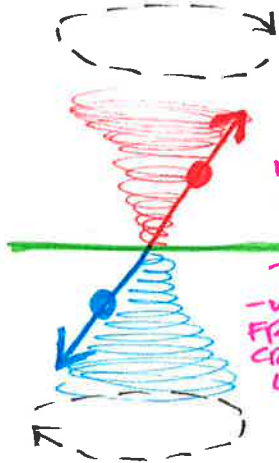

THE COAXIAL CIRCUIT OF MAGNETISM CREATES ALL DIMENSION IN THE UNIVERSE. ANYTHING THAT TAKES UP SPACE. - WHEN VIEWED FROM ABOVE CREATES THE LOTUS OF LIFE.

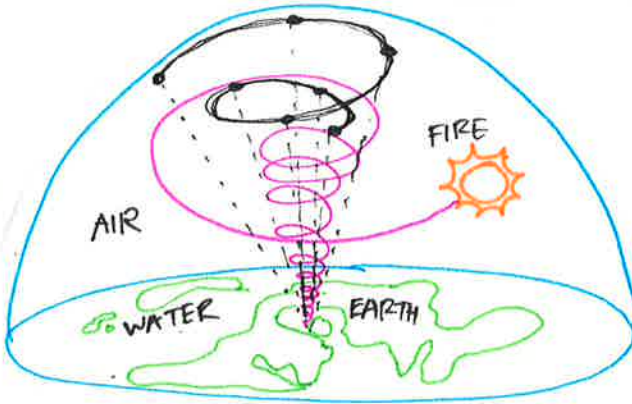

THE SUN IS A FOCAL POINT, AND ITS NOT FLOATING BY ITSELF. ELECTRICITY IS CARRIED BY MAGNETISM.



INNER VOLUME OF EVERY ATOM IS MAGNETO-DIELECTRICITY

MAGNETISM - CREATOR OF SPACE  
 DIELECTRICITY - ERASER OF SPACE  
 "CONSTRUCTIVE & DESTRUCTIVE INTERFERENCE"



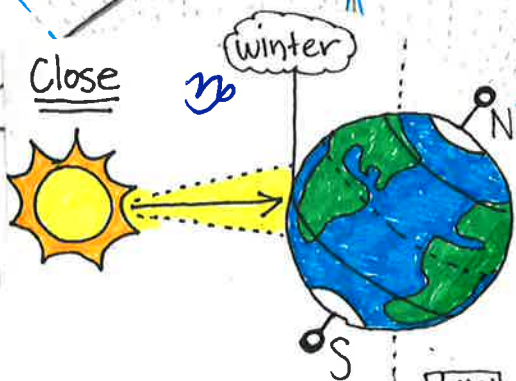
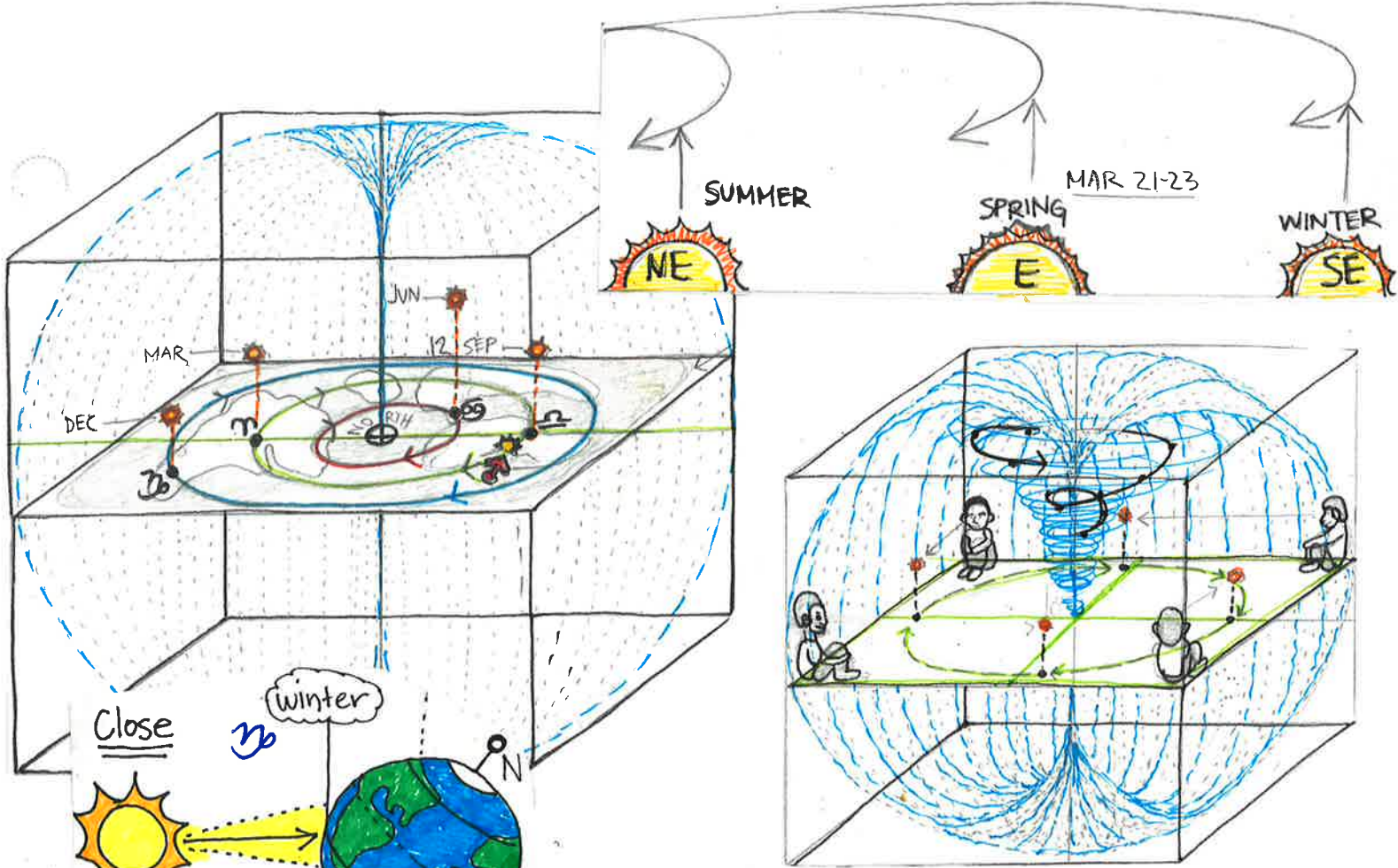

BELOW THE EQUATOR

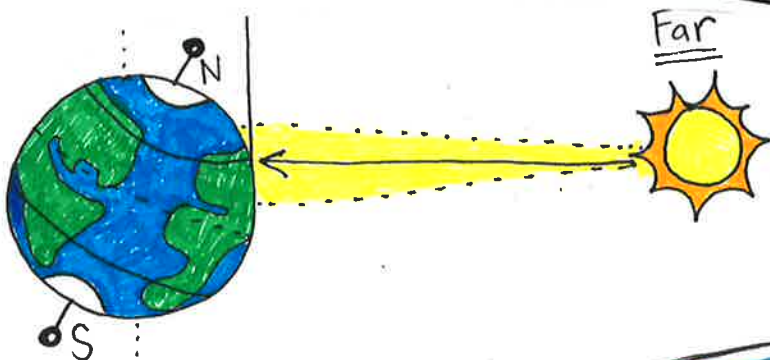
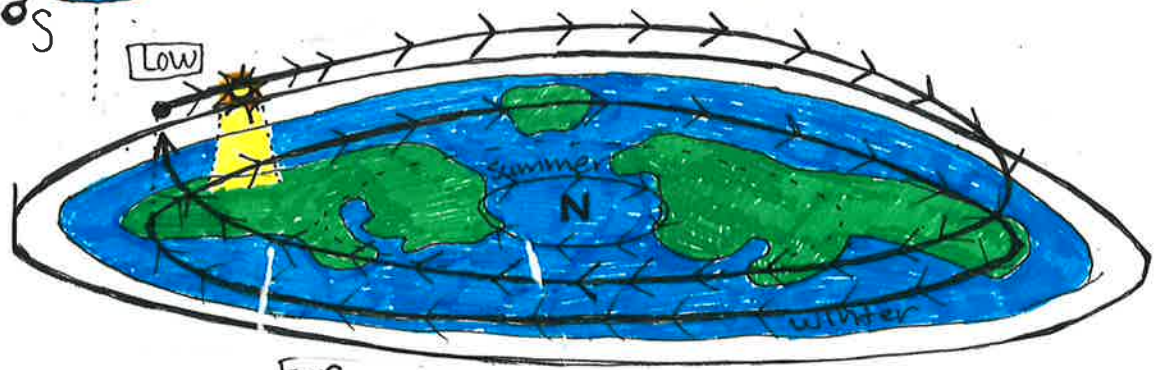

High  
Sun Travels Slower ABOVE THE EQUATOR

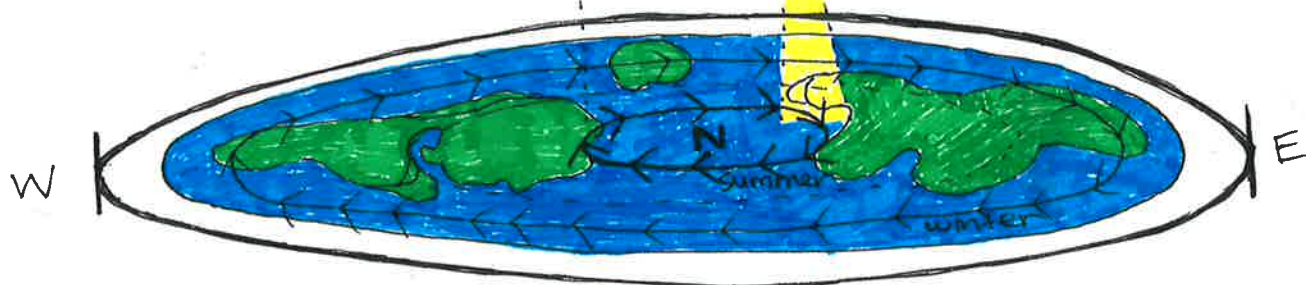



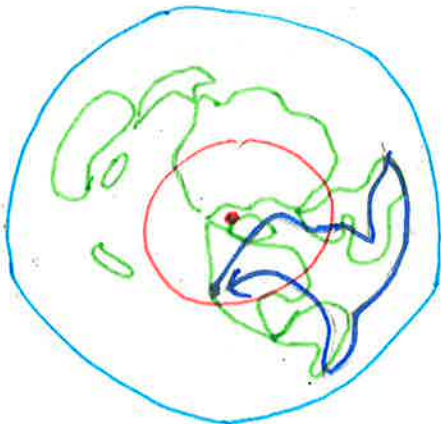

1965  
**BOEING**  
 62 HRS  
 North to South

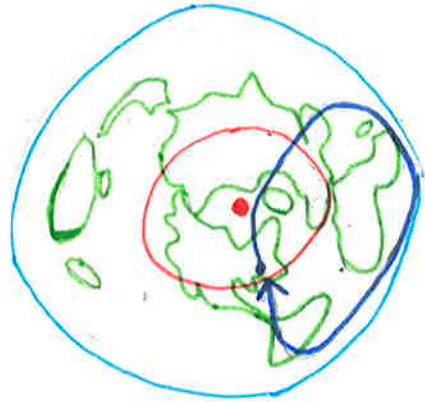

1968  
**CONVAIR**  
 990  
 46 Hrs 39 min.  
 North to South

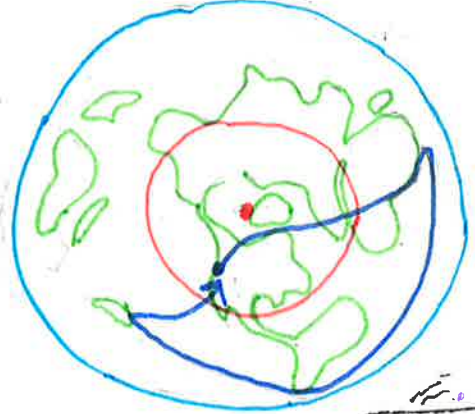

OCTOBER 1977  
 Flight 50 Pan American  
 World Airways  
**BOEING**  
 747  
 North to South  
 54 Hrs 7 min.

PRIMUM MOBILE = FIRST MOTION  
**PRIMUM MOBILE**

- (HADES) 248 YRS ♀ 11-31 YEARS
- (POSEIDON) 168 YRS ♀ 14 YEARS
- (OURANOS) 84 YRS ♂ 7 YEARS
- (PRONOS) 28-30 YRS ♂ 2.5 YEARS
- (ZEUS) 12 YRS ♀ 1 YEAR
- (ARES) 720 ♂ 2 MONTHS
- (APOLLO) 365 ♂ 30 DAYS
- (AFRODITE) 225 ♀ 30 DAYS
- 88 ♀ 25 DAYS
- (ERMES) 28-30 ♂ 2-3 DAYS
- (ARTEMIS)

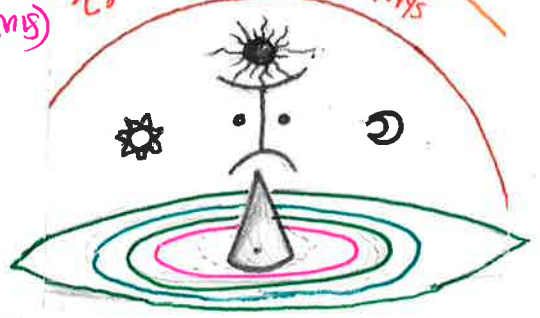

ASTROLOGER - ONE WHO STUDIES THE STARS AND THE HEAVENS.

ASTRONAUT (ASTRO-NOT)  
 ~ACTORNAUT~

**ALIEN = NEIL A.**

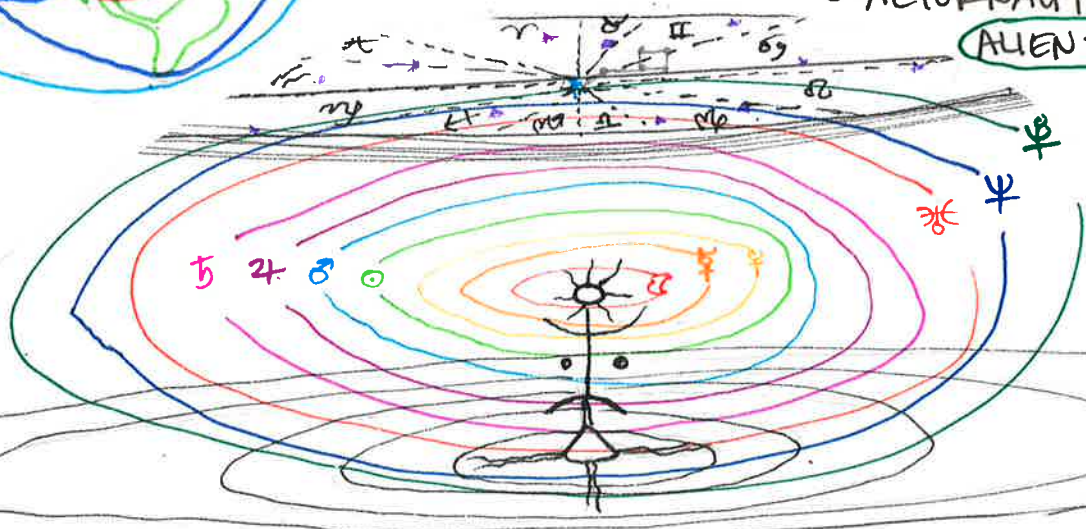

(THE QUADRIVIAN) - A GROUP OF STUDIES CONSISTING OF ARITHMETIC, MUSIC, GEOMETRY, AND ASTROLOGY.

(ASTROLOGOS) - THE BELIEF THAT THE POSITIONING OF THE STARS AND PLANETS AFFECT THE HUMAN CONSCIOUSNESS, THUS THE WAY EVENTS OCCUR ON EARTH.



THE STARS ARE FIXED TO THE VAULT BETWEEN THE EARTH AND THE PRIMORDIAL WATERS. THE STARS NEVER PARALAX, THE EARTH IS STATIONARY.



STARS ROTATE COUNTER-CLOCKWISE East to West

THE 10 LUMINARIES ARE ACTUALLY MOVING THE OPPOSITE DIRECTION. AC RETROGRADE

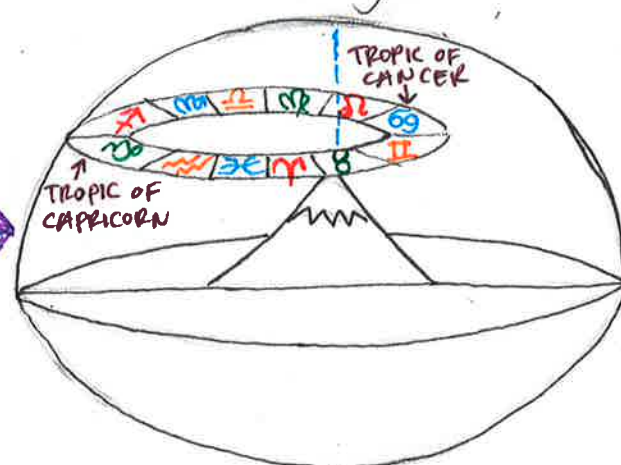
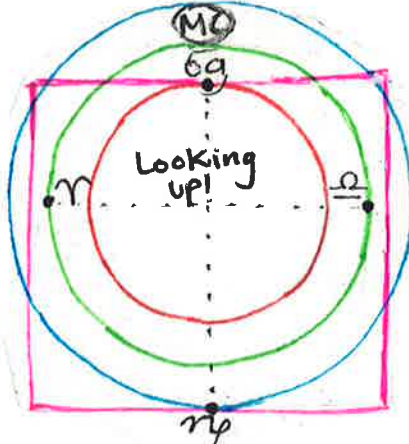
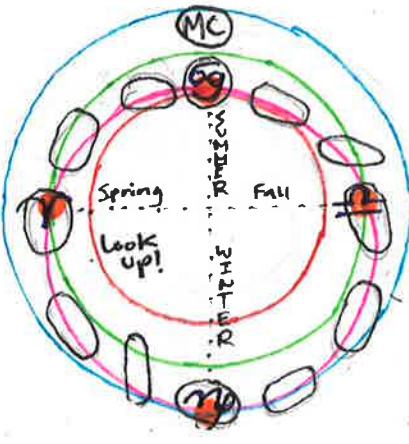
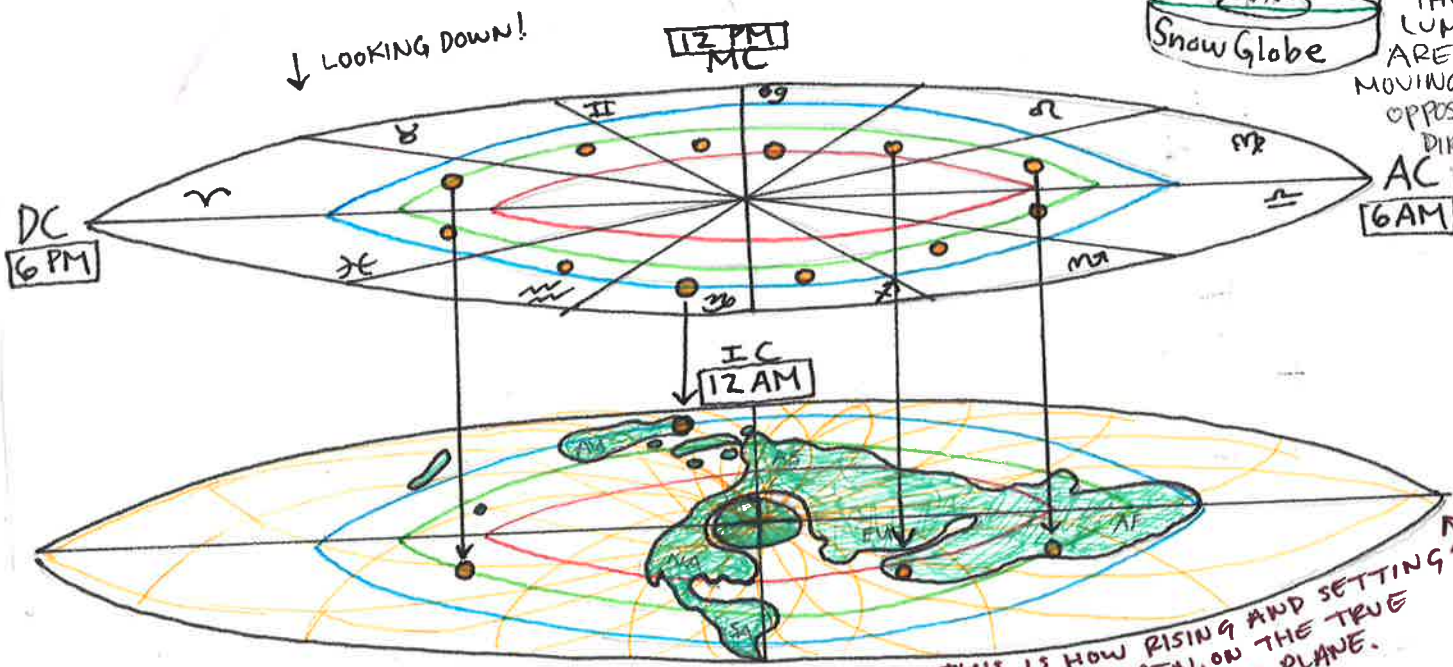



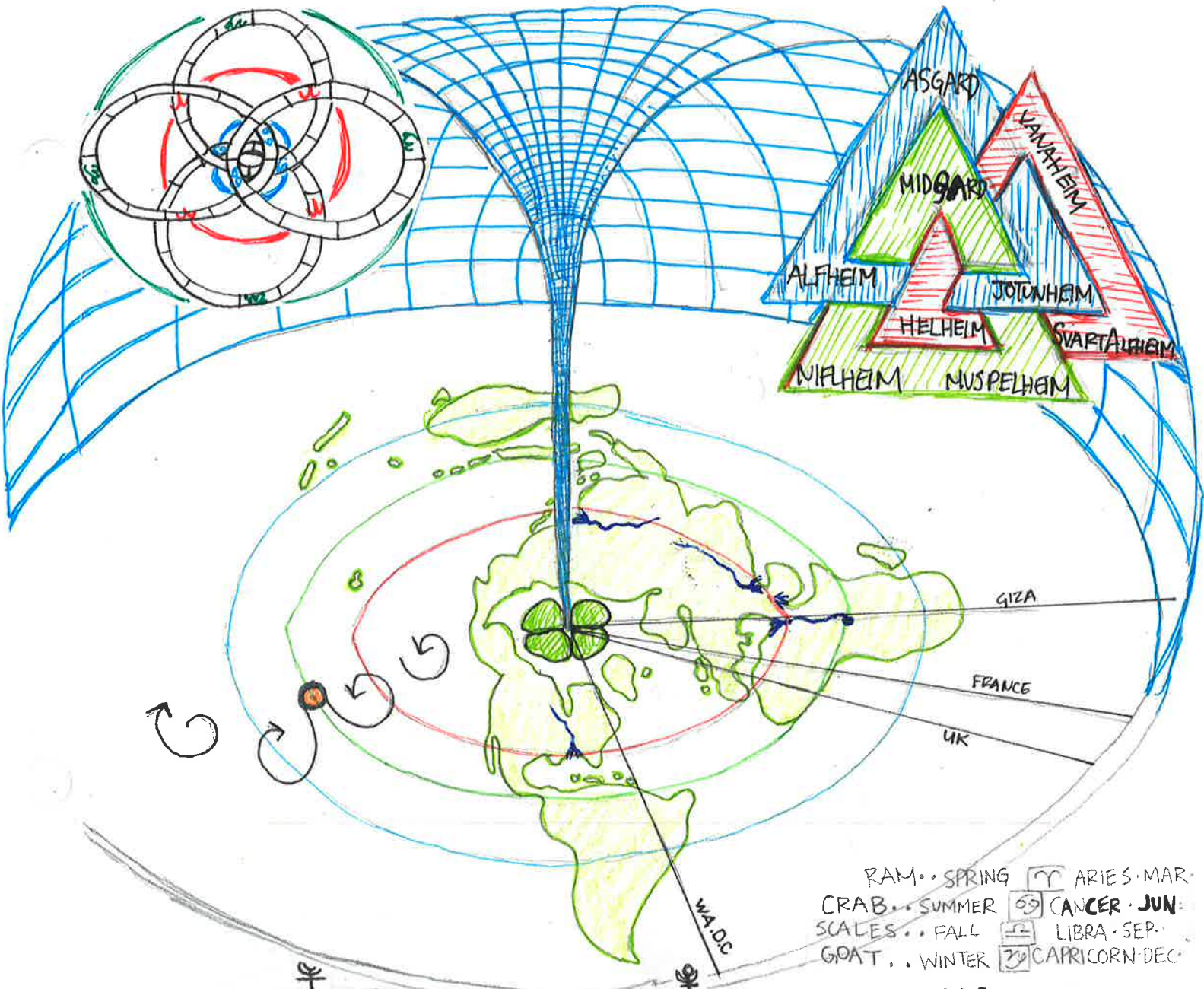

RAM • SPRING ♈ ARIES • MAR.  
 CRAB • SUMMER ♋ CANCER • JUN.  
 SCALES • FALL ♎ LIBRA • SEP.  
 GOAT • WINTER ♏ CAPRICORN • DEC.

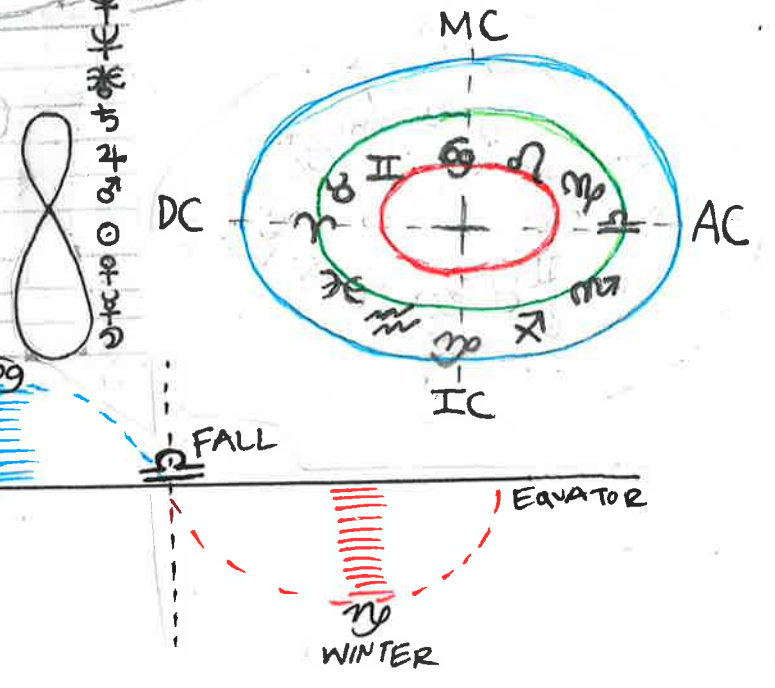
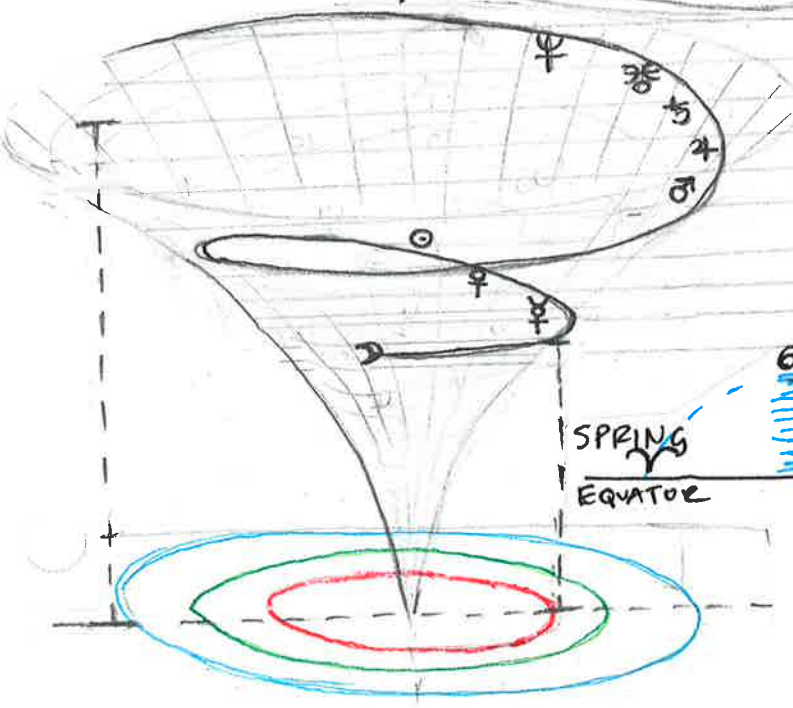



MANLY P. HALL - 3 COSMIC ZONES

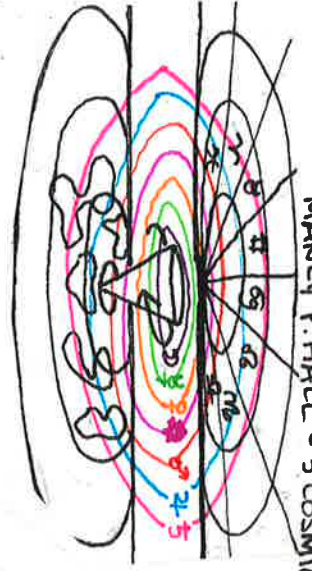

- ☉ 2 1/2 Days
- ♀ Forward 66 Days  
Backwards 22 Days (3 weeks)
- ♂ → 18 Months  
← 35 Days (5 weeks)
- ♁ 1 Month
- ♂ → 3 years  
← 3 months
- ♃ → 9 months  
← 3 months
- ♅ → 1 year  
← 6 months

→ Proceed ♈ → ♉  
← Retrograde ♉ ← ♈

The Sun has a 24 hour Daily Rotation around the North Pole.  
The Zodiacs Take 23 hours 56 minutes and 4.2 seconds to do a Full Rotation.

THE PRIMUM MOBILE



HERMETIC • TROPICAL ASTROLOGY

"Crystalline Sea"

"Ouranos = Heavens"

PTOLEMY'S  
GEOCENTRIC  
HORIZONTAL  
NEOPLATONIC  
SYSTEM

MOTHER NATURE  
ELEGANCE  
SIMPLICITY  
MINIMALISM  
@ ITS  
BEST!

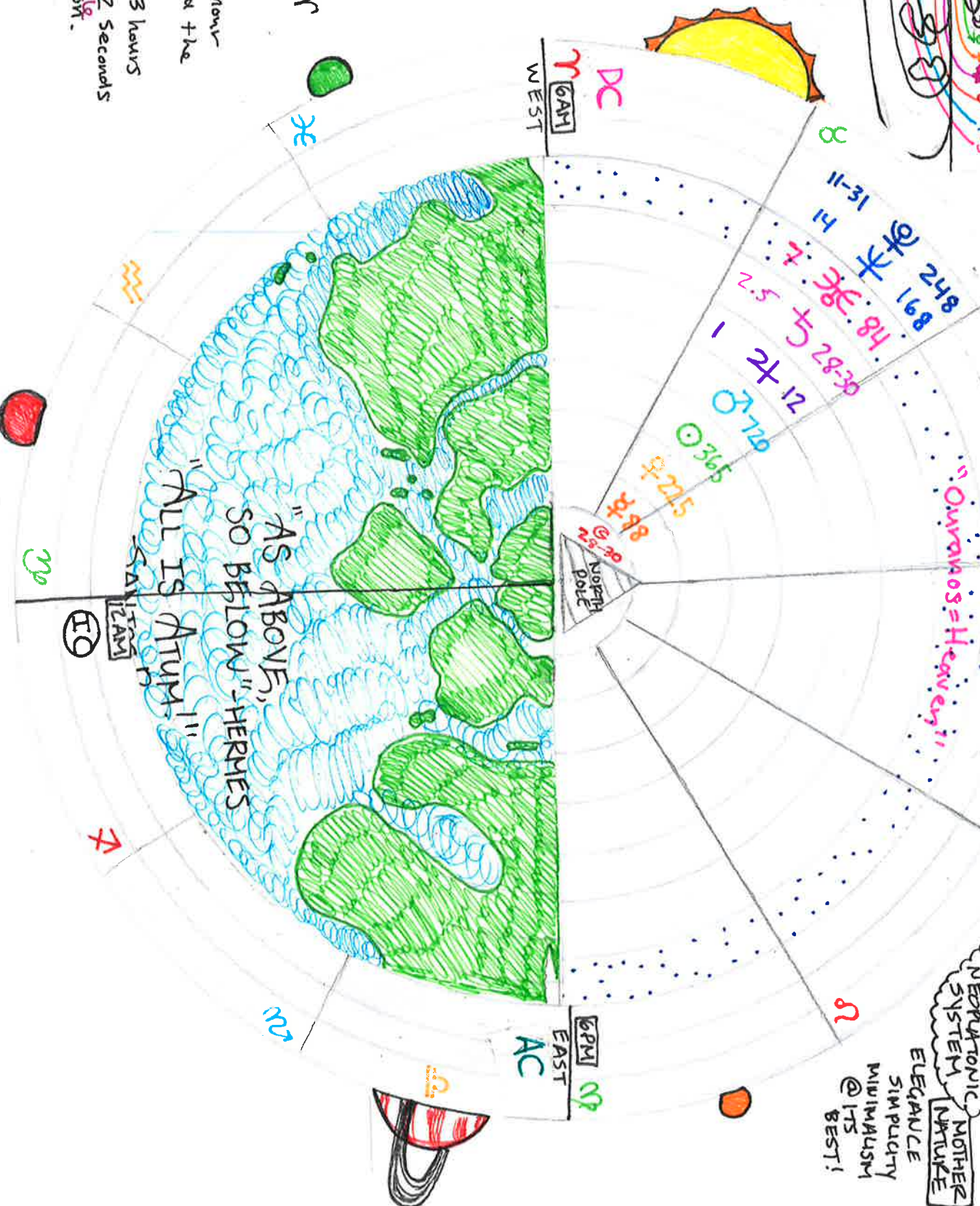

"AS ABOVE, SO BELOW" - HERMES  
"ALL IS ATUM"



**DR CARL JUNG** AS WE KNOW FROM ANCIENT EGYPTIAN HISTORY, THAT THESE EVENTS ARE SYMPTOMS OF PSYCHIC CHANGES THAT ALWAYS APPEAR AT THE END OF ONE PLATONIC MONTH, AND AT THE BEGINNING OF ANOTHER. THEY ARE, IT SEEMS, CHANGES IN THE CONSTELLATION OF PSYCHIC DOMINANCE OF THE ARCHETYPES OR GODS AS THEY USED TO BE CALLED, WHICH BRING ABOUT OR ACCOMPANY LONG LASTING TRANSFORMATIONS OF THE COLLECTIVE PSYCHE. THIS TRANSFORMATION STARTED WITHIN THE HISTORICAL TRADITION AND LEFT TRACES BEHIND IT. FIRST IN THE TRANSFORMATION FROM THE AGE OF TAURUS TO THAT OF ARIES, AND THEN FROM ARIES TO PISCES, WHOSE BEGINNING COINCIDES WITH THE RISE OF CHRISTIANITY. WE ARE NOW ENTERING THE GREAT CHANGE WHICH MAY BE EXPECTED, WHEN THE SPRING POINT ENTERED AQUARIUS.

**MANLY P. HALL** JUNG IS TELLING US THAT THE PLATONIC YEAR IS A PROBLEM IN TIMING, AND THAT WHAT WE CALL THE PRECESSIONAL MOTION OF THE EQUINOXES RESULT IN THE VERNAL EQUINOX CHANGING ABOUT EVERY 2000 YEARS, AND THAT THESE CHANGES CORRESPOND TO THE MONTHS OF THE GREAT PLATONIC YEAR WHICH CONSISTS OF SOMETHING OVER 25,000 YEARS. HE IS TELLING US THEREFORE THAT THESE CHANGES ARISING IN NATURE AND IN THE COSMOS ARE DUE TO CERTAIN GRADUAL TRANSFORMATIONS OF ARCHETYPES AND THAT THESE ARCHETYPES MEAN THAT IN NATURE THIS CLOCK IS ACTIVE, AND THAT THIS CLOCK IS CONTINUOUSLY MOVING, PASSING FROM ONE CYCLIC DIVISION TO ANOTHER. HE COULD UNDOUBTEDLY GATHER A POWERFUL BODY OF INFORMATION TO PROVE THAT EACH OF THESE VITAL PERIODS, THESE PERIODS IN WHICH THE GENERAL DOMINANT OF THE WORLD CHANGES, THERE HAS BEEN A MARK, AN IMPORTANT SOCIAL, PSYCHOLOGICAL CHANGE IN THE LIFE OF INDIVIDUALS. THIS PHENOMENA OF THE FLYING SAUCERS SHOULD ARISE AS THE VERNAL EQUINOX MOVES TO THE AQUARIAN POINT. THIS CONSEQUENTLY IMPLIES A MAJOR SHIFT FROM WATER TO AIR. THE ATMOSPHERIC MYSTERY, THE MYSTERY OF AIR AND THAT WHICH IS CONCEALED WITHIN AIR MUST BECOME INCREASINGLY PSYCHOLOGICALLY DOMINANT, FOR A PERIOD OF 2,000 YEARS TO COME.

~ THE AETHER ~

WE LIVE IN A HARMONIC UNIVERSE BUILT UPON A UNIFIED FIELD, AN UNSEEN FOUNDATION OF CONSCIOUS LOVING ENERGY KNOWN AS **ZERO POINT ENERGY** A UNIVERSAL ENERGY FORCE & SOURCE WHOSE EXISTENCE IS CRUCIAL FOR UNDERSTANDING OUR EXISTENCE AND IT IS THE CAUSE FOR OUR EXISTENCE.

"THE DAY SCIENCE BEGINS TO STUDY NON-PHYSICAL PHENOMENA IT WILL HAVE MADE MORE PROGRESS IN 1 DECADE THAN ALL PREVIOUS CENTURIES OF ITS EXISTENCE!" - NIKOLA TESLA.



# CYCLES OF CONSCIOUSNESS THE AGE OF AQUARIUS - THE AGE OF KNOWING (THE AGE OF ABUNDANCE)

WHEN THE WORLD'S SOUL IS FULL OF DARKNESS AND CORRUPTION, AND ONLY A SMALL FRACTION OF VIRTUE REMAINS, IT SLOWLY SWINDLES TO ZERO @ THE END OF THE KALI YUGA. MEN TURN TO WICKEDNESS, DISEASE, ANGER, ANGUISH, FEAR OF SCARCITY, AND LETHARGY; THESE DESCRIPTIONS REFLECT OUR CURRENT SOCIETIES PROGRESSION, A TIME WHERE GLOBAL TENSION HAS NEVER BEEN SO HIGH.

DURING THIS TIME WE HUMANITY HAVE INDEED EXPERIENCED THE MOST DARKNESS AND IT SEEMS THE MORE ANCIENT A CIVILIZATION THE MORE SPIRITUALLY AND TECHNOLOGICALLY ADVANCED THEY MAY HAVE BEEN.

AFTER THIS AGE WE WILL BE CYCLING BACK TO THE BEGINNING OF AN AGE THAT HASN'T BEEN SEEN SINCE A TIME OF GREAT KNOWLEDGE AND UNDERSTANDING OF THE SPIRITUAL SCIENCES, MYSTICISM, CONSCIOUSNESS, Gnosis.

THIS ALL SEEMS TO BE PART OF A MASSIVE SHIFT IN COLLECTIVE CONSCIOUSNESS THAT IS GOING ON TODAY. - THE SCIENCE IS CLEAR, PHYSIOLOGICAL RHYTHMS AND WORLDWIDE COLLECTIVE BEHAVIORS ARE NOT ONLY SYNCHRONIZED WITH SOLAR & GEOMAGNETIC ACTIVITY, BUT ALSO THAT DISRUPTIONS IN THE UNIVERSAL FIELD CAN CREATE ADVERSE EFFECTS ON HUMAN HEALTH AND BEHAVIOR.

AT A BIOLOGICAL LEVEL WE KNOW THAT ALL LIFE ON EARTH IS LINKED IN SOME WAY, WITH SOLAR, LUNAR AND POSSIBLY OTHER CYCLES AS WELL; THERE IS ALSO A GREAT DEAL OF EVIDENCE THAT HUMAN CONSCIOUSNESS IS DIRECTLY CONNECTED TO ASTROLOGY IN VERY PARTICULAR WAYS.

IN STEPHEN HAWKINGS 1988 BOOK "A BRIEF HISTORY IN TIME" HE PREDICTED THAT THE UNIFIED FIELD THEORY WOULD BE SOLVED IN 20 YEARS.

WE KNOW THAT THERE IS ALWAYS SOMETHING AND NEVER NOTHING. COUNTERSPACE (AETHER) IS THE NON-CARTESIAN NEXUS FROM WHICH ALL THINGS SPRING FROM & RETURN TO. DENYING THE EXISTENCE OF THE AETHER IS LIKE DENYING THE EXISTENCE OF THE SEED IN WHICH SEEDS COME FROM.

WHEN 2 MAGNETS ATTRACT EACH OTHER THEY'RE ACTUALLY ACCELERATING TOWARDS A NULL POINT BETWEEN THE 2 MAGNETS, ITS PRESSURE MEDIATION, THE AETHER IS TRYING TO REST SEEKING THE LOWEST PRESSURE ZONE.

THE DIMENSIONAL FORCE OF A MAGNET, HAS NO PROPERTIES, MASSLESS, SUBSTANCELESS ENERGY, ITS NOT A THING, ITS THE LOSS OF POTENTIAL, PURE IMPOTENCY. A BLACK HOLE IS WHEN DIELECTRICITY OVER-THROWS MAGNETISM, ITS MASS WITH NO MAGNITUDE. INERTIA WITHOUT VOLUME.

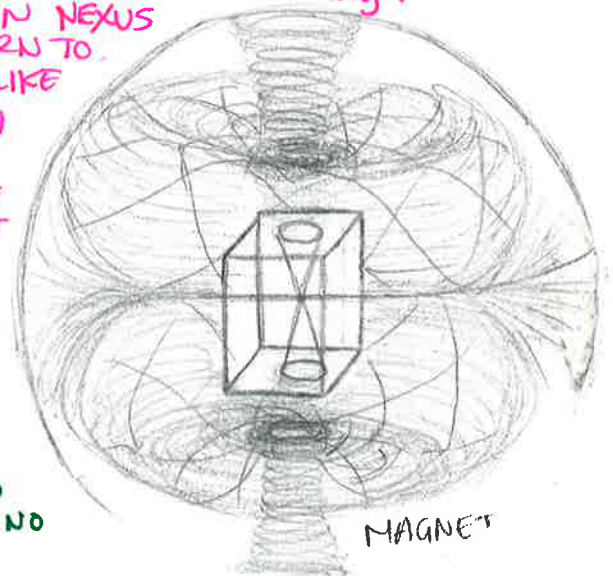



DID YOU KNOW THE GREAT PYRAMID ONCE MARKED THE "PRIME MERIDIAN" OF THE WORLD?

THERE IS A DEEP METAPHYSICAL MEANING TO THE PRIME MERIDIAN THAT INDEED RELATES TO THE CORE PRINCIPAL OF ALL METAPHYSICAL KNOWLEDGE, THAT HAS BEEN ATTAINED, AS WE SHALL DISCOVER, A PERCEPTION THAT IS VERY SIMPLE TO EXPLAIN, THE BEGINNING AND END POINT IN THE CYCLE, WHILE IT ALSO REPRESENTS THE AXIS MUNDI OF THE WORLD. THE PRIME OR ZERO MERIDIAN IS IMPORTANT IN THE RESPECT OF CYCLES BECAUSE LIKE THE GREAT PYRAMID IT REPRESENTS (ZERO POINT). THE PRIME MERIDIAN ORIGINALLY RAN THROUGH THE GIZA PLATEAU, AND WAS MARKED BY THE GREAT PYRAMID.

THIS MEANS THAT IT REPRESENTED (POINT ZERO) ON EARTH AND THEREFORE IT ALSO REPRESENTS ALPHA AND OMEGA.

IF EVERYTHING IS COORDINATED TO THE ZERO POINT MERIDIAN, THEN AS THE STARS ROTATE ABOVE OUR HEADS, THE DAILY CYCLE OF 360 DEGREES ROTATION AROUND THE CENTRAL NORTH POLE WOULD BEGIN AND END @ GIZA. THE GREAT PYRAMID IS POSITIONED ON THE GIZA MERIDIAN ALIGNED WITH THE NILE RIVER, THE NATURAL MERIDIAN OF EARTH.

FRENCH=NIL, GERMAN=NUL, LATIN=NULLUS

"THE KING OF THE WORLD WHO REMAINS ENTOMBED OR ASLEEP INSIDE OF A WHITE MOUNTAIN LOCATED @ THE CENTER OF THE EARTH, WITH THE EARTH'S AXIS RUNNING THROUGH IT. - ANY CITY THAT ADOPTS THE ZERO MERIDIAN WOULD BE RECOGNIZED AS THE CENTER OF THE WORLD! JUST LIKE ATLANTIS WAS, OR SO IT WAS SAID. - MOUNT ATLAS WAS THE VOLCANO AT THE AXIS OF THE ATLAS THAT CREATED ATLANTIS, WHICH PLATO CALLED "THE ISLAND OF THE ATLAS" - REFERRING TO THE ENTIRE WORLD.

COMING FROM THE EMERALD TABLETS OF THOTH, ALSO KNOWN AS HERMES TRISMEGISTUS OR MERCURY, THE "AS ABOVE SO BELOW" PRINCIPLE IS ESSENTIAL TO KNOWING THE TRUE HERMETIC PHILOSOPHY. THE MOUNTAIN/TREE AXIS ARCHETYPE DOES NOT JUST REPRESENT EARTH'S AXIS BUT ALSO THE PHYSICAL AXIS OF THE HUMAN BODY, THE SPINE AND THE ENDOCRINE GLANDS. - IT REPRESENTS THE PHYSICAL & INVISIBLE/METAPHYSICAL, AND THE PROCESSES ASSOCIATED WITH THE CHAKRAS, THE CEREBROSPINAL AXIS AND THE CENTRAL NERVOUS SYSTEM.

OUR ANCESTORS ALL OVER THE WORLD IN EVERY CULTURE BUILT THEIR TEMPLES AND PYRAMIDS IN THE FORM OF THE HUMAN BODY, AND THE BRAIN.

THERE IS A SPIRITUAL MT. MERY, IN INDIA, PERHAPS ANOTHER REFERENCE THAT STOOD @ THE CENTER OF ATLANTIS - IN ANCIENT CREATION MYTHS THIS MOUNTAIN ALSO REPRESENTS EARTH ITSELF, KNOWN AS THE SACRED OR (PRIMORDIAL MOUND)

IN SANSKRIT "ATALA" MEANS A BODE OF THE SERPENTS, & ALSO "PILLAR".

IN GREEK MYTHOLOGY "ATLAS" IS CURSED TO HOLD UP THE HEAVENS, MAKING HIM THE TREE THAT CONNECTS - EARTH TO HEAVEN. JUST LIKE OUR (C1)

"ATLAS" VERTEBRAE IS THE BONE THAT HOLDS UP OUR SKULLS OR THE HEAD, WHICH MEANS, ATLAS CONNECTS OUR BODIES TO THE HEAVENS. RIGHT UNDER THE C1 IS THE C2 VERTEBRAE CALLED THE AXIS.

IN SANSKRIT, MERUDANDA = SPINE

YGGDRASIL IN NORSE MYTHOLOGY IS THE WORLD TREE OR "AXIS MUNDI" (EARTH'S AXIS)

IN EGYPT THE "DJED PILLAR" WAS OSIRIS BACKBONE AND THE COSMIC TREE/PILLAR. - THE PYRAMIDS IN EGYPT WERE CALLED "MER" = A PLACE OF ASCENDANCE; AND THE WORD "PYRAMID" = PYRO-MID (MEANING "FIRE IN THE MIDDLE") SIGNIFYING THE VOLCANO @ THE CENTER OF THE ATLAS.

WE MUST UNDERSTAND THE ESOTERIC MEANING AND SIGNIFICANCE OF THE

GREAT PYRAMID AND ITS CENTRAL LOCATION ON EARTH. THE OBSESSION WITH THE PYRAMID, AND THE ZERO MERIDIAN WHICH RUNS THROUGH IT, AND THE NATIONS CAPITAL, IS NO LONGER A SECRET. THE GREAT PYRAMID REPRESENTED THE NAVAL OF THE WORLD (POINT ZERO) ON EARTH & IN EVERY CONTEXT THAT WE COULD APPLY THE TERM ZERO POINT.



REMEMBER:

The old French Meridian runs through The Observatory south of the Glass Pyramid within the Courtyard of the Louvre Museum in Paris.

-IT WAS BELIEVED THAT AFTER DEATH THE SOUL OF THE PHARAOH WOULD BE ABLE TO CLIMB THE SIDES TOWARDS THE RAYS OF THE SUN WHICH WAS REPRESENTED BY THE APEX OR CAPSTONE OF THE PYRAMID. THE GOLDEN CAPSTONE WHICH REDUCES TO A POINT, REACHING INWARDS AND UPWARDS TOWARDS THE "ZERO POINT" IS NOW MISSING. - THE CAPSTONE IS A MICROCOSMIC REPLICA OF THE WHOLE PYRAMID. THE APEX POINT REPRESENTS THE NON LOCAL CONNECTION - WHERE ALL THE ENERGY INFORMATION PERTAINING EVERYTHING IN THE KNOWN UNIVERSE IS TO BE SUPERIMPOSED OR FUSED AS ONE. - THE SUPREME BEING, THE SOURCE CENTER OF CREATION, AND INTELLIGENCE ITSELF. THE PYRAMID WITH ITS INCLINING EDGES THAT END IN A POINT IS A POTENT METAPHOR FOR ONE'S OWN SPIRITUAL CLIMB, OR ASCENT TO ENLIGHTENMENT AN INTERNAL PROCESS.

THE OCCULT FUNCTION OF MERIDIANS HAS TO DO WITH SPIRITUAL ORIENTATION, AND IN REFERENCE TO MEDITATION WOULD BE CALLED "ATONEMENT" OR "ATTUNE-MENT" = TUNING THE MIND TO CONNECT WITH ONENESS. "AT-ONE-MENT" = AT-ONE-MIND, MEANING BALANCED. THE 7TH MONTH IN HEBREW WHICH RELATES TO LIBRA AND THE BALANCE SCALES IS CALLED "TISHREI" WHERE "YOIM KIPUR" IS CELEBRATED, ALSO CALLED "JUDGEMENT DAY", WHICH MEANS "JUDGING THE MIND" - BALANCE.

IN THE MYSTICAL CONTEXT (ZERO POINT) IS COMMENSURATE WITH "THE ABSOLUTE" OR SILENT VOID WITHIN, WHICH IS ALWAYS @ THE CENTER BEYOND DUALITY. - IN TERMS OF PSYCHOLOGY THE VOID WOULD BE THE COLLECTIVE UNCONSCIOUS OR THE SUPERCONSCIOUS. FOR MANY OF US, THE SOURCE OF OUR VERY EXISTENCE IS CONCEALED BEHIND OUR OWN CONSCIOUSNESS OF IT, THE BLACK VOID OR SOURCE UNCONSCIOUS.

WE CAN ACCESS THE SOURCE WITHIN THROUGH TRANSCENDENTAL MEDITATION, A TECHNIQUE TAUGHT BY (MAHARISHI MAHESH) - YOGI, ALSO SHAMANIC TRANCE, TO ULTIMATELY BECOME CONSCIOUS OF IT. THE BLACK VOID OF UNCONSCIOUS TRANSFORMS INTO THE BRIGHT

LIGHT OF SUPERCONSCIOUS; THE "GOD HEAD" (THE POINT OF ENLIGHTENMENT) HOW ONE ACHIEVES THIS WAS ONCE THE MOST JEALOUSLY GUARDED SECRETS OF THE ANCIENT MYSTERY SCHOOLS. - IN BRIEF ONE IS REQUIRED TO JOURNEY WITHIN, ABOVE AND BEYOND ONE'S OWN DUALITY. THE SHAMAN WHILE IN TRANCE, REACHES THE TRUNK OF LIFE, THE WORLD TREE, OR THE CENTRAL AXIS OF THE WORLD MOUNTAIN, AND CLIMBS IT, THEN HE WILL REACH THE HIGHER PLANES WHERE A POWERFUL MYSTIC EXPERIENCE WILL RESULT. JACKS BEANSTALK, JACOBS LADDER, THE SPIRAL STAIRCASE... THESE ARE METAPHORS WHICH REFLECT AN INTERNAL PROCESS ASSOCIATED WITH THE SPINAL COLUMN AND THE SKULL OF THE SHAMAN HIMSELF. ONE COMES FACE TO FACE WITH THE INNER SUN THROUGH THE UNIVERSAL ENLIGHTENMENT EXPERIENCE. A PHENOMENON THAT CERTAINLY WAS AND STILL IS VERY FAMILIAR TO SHAMAN OF MANY INDIGENOUS CULTURES WORLD WIDE. THE GREAT PYRAMID IS FORMED FROM A SQUARE BASE WITH 4 INCLINING SIDES EACH ALIGNED WITH THE 4 POINTS OF THE COMPASS. IN MASONRY AND OCCULT, THE 4 AND SQUARE REPRESENT EARTH (THE CUPDOREAL WORLD) THE PYRAMID REPRESENTS ASCENSION FROM THE WORLD OF MATTER THROUGH SEVERAL DIFFERENT LEVELS UP TOWARDS THE "ZERO POINT" OF SINGULARITY! (THE SNAKE AND THE EAGLE JOIN)



## ~ THE VEGAN LIFESTYLE ~

THE CONCEPT OF PHILOSOPHICAL VEGANISM WAS BETTER DEVELOPED BY NEOPLATONISTS SUCH AS PLUTARCH, MARSILIO FICINO, GIORDANO BRUNO, PORPHYRE OF TYRE, AND LEONARD DA VINCI OF VENICE.

- IN HIS ESSAY OF ABSENCE FROM ANIMAL FOOD IN THE 2ND CENTURY, PORPHYRE SAYS THE CONCEPT OF JUSTICE SHOULD BE EXTENDED TO ANIMALS AS JUSTICE IN THIS CASE MEANS NOT TO COMMIT UNNECESSARY MURDER; MOST OF MEAT EATERS JUSTIFY THEIR CHOICE BY CLAIMING THAT ANIMALS ARE IRRATIONAL AND THEREFORE NOT SUBJECT TO THE SAME MORAL RULES.

- BUT PORPHYRE REFUTES THIS ARGUMENT BY SAYING THIS IS NOT A REASONABLE WAY OF THINKING AS THERE ARE HUMANS WHO ALSO LACK RATIONALITY, AND YET ARE PROTECTED BY MORAL RULES AGAINST MURDER, SOLELY BY BEING HUMAN; THUS HE SAYS, IT IS NOT COMPLETELY ACCURATE TO THINK ANIMALS ARE IRRATIONAL SINCE THEY HAVE MEMORY, FEELINGS AND PRUDENCE.

THE FACT THAT ANIMALS CANNOT COMMUNICATE PROPERLY TO US THEIR REASONING, SHOULD NOT MEAN THAT THEY ARE TO BE TREATED WITHOUT JUSTICE; JUST BECAUSE WE CANT UNDERSTAND THE LANGUAGE OF A FOREIGNER, IF HE COMES FROM A DIFFERENT COUNTRY, IT DOESNT MEAN THAT WE NOW HAVE THE RIGHT TO PUNISH HIM BECAUSE WE DONT UNDERSTAND WHAT HE OR SHE IS SAYING.

A TRUE PHILOSOPHER, MUST BE ABOVE THE SENSES.

EATING MEAT IS NOT CONSISTENT OF A PHILOSOPHICAL LIFE;

MARSILIO FICINO WAS ONE OF THE GREAT THINKERS WHO ARGUED THAT A VEGAN LIFESTYLE COULD HELP A PERSON ELEVATE CONSCIOUSNESS, AND PURIFY THE BODY; HE ENCOURAGED HIS FOLLOWERS TO BECOME VEGAN AND ABSTAIN FROM ANYTHING THAT COULD ENSLAVE THE SENSES, SUCH AS THE KIND OF BODILY PLEASURES THAT COULD DOMINATE THE MIND. IN THE PAST MANY PHILOSOPHERS WERE VEGAN, FOR DIVERSE REASONS; PLATONISTS AND LATER NEO-PLATONISTS. - THEY ARGUED THAT EATING MEAT WAS A MATTER OF ETHICS, IF HUMANS HAVE THE POWER TO CHOOSE BETWEEN ANIMALS BEING SACRIFICED AND VEGANISM, WHY CHOOSE THE OPTION THAT LEADS TO DEATH AND SUFFERING OF SO MANY CREATURES INSTEAD OF CHOOSING NOT TO KILL.

IN PLATOS IDEAL SOCIETY, HE ASKS "WHAT LOSS HAVE YOU IN LOSING YOUR CRUELTY?" - "I MERELY DEPRIVE YOU OF THE FOOD OF LIONS AND VULTURES, WE SHALL RECOVER OUR SOUND REASON ONLY IF WE SHALL SEPERATE FROM THE HERD. LET US ASK "WHAT IS BEST" NOT WHAT IS CUSTOMARY. LET US BE JUST AND REFRAIN FROM BLOODSHED, AND LOVE TEMPERANCE."

PLATO - "NONE IS CLOSEST TO GOD AS HE WHO SHOWS KINDNESS!"

HIPPOCRATES - "IN ORDER TO HEAL SOMEONE, FIRST ASK THEM IF THEY ARE WILLING TO GIVE UP, THAT WHICH MAKES THEM SICK."



## "PLATO'S PERFECT PLACE" [A STATE BASED ON JUSTICE] (NO EATING OF FLESH)

TO HELP CITIZENS GROW SPIRITUALLY, WE MUST NOT LET THE INSTINCTS OVERSHADOW THE PRINCIPLES.

PLATO CALLED MEAT EATING "TYRANNY OF THE SENSES" WHEN THE INTELLECT LEARNS THAT SOMETHING IS IMMORAL BUT THE PHYSICAL BODY IGNORES THE PRINCIPLE IN THE NAME OF BODILY SATISFACTION, IT SHOWS WEAKNESS IN INTUITIVENESS.

HOW LONG SHALL WE FILL OUR PLANES WITH HUGE CITIES, HOW LONG SHALL PEOPLE SLAVE FOR US UNNECESSARILY, HOW LONG SHALL COUNTLESS NUMBERS OF SHIPS FROM EVERY SEA ON EARTH BRING US PROVISIONS FOR THE CONSUMPTION OF A SINGLE MONTH. (AN OX IS SATISFIED WITH THE PASTURE OF AN ACRE OR 2; 1 ACRE WOULD SUFFICE FOR SEVERAL ELEPHANTS) - MAN ALONE SUPPORTS HIMSELF BY THE PILLAGE OF THE WHOLE EARTH AND SEA. WHAT!? HAS NATURE INDEED GIVEN US INSATIABLE STOMACHS WHILE SHE HAS GIVEN US INSIGNIFICANT BODIES? - NO. IT IS NOT THE HUNGER OF OUR STOMACHS, BUT THE INSATIABLE COVETOUSNESS THAT COSTS SO MUCH.

- NOTE THE QUANTITY OF LIVES ON STOMACH ABSORBS. TRAPS, NETS, GUNS, SPEARS AND HOOKS. THERE IS NO PEACE FOR INNOCENT CREATIONS.

THERE HAS NEVER BEEN A TIME IN HISTORY UNTIL NOW, WHERE WE NEED A SUPER NUMERARY FORCE OF MEDICAL MEN. SO MANY SURGICAL INSTRUMENTS AND SO MANY BOXES OF DRUGS.

HEALTH USED TO BE SIMPLE, FOR THE SIMPLE FACT THAT AN APPLE DAY KEEPS THE DOCTORS AWAY. - SO MANY DISHES HAVE INDUCED SO MANY DISEASES WHICH IS EVER VARYING.

COUNT THE # OF COOKS, AND YOU WILL NO LONGER WONDER @ THE INNUMERABLE NUMBER OF HUMAN MALADIES.

PEOPLE AREN'T NATURALLY CARNIVOROUS, BUT GLUTTONY MAKES THEM CRUEL, AS THE DESIRE TO PLEASE THE SENSES WITH THE TASTE OF FLESH BECOMES MORE IMPORTANT THAN THE LIFE OF THE OTHER LIVING CREATURES.

ALLOWING ANIMAL SLAUGHTER UNNECESSARILY INDICATES THAT MUCH ARE BEING DOMINATED BY THEIR BODIES; IN ACCORDANCE TO THE PLATONIC PHILOSOPHY, NEO PLATONISTS BELIEVE THAT THE MIND SHOULD GOVERN MEN'S PRINCIPLES AS THE USE OF INTELLECT IS ONE OF THE THINGS THAT DIFFERENTIATE THE HUMANS FROM ANIMALS, AND WHEN THE BODY INSTINCTS TAKE OVER, MEN ARE EASILY CORRUPTED. SO THE ONLY REASON WHY PEOPLE DO NOT WANT TO GIVE UP EATING ANIMALS IS BECAUSE EATING FLESH PLEASURES THE SENSES.

THE IDEA IS TO TRANSCEND THE PHYSICAL LIMITATIONS AND THATS THE 7 VICES; AND DISCIPLINE OURSELVES TO PRACTICE AND INTEGRATE THE 7 VIRTUES.

LEONARDO DA VINCI TOOK PITY ON ANIMALS AND BOUGHT LIVE BIRDS FROM THE MARKET TO FREE THEM. HE SAID KILLING ANIMALS JUST TO SATISFY ONE'S DESIRE FOR FLESH IS ABSURD, AND IT DETESTS THE HUMAN INCAPABILITY OF HAVING CONTROL OVER THE SENSES. THE NEO PLATONISTS BELIEVED THAT ANIMALS REINCARNATE AS HUMANS THEREFORE ARE WORTHY OF RESPECT.



VEGANISM CORONAVIRUS TEN COMMANDMENTS  
SAVING ME CARNIVOROUS CANT MEND MOST MEN

"EAT TO LIVE." DR. SEBI  
"FEED YOUR MIND, NOT YOUR BODY." SANTOS B.

LEONARDO DAVINCI - TRULY MAN IS THE KING OF BEASTS, FOR HIS BRUTALITY EXCEEDS THEM. WE LIVE BY THE DEATH OF OTHERS. WE ARE BURIAL PLACES. I HAVE SINCE AN EARLY AGE ABJURED THE USE OF MEAT.

PYTHAGORAS - AS LONG AS MEN MASSACRE ANIMALS THEY WILL KILL EACH OTHER. INDEED HE WHO SOWS THE SEEDS OF MURDER AND PAIN CANNOT REAP JOY AND LOVE.

PLATO - THE UPPERCLASS SHOULD REFRAIN FROM EATING MEAT.

BUDDHA - TO AVOID CAUSING TERROR TO LIVING BEINGS, LET THE DISCIPLE REFRAIN FROM EATING MEAT. THE FOOD OF THE WISE IS THAT WHICH IS CONSUMED BY THE SADHUS; IT DOES NOT CONSIST OF MEAT.

MAHATMA GANDHI - I DO FEEL THAT SPIRITUAL PROGRESS DOES DEMAND AT SOME STAGE THAT SHOULD CEASE TO KILL OUR FELLOW CREATURES FOR THE SATISFACTION OF OUR BODILY WANTS.

THOMAS EDISON - NON VIOLENCE LEADS TO THE HIGHEST ETHICS WHICH IS THE GOAL OF ALL EVOLUTION. UNTIL WE STOP HARMING ALL LIVING BEINGS, WE ARE ALL SAVAGES.

ALBERT EINSTEIN - IT IS MY VIEW THE VEGETARIANISM MANNER OF LIVING BY ITS PURELY PHYSICAL EFFECT ON THE HUMAN TEMPERMENT WOULD MOST BENEFICIALLY INFLUENCE THE LOT OF MANKIND.

All scriptures condemn meat eating - Santos Bonacci **GENESIS 1:29**

PRATEEK KOHLI - THE REABSORPTION OF THE SEMINAL FLUID BACK INTO THE BLOOD STREAM IS THE BEST NUTRITION YOUR BODY CAN EVER GET, SO CONTROL YOUR LUST AND DONT WASTE SEMINAL FLUID FOR SHORT TERM PLEASURES.

ALL SCRIPTURES AND RELIGIONS HAVE A SPIRITUAL PROTOCOL FOR SEXUALITY THROUGH THE GUIDANCE SYSTEM (S.E.X) WHICH STANDS FOR SACRED ENERGY XCHANGE... A DIVINE GIFT. THIS IS WHY SPIRITUAL PEOPLE WOULD GO TO SEMINARIES TO BECOME PRIESTS AND PRIESTESSES THROUGH THE SEXUAL FLUIDS IN THE SEMENARIES. NON-EJACULATORY SEX OR WHITE TANTRA IS SEMEN RETENTION FOR MALES, ANYTHING ELSE IS CONSIDERED BLACK OR GREY TANTRA... THIS IS MIS-USE OF SEX, THE BODY, THE MIND AND THE CONSCIOUSNESS. IT ATTRIBUTES TO MISERY, AND IT SUPPORTS THE ABORTION INDUSTRY, AND ENABLES IT. BLACK TANTRA CONTRIBUTES TO THE ATTACK OF CONSCIOUSNESS, AND THINGS LIKE VENERIAL DISEASES. WHEN YOU LEARN TO CONTROL THE COILED SERPENT, OR DRAGON ENERGY, YOU'RE IN A ROMANTIC MODE, AND NOT ANIMAL LIKE BEHAVIOR AND DISRESPECT... THIS ALSO AMOUNTS TO UNWANTED CHILDREN AND RELATIONSHIPS. WE HAVE A CERTAIN AMOUNT OF CHRISM WHICH GIVES US OUR CHARISMA, WHICH IS ALLOCATED AT BIRTH. ITS THE QUINTESSENCE.

"WHEN YOU BREATHE SLOWLY AND PROPERLY YOU LIVE LONGER!"  
- SANTOS BONACCII!

NIKOLA TESLA - EINSTEIN IS A BEGGAR WRAPPED IN PURPLE CLOTHING THAT IGNORANT PEOPLE TAKE FOR A KING.



QUANTUM MECHANICS IS DEALING WITH THE MATHEMATICAL DESCRIPTION OF THE MOTION AND INTERACTION OF SUBATOMIC PARTICLES, INCORPORATING THE CONCEPTS OF QUANTIZATION OF ENERGY.

QUANTIZATION IS THE CONCEPT THAT A PHYSICAL QUANTITY CAN HAVE ONLY CERTAIN DISCRETE VALUES, LIKE ATOMS IN MATTER, THE # OF ELECTRONS IN ATOMS AND THE QUANTIZATION OF ENERGY IN ELECTRONS.

QUANTUM MECHANICS IS INDEED INCOMPLETE THAT IT CANNOT PREDICT SIMULTANEOUSLY THE POSITION AND MOMENTUM OF A PARTICLE, NOR THE REAL PATH OF A PARTICLE BETWEEN MEASUREMENTS. QM IS ONLY A STATISTICAL THEORY AS EINSTEIN MAINTAINED.

THE E.P.R PARADOX STATES THAT THERE IS A MISSING CONCEPT OR MATERIAL IN QUANTUM THEORY THAT CLAIMS THAT EVERYTHING IN THE UNIVERSE IS MADE OF PARTICLES.

THE E.P.R PARADOX IS A THOUGHT EXPERIMENT PROPOSED BY ALBERT EINSTEIN, BORIS PODOLSKY AND NATHAN ROSEN. THE THOUGHT EXPERIMENT INVOLVES A PAIR OF PARTICLES IN AN ENTANGLED STATE. THEY ARGUED THAT NO ACTION TAKEN ON THE FIRST PARTICLE COULD INSTANTANEOUSLY AFFECT ANOTHER SINCE THIS WOULD INVOLVE INFORMATION BEING TRANSMITTED FASTER THAN LIGHT WHICH IS FORBIDDEN BY THE THEORY OF RELATIVITY.

EINSTEIN PROPOSED THAT LIGHT WAS NOT SIMPLY MADE UP OF WAVES IT, COULD ALSO BE THOUGHT OF AS DISCRETE INDIVIDUAL PARTICLES OR QUANTA. THIS THEORY BECAME ONE OF THE FOUNDATIONS OF QUANTUM MECHANICS.

QUANTUM ENTANGLEMENT OR SPOOKY ACTION AT A DISTANCE AS EINSTEIN CALLED IT, IS THE IDEA THAT THE FATES OF TINY PARTICLES ARE LINKED TO EACH OTHER EVEN IF THEY ARE SEPERATED BY LONG DISTANCES.

ALBERT EINSTEIN SAID THAT LIGHT BEHAVES AS BOTH A PARTICLE AND A WAVE, AND HIS THEORY OF RELATIVITY CLAIMED THAT THE SPEED OF LIGHT IS THE MAXIMUM SPEED OF THE UNIVERSE.

NIKOLA TESLA KNEW THERE WAS NO SUCH THING AS VIRTUAL PHOTONS, PARTICLES, MAGNETRONS OR GRAVITONS, AND THAT THE UNIVERSE WAS SIMPLE. HE KNEW THE NOTION AND CONCEPT OF A PHOTON WAS COMPLETELY ARBITRARY AND HAD NO BASIS TO DECORATE A PHOTON AS A PARTICLE IS ILLOGICAL - ALL "SOLID MATTER" IS COMPRISED OF

NON-SOLID ENERGIES VIBRATING AT A CERTAIN FREQUENCY - WALTER RUSSEL  
LIGHT IS A PRINCIPLE WHICH CAUSES ILLUMINATION, WHICH IS NOT AN EMISSION; IT IS A WAVE MOTION OF DEFINITIVE VELOCITY. THE "SPEED OF LIGHT" OR MORE CORRECTLY 'ILLUMINATION' IS THE HYSTERESIS OF THE AETHER; ITS THE MAXIMUM RATE OF INDUCTION OR BUNCHING UP OF THE MEDIUM. THE 'SPEED OF LIGHT' OR MAXIMUM RATE OF PROPOGATION IS DETERMINED BY THE ELASTIC FORCE 'ELASTICITY' OF THE MEDIUM, LIKE GLASS AND WATER FOR EXAMPLE.

THE RATE OF INDUCTION OF SOUND CHANGES WITH AIR PRESSURES AND AIR DENSITY AS WELL AS TEMPERATURE. - THINK ABOUT CAVITATION PROPELLERS AND HOW AIR PRESSURES CAN EFFECT BOILING POINTS. CERTAIN PRESSURES CAN EFFECT AIR DENSITY WHICH CAN ALTER THE SO CALLED SPEED OF SOUND AND LIGHT.

WHEN WE SPEAK WE CREATE A DISTURBANCE IN THE MEDIUM, ITS A DISTURBANCE IN THE OXYGEN AND NITROGEN, BUT IF SOMETHING HAS A SPEED THEN IT MOVES A TO B. THE BUNCHING UP AND CURLING UP & DOWN MOTION OF WATER. A SOUND WAVE IS LIKE AN OCEAN WAVE... ITS A SEQUENCE OF MOTION, UP AND DOWN MOVEMENT, OF THE MEDIUM.



THE "NEW" PHYSICS OF THE 21<sup>ST</sup> CENTURY TELLS US THAT THE VERY BUILDING BLOCKS OF LIFE, ATOMS AND MOLECULES THEMSELVES ARE NOT PARTICLES AT ALL; INSTEAD THEY ARE NOTHING MORE THAN TOROIDAL WHIRLPOOLS OF ENERGY, IN THIS FLOWING RIVER OF AETHER.

UP UNTIL THE 20<sup>TH</sup> CENTURY ALL WESTERN SCIENTIFIC TRADITION KNEW THAT SUCH AN ENERGY FORCE EXISTED GOING BACK TO THE ANCIENT GREEK PHILOSOPHERS AND MOST LIKELY TO A FAR OLDER CIVILIZATION WITH ADVANCED SCIENTIFIC KNOWLEDGE.

THE AETHER FLUID THAT SURROUNDS US IS A SOURCE OF TREMENDOUS ENERGY THAT IS IN CONSTANT VIBRATIONAL MOTION FLOWING THROUGH ALL OBJECTS IN THE UNIVERSE. IF THE AETHER SHOULD EVER STOP FLOWING AND SWIRLING ABOUT WITH SUCH AN INTELLIGENT PURPOSEFUL BEHAVIOR, ALL MASS WOULD GRADUALLY DISSOLVE AND RETURN TO ITS PRIMORDIAL ENERGY STATE. (THE FLAME WILL GO OUT)

THE KEY POINTS THAT CAN CONNECT THE CONCEPT OF AETHER, LOVE AND PHYSICS IS THE IDEA OF SYMPATHETIC VIBRATIONS; ALL OF THE FUNDAMENTAL FIELDS MUST EMANATE DIRECTLY FROM THE AETHER. THE UNIFYING FORCE OF INFORMATION THAT FORMS ALL PHYSICALITY AS WE KNOW IT.

THE UNIFIED FIELD IS PURE ENERGY, AND IF THE ENERGY MUST MOVE TO FORM ALL OF PHYSICALITY THEN ULTIMATELY CONSCIOUSNESS IS ANOTHER FORM OF AETHERIC MOVEMENT. THUS A PROPERLY TRAINED PERSON CAN USE THEIR CONSCIOUSNESS TO CREATE MOTION IN THE AETHER. - ALL CONSCIOUSNESS PROCESSES ARE CAPABLE OF MOVING MUCH MORE QUICKLY AND THEREBY EXHIBITING HIGHER INTELLIGENCE AND LOVE WHERE ENERGY ITSELF IS MOVING MUCH MORE QUICKLY. WHEN A WAVE MOVES THROUGH A MEDIUM, YOU HAVE A HIGHER AMOUNT OF VIBRATIONAL MOVEMENT IN THE WAVE THAN YOU DO IN THE REST OF THE MEDIUM.

THE STARS, THE SUN, THE MOON AND LUMINARIES ARE CONSCIOUS IN THEIR OWN RIGHT, SINCE THEY ARE FORMED BY CONSCIOUS AETHER IN VIBRATIONAL MOTION, AND THEY NATURALLY CREATE DISTURBANCES AS THEY TRAVEL THROUGH THE HEAVENS.

THE ENTIRE UNIVERSE IS COMPOSED OF A UNIFIED FIELD OR ONE UNIFIED CONSCIOUS ENERGY SOURCE, SO WE ARE ALSO A PART OF THAT FIELD. OUR CONSCIOUSNESS CAN INTERACT WITH IT AT MANY LEVELS.

THE FUNDAMENTAL NATURE OF GODS ENERGY IS LOVE AND LIGHT. THE WHOLE UNIVERSE CHANGES AS WE CHOOSE TO REUNITE IN ONENESS; UNITY OR ONENESS IS A POINT OF SINGULARITY WHERE ALL VIBRATIONS BECOME SIMULTANEOUS. LIGHT, SPACE AND TIME MERGE INTO A MOMENT CENTER. THE HIGHER THE VIBRATIONS RISE THE MORE STABLE AND UNIFIED THE COMPOSITION WILL BECOME. LOVE IS THE TENDENCY FOR ENTITIES WITHIN THE UNIFIED FIELD WHETHER HUMAN, ~~ROBOT~~ ANIMAL, PLANT OR MINERAL, TO INCREASINGLY VIBRATE TOWARDS HARMONIC UNITY OR ONENESS

(WORLD PEACE!) → LOVE IS ENERGY IN MOTION = EMOTION → RADIATION OF LOVE FOR THE COLLECTIVE CONSCIOUSNESS EVERYONE COUNTS!

THE RADIANCE OF LOVE CAN BE FELT PERSON TO PERSON, IN THE SAME WAY THAT A WAVE EXHIBITS MOTION THROUGH A GIVEN MEDIUM. THE FEELING OF LOVE CAUSES MORE MOTION IN THE NERVOUS SYSTEM, HEART RATE ACCELERATES, SKIN CONDUCTIVITY CHANGES, AND NEUROLOGIC PROCESSES FLOW MORE QUICKLY..



THE AETHER WAS SUPPOSEDLY PROVEN TO BE FALSE BY THE MICHAELSON MORLEY EXPERIMENT AT THE BEGINNING OF THE 20TH CENTURY AND MOST SCIENTISTS STILL BELIEVE IT DOESN'T EXIST BECAUSE OF POOR UNDERSTANDING. THERE ARE MORE AND MORE RESEARCHERS WHO ARE UNAFRAID TO USE THE FORBIDDEN WORD **AETHER** ESPECIALLY WHEN DISCUSSING **ZERO POINT ENERGY** WHICH IS THE FLOWING BACKGROUND SUBSTANCE OF THE UNIVERSE THAT CAN BE PROVEN TO EXIST EVERYWHERE.

ALL AGREE THAT OUR PHYSICAL REALITY ARISES FROM THE HIDDEN ENERGY SUBSTANCE WHICH CREATES ALL WE KNOW AND SEE BY VIBRATING, AND THUS LIKE FISHES IN THE SEA, THE PRESSURES OF THIS ENERGETIC FLUID CONSTANTLY SURROUNDS US THOUGH WE DO NOT NORMALLY NOTICE ITS PRESENCE. THE WORD AETHER HAD ESSENTIALLY BECOME TABOO AFTER THE MICHAELSON MORLEY EXPERIMENT IN 1887, EVEN THOUGH ALL HE DID WAS TECHNICALLY PROVE THAT THERE WAS NO EXISTENCE OF A MATERIAL AETHER, WHICH WOULD BE HANGING IN THE AIR LIKE GAS. THE ORIGINAL IDEA FOR THIS EXPERIMENT WAS NOT TO PROVE OR DISPROVE THE AETHERS EXISTENCE, IT SIMPLY WAS TO MEASURE HOW MUCH OF IT WAS THERE.

THE EXPERIMENT PROPOSED THAT AS EARTH MOVED THROUGH SPACE THERE WOULD BE A DRAG OF AETHERIC SUBSTANCE THAT COULD BE MEASURED IN THE DIRECTION OF EARTH'S TRAVEL SIMILAR TO RIPPLES IN A POOL OF WATER AS YOU MOVE YOUR HAND THROUGH. THE MICHAELSON MORLEY EXPERIMENT DID NOT DISPROVE THE EXISTENCE OF A NON MATERIAL ENERGY SOURCE SUCH AS ZERO POINT ENERGY.

THE ONLY MOTION DETECTED BY THE EXPERIMENTS OF MORLEY WAS A  $15^\circ$  DEGREE PER HOUR ROTATION WHICH IS EQUAL TO A FULL  $360^\circ$  DEGREES OVER A 24 HOUR PERIOD, NO OTHER MOTION WAS DETECTED. NO 30 KM Per Sec. 66,600 MPH

ANOTHER IMPORTANT MISUNDERSTANDING THAT SHOULD BE CORRECTLY UNDERSTOOD IS THE EXPERIMENT CALLED AIRYS FAILURE WHICH WAS TEST CONDUCTED BY ASTROLOGER ROYAL SIR GEORGE BIDDEL AIRY IN 1871; IN WHICH AIRY FAILED TO DETECT MOTION OF THE EARTH. THE EXPERIMENT SHOWED THAT THE STARS MOVE RELATIVE TO A FIXED EARTH; FIRST BY FILLING A TELESCOPE WITH WATER TO SLOW DOWN THE SPEED OF LIGHT INSIDE, THEN CALCULATING THE TILT NECESSARY TO GET THE STARLIGHT DIRECTLY DOWN THE TUBE. AIRY UNINTENTIONALLY DEMONSTRATED THAT THE EARTH WAS FIXED HORIZONTALLY SINCE THE STARLIGHT CAME IN AT THE CORRECT ANGLE WITHOUT NEEDING TO CHANGE THE TILT OF THE TELESCOPE.

NIKOLA TESLA CALLED "OUTER SPACE" THE LUMENIFEROUS AETHER.... BECAUSE THE LUMINARIES ARE CARRIED BY THE AETHER. HE SAID THAT "LIGHT CAN BE NOTHING LESS THAN A SOUND WAVE IN THE AETHER". HE ALSO SAID "SPACE HAS NO ATTRIBUTES" .... REFERRING TO THE MAGNETIC FIELD OR THE LOVE FREQUENCY... OR ZERO POINT ENERGY....

WHAT IS ZERO POINT ENERGY? THIS ENERGY IS FOUND AT ABSOLUTE ZERO DEGREES WHERE THERE SHOULD BE NO HEAT OR ANY OTHER FORM OF ENERGY REMAINING, THE 2ND REASON IS THAT THE PRESSURES OF THIS ENERGY FIELD USUALLY CANCEL OUT TO ZERO; WHAT IS KNOWN AS **ZERO VECTOR RESULTANT**... IF YOU PUT A GAUSS METER BETWEEN 2 MAGNETS YOU WILL FIND **ZERO GAUSSIAN FLUX**



FUN FACT: NO MODERN PHYSICISTS CAN PREDICT THE POSITION, MOMENTUM OR THE REAL PATH OF A PARTICLE BETWEEN MEASUREMENTS ... DUE TO THE LACK OF AN UNDERSTANDING OF THE TRUE CONCEPT OF AN ATOM OF COURSE; OR MORE BLUNTLY DUE TO THE "DENIAL OF THE AETHER".

AN ATOM IS ALL ONE MOTION; A PERPETUAL MOTION MACHINE THAT IS DRIVEN BY 'ZERO POINT ENERGY' — KEN WHEELER CALLS THE ATOM A "HYPERDIMENSIONAL STARGATE." — WHICH IS COMPLETELY ACCURATE BECAUSE WITHOUT MOTION, ALL PHYSICALITY WOULD DEMANIFEST AND RETURN TO ITS PRIMORDIAL STATE, WHICH IS UNCONDITIONAL, IMMUTABLE, UNBOUNDED CONSCIOUSNESS... POWER, & BLISS (DYNAMIC PEACE) (INFINITE CREATIVITY) UNLIMITED POTENTIAL, PURE ENERGY.

THIS EXPLAINS WHY AN ELECTRON DOESN'T RADIATE AWAY ALL OF ITS ENERGY, AS IT SHOULD IF IT WERE ACTUALLY AS OUR CURRENT MODELS SHOW US; BEING A CHARGED PARTICLE. — THE TRUTH IS ELECTRONS ARE NOT SEPERATED FROM THE NEUTRON OR THE PROTON, NOR DO THEY CARRY THEIR OWN CHARGE... THE ELECTRON IS LIKE YOUR BLUE BLOOD, ITS JUST A DEOXYGENATED FORM OF THE SAME RED BLOOD THAT LEFT THE LUNGS TO SPREAD THE OXYGEN AND KEEP ORGANS ALIVE, AND IT MUST RETURN TO THE LUNGS TO REPEAT THE PROCESS, WHILE THE HEART IS THE PUMP THAT IS CONSTANTLY DRAWING IN & PUSHING OUT AT THE SAME TIME, A SINGLE FLOW. — THE ELECTRON IS CONSTANTLY DRAWING ENERGY FROM THE SOURCE CENTER OF THE ATOM, RESULTING IN ETHERNAL FLUX.

✓ SNAKES & LADDERS!

THE BINARY CONJUGATES OF REALITY (SPIRIT & MATTER) THE COETERNAL PRINCIPLES OF LIFE... CONSTRUCTIVE & DESTRUCTIVE INTERFERENCE. KEN W. CALLS IT THE INSEPERABLE WHOLOS, JUST LIKE THE YIN & YANG, WHICH IS

THE MIRROR IMAGE OF A SINGLE ETERNITY, AND IT REPRESENTS THE CONCEPT THAT EVERYTHING IN THE UNIVERSE CONSISTS OF THESE 2 SYMBIOTIC FORCES, OF DARKNESS & LIGHT; THE OUROBOROS IS THE SAME IDEA OF THE "GENERATION & DESTRUCTION" OF MATTER, OR MORE CORRECTLY THE "CONSTANT RENEWAL OF ENERGY" — REFERRING TO THE ONE & ONLY "AETHER" OR THE "UNMANIFEST" WHICH FOREVER "MANIFESTS" & "DEMANIFESTS" ITSELF, CYCLICALLY.

THE AETHER EXPLAINS WHICH CAME FIRST... "THE CHICKEN OR THE EGG?" THE AETHER WAS, IS, AND WILL BE... THE CHICKEN & THE EGG SIMULTANEOUSLY CAME AFTER, NEITHER WAS FIRST; ALL PHYSICALITY IS AN EMERGENT PROPERTY, MANIFESTATIONS OF THE ONE, "WORD BECOMES FLESH". BEING

KICKED FROM EDEW WHICH IS ONE IN MACEDONIAN... WE WERE INNOCENT, UNTIL WE WANTED TO FULFILL OUR DESIRES FOR TASTE OF THE FORBIDDEN FRUIT, TO SATISFY OUR SENSES. WE FELL DOWN IN CONSCIOUSNESS WHEN WE WERE PERSUADED BY OUR MIND, TEMPTED TO EAT THE IRRESISTABLE FRUIT FROM THE TREE OF DUALITY — GOD & EVIL, THEY BECAME NAKED, AND COVERED THEIR HUMAN FLESH... THE DUAL WORLD OF EARTH IS HOT & COLD, POSITIVE & NEGATIVE, NIGHT/DAY, SUMMER/WINTER... WHERE PEOPLE ARE BORN AND WHERE PEOPLE DECAY. SO GOD GAVE THEM GARMENTS, AND HE CHASED THEM OUT OF THE WORLD OF ONENESS.

THE AIN ← SOUL ← ANU OR EIN = ONE — ITS UNLIMITED FUEL FOR THE AIN SOPH ← SPIRIT ← ENK-ENLK WHICH IS ENDLESS LIGHT. AIN SOPH ANU ← BODY ← ADAPA IS ILLUMINATION, OR THE ATTRIBUTE OF LIGHT, ELECTRICITY/ILLUMINATION. WE ARE SPIRITS IN A BODY. HELD TOGETHER BY SOUL.



MAGNETISM IS THE ONLY REAL FIELD; ITS THE LOSS OF INERTIA, AND WHAT WE CALL (MAGNETIC ATTRACTION) IS INCREASING INERTIA AND ACCELERATION TOWARDS THE LOWEST PRESSURE ZONE, WHICH PRESENTS TO US THE GEOMETRY OF COUNTERSPACE; THE HYPERBOLOID/HOURGLASS OR DOUBLE CONE SHAPE, IS THE NEGATIVE IMAGE OF A TORUS WHICH SITS PERFECTLY IN A DONUT. <sup>SPACE HAS NO ATTRIBUTES, ITS THE AFTER-EFFECT OF A DIVERGING MAGNETIC FIELD.</sup>

THE GEOMETRY OF SPACE IS THE TOROID OR AN APPLE SHAPE WITH 2 VORTEXES, ONE ON EACH END; ITS THE GYROMAGNETIC PRECESSION OF EVERY MAGNETIC FIELD OF EVERY ATOM. (MAGNETIC REPULSION) IS INVISIBLE, MASSLESS, WEIGHTLESS, SUBSTANCELESS, ENERGY! THE DIELECTRIC FIELD - MANIFESTS AS THE LOSS OF ENERGY OR (3D'S CURVE OF A FORCE VECTOR) IN FULL EXTRAPOLATION. EVERYTHING IS FIELDS - SOURCE OF CREATION. ENERGY = AETHER IN STILLNESS FREQUENCY = AETHER IN MOTION VIBRATION = MATTER

WHAT ARE THE BINARY CONJUGATES OF LIFE? SPIRIT & MATTER; THE COETERNAL PRINCIPLES OF THE UNIVERSE.  $E=MC^2$  ENERGY = MASS x CONSTANT? <sup>WHAT'S THE QUALITATIVE NATURE OF MAGNETISM?</sup>

THERE IS NO SUCH THING AS MAGNETIC ATTRACTION; ITS THE DIELECTRIC FIELD SEEKING ITS PRESSURE MEDIATION TOWARDS A NULL POINT.

THE AETHER HAS 2 OBSERVABLE QUALITIES CALLED DIELECTRICITY AND MAGNETISM. THE SECRETS OF MAGNETISM CAN BE DISCOVERED USING A FERROCELL OR A SUPERCELL INVENTED BY TIM VANDERPELLI & REINVENTED BY KEN WHEELER.

JJ THOMPSON THE DISCOVER OF THE CONCEPT OF THE ELECTRON SAID THAT ELECTRONS ARENT PARTICLES THEY ARE SIMPLY IMPULSES OF DIELECTRIC DISCHARGE. - THE INNER VOLUME OF EVERY ATOM IS MAGNETO-DIELECTRICITY. WHICH ARE 2 AETHER MODALITIES IN DYNAMIC POLARIZATION, AND ALL ATOMS ARE POLARIZED. MAGNETISM IS BOTH VOLUMINOUS & LUMINOUS

ELECTRICITY IS THEREFORE CARRIED BY MAGNETISM, OR THE VOLUME OF THE MAGNETIC FIELD, WHICH IS THE POSTERIOR ATTRIBUTE OF THE LOSS OF INERTIA. RESULTING IN MAGNITUDE, OR DIMENSIONAL FORCE. OHM IS USED TODAY AS THE STANDARD UNIT OF MEASUREMENT FOR ELECTRICAL RESISTANCE WHICH IS MEASURED IN CYCLES PER SECOND; ELECTRICITY IS THE AETHER IN DYNAMIC CIRCULAR POLARIZATION, I.E. AN OSCILLATING PULSE PERTURBATION IN THE MEDIUM (TRANSVERSE WAVES CAUSED BY A DOUBLE AETHER VORTEX CONNECTED BY A MOMENT CENTER, VIA PRESSURE MEDIATION. ELECTRICITY IS REST AGAINST MOTION EVERYTHING IS CAPACITANCE & RESISTANCE..... MAGNETIC PERMEABILITY & DIELECTRIC PERMITTIVITY..... CONSTRUCTIVE & DESTRUCTIVE INTERFERENCE, CENTRIPETAL CONVERGENCE & CENTRIFUGAL DIVERGENCE.

BEFORE NEODYMIUM IRON BORON OR A CHUNK OF SUMERIAN COBALT BECOME MAGNETISED IT HAS A CERTAIN SPECIFIC QUANTITY OF MEASUREMENT SUCH AS WEIGHT WHICH REMAINS UNCHANGED EVEN AFTER IT BECOMES MAGNETISED. THE ONLY CHANGE IS THE QUALITATIVE NATURE WHICH IS THE INVISIBLE, MASSLESS, WEIGHTLESS AND PARTICLE LACKING ENERGY CALLED "THE AETHER" OR "ZERO POINT ENERGY".

"ITS A PULSE-WAVE UNIVERSE" - SANTOS BOVACCI



GODS INVISIBLE QUALITIES ARE SEEN IN NATURE. ✓  
- THAT WHICH IS SEEN WAS MADE FROM THAT WHICH WAS NOT VISIBLE - BIBLE

LIGHT IS A COMPOUNDED AETHER PERTURBATION MODALITY  
ITS THE AETHER IN DYNAMIC CIRCULAR POLARIZATION

MAGNETISM IS THE FULL EXTRAPOLATION OF CENTRIPETAL CONVERGENCE



KEN WHEELER - SAYS THAT MOTHER NATURE IS NOT AN EVIL SCIENTIST WITH A CALCULATOR AND A BAG OF PARTICLES; SHE'S A HILL BILLY CHICK WITH HAIRY ARMPITS, DREADLOCKS, A HEMP SKIRT AND HER FEET IN THE MUD.

"MOTHER NATURE IS "ANANKE" (WHICH MEANS NECESSITATIVELY) THE MOST DIVINE AND THE MOST SIMPLE, DIVINELY SIMPLEX."

STAN TENNEN THE JEWISH SCHOLAR SAYS THAT MOTHER NATURE IS "ELEGANCE & MINIMALISM AT ITS BEST."

THE DIVINE NATURE OF NATURE, IS PURE NAKED, UNADORNED RECURSION! THE FRUIT TREE YIELDING FRUIT WHOSE SEED WAS IN ITSELF. GENESIS 1:11

KEN WHEELER - SAYS THAT ALL BEAUTY IN THE UNIVERSE IS THE MULTIPLICATIVE MANIFESTATION OF THE EXTRINSIC ATTRIBUTE OF THE ABSOLUTE, AND THAT LIGHT ITSELF IS THE CONSUBSTANTIALITY OF SPIRIT & MATTER.

KEN - SAYS THAT MAGNETISM IS THE REASON FOR EVERYTHING THAT IS VISIBLE, AUDIBLE, AND TANGIBLE; THAT WHICH WE CAN SEE, HEAR AND TOUCH. EVERYTHING IN THE UNIVERSE 100% THAT HAS MASS & MAGNITUDE IS DUE TO MAGNETISM ONLY, WHICH IS BOTH VOLUMINOUS & LUMINOUS, & THE EMPTY HOLE @ THE CENTER OF THE MAGNETIC FIELD IS COUNTERSPACE!

DIFFERENT AREAS OF SPACE CAN HAVE DIFFERENT PRESSURES OF ENERGY, NOT NOTICABLE OR MEASURABLE TO US IN OUR EVERY DAY LIVES, BUT INVISIBLE ENERGY FORCES AKA SCALAR WAVES CAN BE DETECTED USING COILS SHIELDED BY FARADAY CAGES. PLANTS ARE SENTIENT!

IN 2000 SEP. 8 @ WALTER RUSSELLS UNIVERSITY OF SCIENCE & PHILOSOPHY, CLEVE BACKSTER REVEALED THAT AFTER POURING A POT OF BOILING WATER FROM THE COFFEE MAKER INTO THE SINK IN HIS LABORATORY HIS PLANTS WHICH WERE ALWAYS CONNECTED TO THE POLYGRAPHS MACHINE IN HIS LAB, REGISTERED A HUGE AND IMMEDIATE SHOCK WHEN HE DID THIS, WHICH HE LATER FOUND ON THE PRINT OUT. HE WAS OBVIOUSLY PUZZLED AS TO WHAT CAUSED THE READINGS & HAD TO THINK CAREFULLY AS TO WHAT HE WAS DOING RIGHT @ THE MOMENT THAT THE SHOCK WAS REGISTERED. WHICH HE TRACED BACK TO THE BOILING WATER, HE SAMPLED THE SINK WITH A SWAB & SAW A COLONY OF BACTERIA IN HIS SINK. THE PLANTS REACTED TO THE DEATH OF BACTERIA WHICH WERE ACROSS THE LABORATORY.

THE IMPORTANCE OF LOVE AS AN ENERGY AND NOT JUST A REGULAR TRANSVERSE WAVE BUT A LONGITUDINAL SCALAR WAVE, IS BY FAR THE MOST SPIRITUAL MESSAGE TO UNDERSTAND. IF YOU STRIKE A TUNING FORK AND HAVE ANOTHER NEAR BY OF SIMILAR PROPORTIONS THE SOUND VIBRATIONS WILL MYSTERIOUSLY "CARRY OVER" TO THE NON VIBRATING FORK AND CAUSE IT TO RESONATE ON ITS OWN. WE EFFECT PLANTS, PEOPLE AND EVERYTHING IN THE UNIVERSE. THE ENTIRE UNIVERSE IS ONE BEING WITH ONE MIND; AND BOTH NON PHYSICAL AETHER & PHYSICAL MATTER, IS ALL PART OF THAT INTERCONNECTED BEING. FRACTALS OF INFINITE CONSCIOUSNESS.

WE LIVE ON A GIANT ATOM, WHICH MAKES US "ADAMS & MADAMES" TO A BIGGER BEING, WHOSE BODY IS DIMENSIONAL & ELEMENTAL AND WHOSE MIND IS INTERDIMENSIONAL AND SPIRITUAL/AETHERIAL! BRAHMA BREATHES LIFE TO EXISTENCE... BRA - THE OS BREATH = SPIRIT. Brahma  
Theos  
God



FROM CAMBRIDGE UNIVERSITY DR. HAL PUTHOFF REMINDS US OF EXPERIMENTS THAT WERE CONDUCTED BEFORE QUANTUM MECHANICS THEORY EVER EXISTED. WHICH WERE DESIGNED TO SEE IF THERE WAS ANY ENERGY IN EMPTY SPACE. IF THESE AREAS ARE EMPTY, NOTHING SHOULD BE THERE, NO ELECTROMAGNETIC FIELDS, NO HEAT, NO ENERGY. IN ORDER TO TEST THIS IDEA IT WAS NECESSARY TO CREATE AN AREA THAT WAS COMPLETELY FREE OF AIR; A VACUUM SHIELDED FROM ALL KNOWN ELECTROMAGNETIC RADIATION FIELDS. THE SHIELDING OF THESE ENERGY FIELDS WAS ACCOMPLISHED BY USING WHAT IS KNOWN AS A FARADAY CAGE WHICH IS LINED WITH LEAD. THE AIRLESS VACUUM WAS THEN COOLED DOWN TO ABSOLUTE ZERO, THE TEMPERATURE WHERE ALL MATTER SHOULD STOP VIBRATING AND THUS PRODUCE NO HEAT. THESE EXPERIMENTS PROVE THAT INSTEAD OF AN ABSENCE OF ENERGY THERE WAS A TREMENDOUS AMOUNT OF ZERO POINT ENERGY IN THE VACUUM. A SEETHING CALDRON OF NON MATERIAL ENERGY IN VERY HIGH MAGNITUDES.

WALTER RUSSEL - IN "THE SECRET OF LIGHT" SAYS THAT WE CAN TAKE A SINGLE WIRE AND BEND IT 90° AND BEGIN ROTATING IT; AT SLOW SPEEDS WE SEE THE WIRE, AT FAST SPEEDS WE ONLY SEE THE APPEARANCE OF A SOLID DISK. SOLID MATTER IS ULTIMATELY COMPOSED OF NON SOLID ENERGIES VIBRATING AT A CERTAIN FREQUENCY.

THE THEORY OF RELATIVITY IS NOT VALID BECAUSE IT STATES THAT LIGHT IS THE FASTEST SPEED AS A PHOTON PARTICLE, BUT WHEN LIGHT ENTERS A CUP OF WATER IT SLOWS DOWN THEN WHEN IT EXITS THE GLASS, IT SPEEDS UP AGAIN, BREAKING THE LAW OF CONSERVATION OF ENERGY. LIGHT THEREFORE IS NOT A PARTICLE.



A WAVE IS NOT WHAT SOMETHING IS, RATHER WHAT SOMETHING DOES; LIGHT IS THE AETHER IN MOTION MAX RATE OF PROP.

DR. PUTHOFF SAYS Q.M.T CANT EXPLAIN WHY AN ELECTRON DOESNT RADIATE AWAY ALL OF ITS ENERGY, ITS (STRANGE BEHAVIOR) THEY SAY.. BEING A CHARGED PARTICLE, AND RADIATING OUT THE CHARGE IT SHOULD RUN OUT. IT WOULD APPEAR TO BE A KIN TO A TINY PERPETUAL MOTION MACHINE.



THE AETHER FLUID IS IN CONSTANT VIBRATIONAL MOTION FLOWING THROUGHOUT THE ENTIRE UNIVERSE AND ALL OBJECTS, CREATING AND RECREATING EVERYSECOND. JUST AS A NEVER ENDING CANDLE FLAME IS CONSTANTLY ABSORBING NEW OXYGEN AND RADIATING NEW HEAT AND NEW LIGHT BUT STILL CONTINUES TO EXIST AS A MEASURABLE UNIT, A SINGLE FLAME.

ONCE WE ACCEPT THIS ENERGIES EXISTENCE MANY PROBLEMS IN QUANTUM MECHANICS WILL CLEAR UP. THE VERY EXISTENCE OF ATOMS AS NOW SEEN IN QUANTUM MECHANICS CANT BE ADEQUATELY EXPLAINED WITH OUR CURRENT EXISTING MODELS.

THE MAINSTREAM QUANTUM MECHANICS THEORY DOES NOT UNDERSTAND WHY AN ELECTRON DOES NOT CRASH INTO THE NUCLEUS AS A SATELLITE WILL EVENTUALLY DO IN EARTHS ORBIT, SO TO SPEAK; AFTER IT HAS RADIATED ALL OF ITS ENERGY....

THEIR ANSWER IS THAT THE PROTON & NEUTRON IS A CLOSED SYSTEM, WHERE ENERGY IS RADIATED OUT BUT NO NEW ENERGY CAN COME IN. - BUT EVERY PHYSICIST KNOWS THAT ENERGY CANT BE CREATED NOR CAN IT BE DESTROYED.

THE ELECTRON - ISNT A PARTICLE, ITS AN IMPULSE FROM THE CENTER, THAT IS CONSTANTLY DRAWING ENERGY FROM THE AETHER, SURROUNDING THE CENTER AND RETURNING TO THE CENTER, ITS AN OPEN SYSTEM.



THE VISIBLE PART OF THE ELECTRO MAGNETIC SPECTRUM THAT WE CAN SEE AS PERCEIVABLE ILLUMINATION IS THE AETHER IN DYNAMIC CIRCULAR POLARIZATION.

A RECIPROCATING PRECESSIONAL HYPERBOLOID.

THE SPEED OF LIGHT IS THE MAXIMUM RATE OF CURLAGE OF THE MEDIUM; MAX "HYSTERESIS" OF THE AETHER

THE PLANE OF INERTIA

- STATIONARY
- TELLURIC } LMD WAVES
- TUNAL

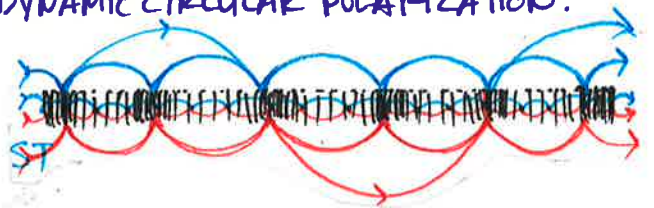
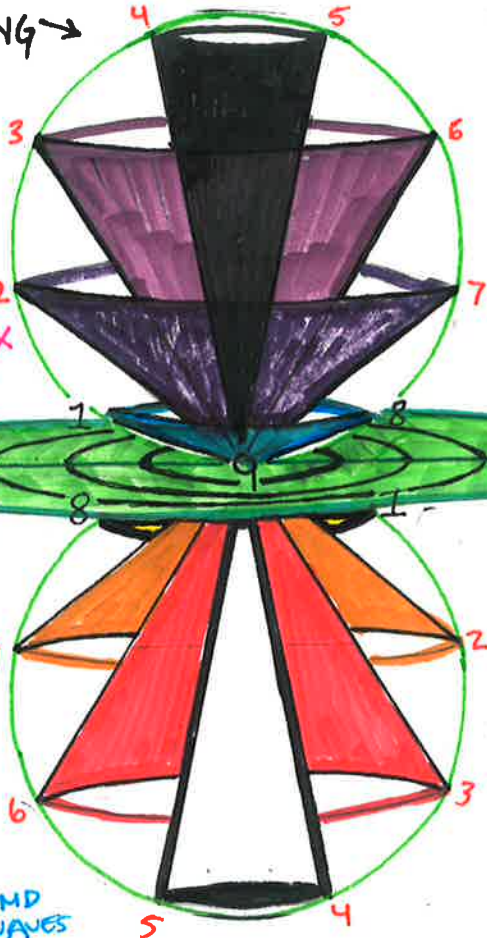

'LONGITUDINAL MAGNETO-DIELECTRICITY' L.M.D - IS COMPRESSIONS AND RAREFACTIONS OF THE MEDIUM.

☐ ← COMPRESSION ☐ ← RAREFACTION  
 ← → "SCALAR WAVE"  
 - PLANAR WAVES -

'TRANSVERSE ELECTRO-MAGNETISM' T.E.M - IS A VERTICAL (SPIRAL) OSCILLATING PULSE PERTURBATION WITH ELECTROMAGNETIC CONSTITUENTS WHICH PRODUCES BOTH VOLUMINOUS & LUMINOUS PHENOMENA. - IT IS EMF PHASE ONLY WHICH IS MEASURED IN CYCLES PER SECOND.



NIKOLA TESLA DISLIKED (T.E.M) HERTZIAN WAVE TECHNOLOGY HE WAS A FAN OF (L.M.D) "SCALAR WAVE TECHNOLOGY", NON-SPATIAL, NON-OSCILLATING "INSTANTANEOUS ACTION AT A DISTANCE", NO SIGNAL ATTENUATION AND REQUIRES LESS ENERGY FOR TRANSMISSION OF POWER I.E. (TELE FORCE)

INSTANT TRANSMISSION & INSTANT RECEPTION.

NULL PHASE EMISSION, THERE ARE NO TRANSVERSE COMPONENTS ITS A RADIAL PULSE PERTURBATION AND HAS NO HYSTERESIS OR RATE OF INDUCTION, JUST HORIZONTAL RAREFACTIONS AND COMPRESSIONS MEASURED IN VOLTS PER SECOND.

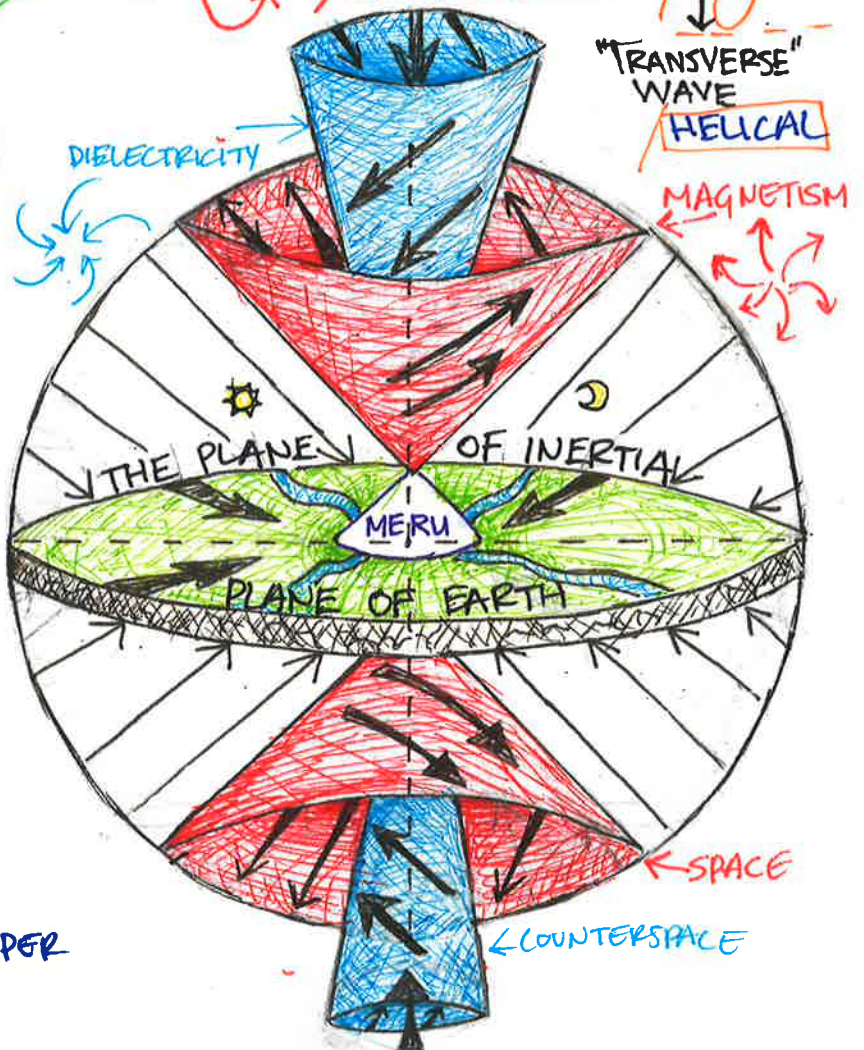



1, 1, 2, 3, 5, 8, 13, 21, 34, 55

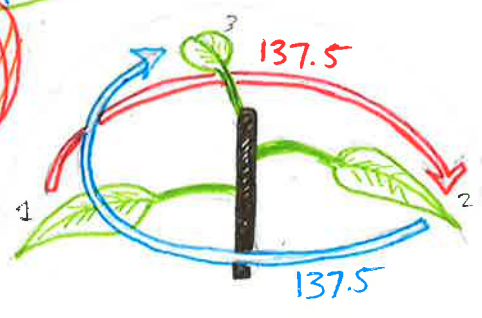
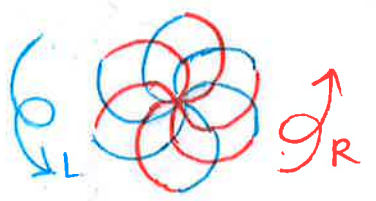
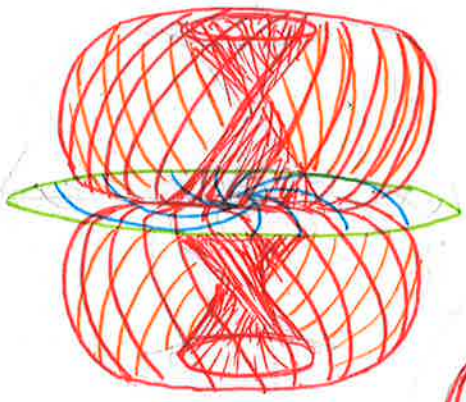
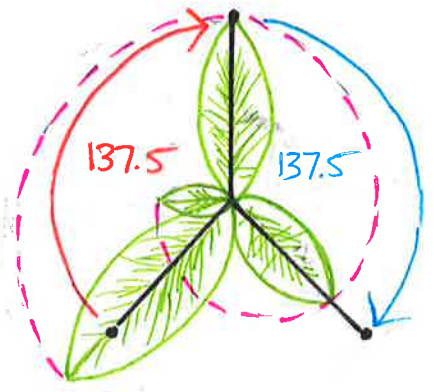
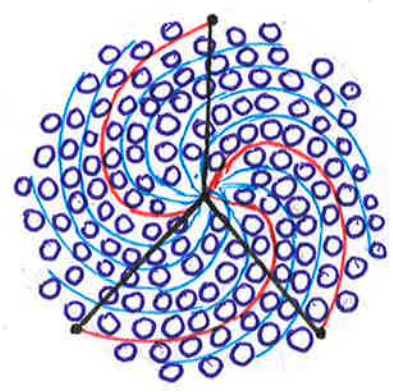
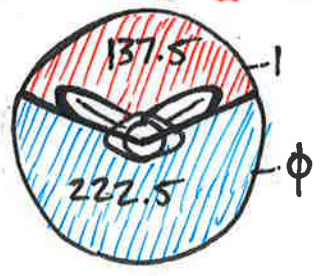
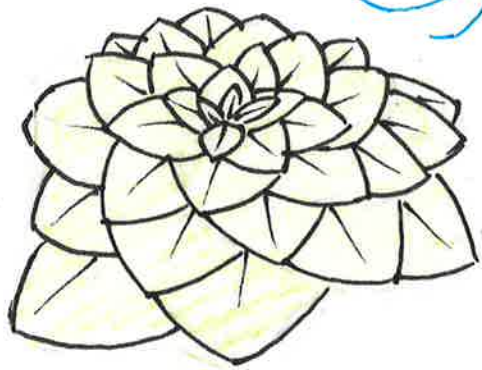
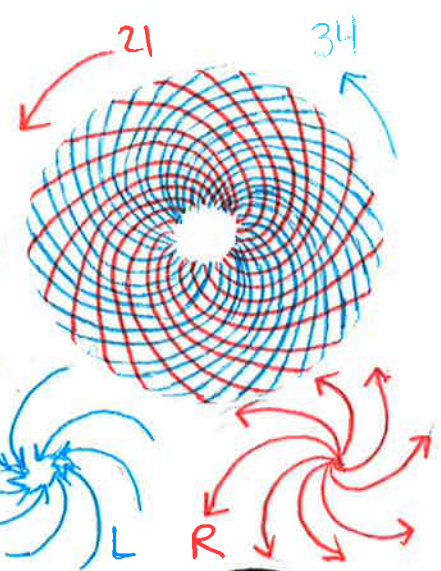
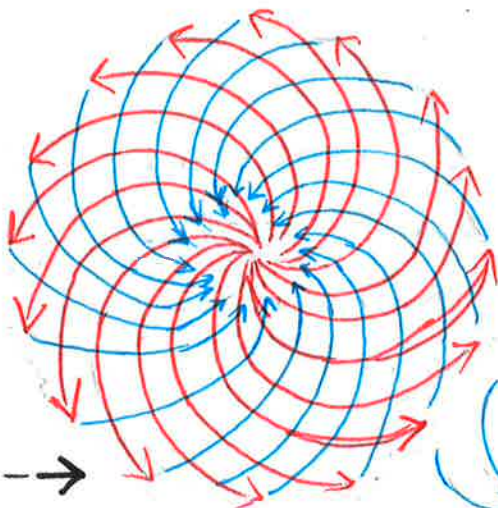
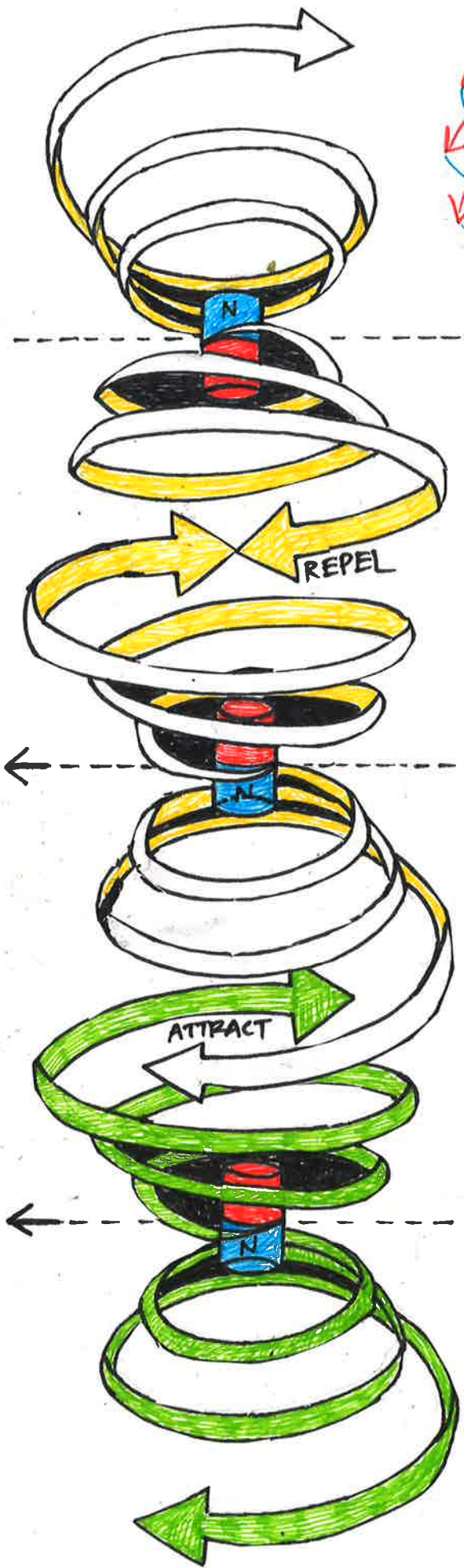



## "WE ARE 'IN-PHI-NITE'"

THE HEXAGRAM AS WELL AS THE YIN & YANG ARE REPRESENTATIONS OF THE HERMETIC LAWS OF PHYSICS AND ENCODES THE TOROIDAL DYNAMICS WHICH GENERATES ALL BALANCE MOVEMENT AND LIFE IN THE UNIVERSE.

THIS IS AN ETERNAL ARCHETYPAL PATTERN WHICH EXPLAINS CREATION THROUGH LANGUAGE OF LIGHT. ALL PHILOSOPHIES AND SCIENTIFIC DISCOVERIES MERGE AS AN INTERCONNECTED SYSTEM OF SCIENCE IN THE LIGHT OF SACRED GEOMETRY AND ANCIENT HERMETIC AXIOMS. THIS IS THE NATURE OF THE UNIVERSE AND NATURE ITSELF. THE SCIENCE OF TIME SPACE AND LIGHT, THE CAUSE OF LIGHT, LIFE AND CONSCIOUSNESS EVOLUTION.

THERE IS ONLY ONE FORCE THAT MOVES THROUGH ALL, WE ARE EXPRESSIONS OF THIS UNIVERSAL FORCE. THE YIN AND YANG IS A CIRCLE WITH 2 TEAR DROP SHAPED SWIRLS. THE BLACK SWIRL (YIN) IS ASSOCIATED WITH FEMININITY AND RECEPTIVITY - THE MOON. THE WHITE SWIRL IS -THE SUN- AND ASSOCIATED WITH GROWTH AND PASSION. **THE SYMBOL REPRESENTS THE BELIEF THAT EVERYTHING IN THE UNIVERSE CONSISTS OF THESE 2 SYMBIOTIC FORCES.**

DIELECTRICITY & MAGNETISM, 2 AETHER MODALITIES. WHEN WE LEARN ABOUT THE AETHER WE BEGIN TO UNCOVER HOW THINGS COME TO BE, WHY THINGS EXIST AS THEY DO AND WHAT THEY REALLY ARE. WE CAN UNDERSTAND WHY PERFECT PROPORTIONALITY EXISTS, WHY THE HARMONY OF LIFE AND NATURE IS IMPORTANT, AND HOW SPIRIT AND MATTER CAN WEAVE AMONGST EACH OTHER TO CREATE LIFE.

**THE INNER VOLUME OF EVERY MOM IS MAGNETO-DIELECTRICITY & IS POLARIZED!**

**IF YOU CUT A MAGNET IN HALF A MILLION TIMES YOU'LL END UP WITH A MILLION MINIMATURE MAGNETS, THEREFORE WE ARE DEALING WITH PRESSURE MEDIATION, 2 POLES, SEPERATED BY A PLANE OF INERTIA, OR A BLOCH WALL. (There are no poles) THERE IS ONLY GYRO MAGNETIC PRECESSION DUE TO THE COUNTER ROTATING FIELDS OF MAGNETISM. RADIATION IS THE CENTRIFUGAL DIVERGING FORCE VECTOR, ITS WHAT CAUSES 2 MAGNETS TO REPEL EACH OTHER. WHAT WE CALL "MAGNETIC ATTRACTION" IS ACTUALLY DUE TO CENTRIPETAL CONVERGENCE THE DIELECTRIC FIELD ACCELERATING TOWARDS THE LOWEST PRESSURE ZONE, COUNTERSPACE SEEKS REST, MAGNETISM IS MOTION, CREATING MAGNITUDE.**

**Manly P. Hall** - Mainly Known for his book 'The SECRET Teachings of All Ages', was a mystic, astrologer and Author. He studied Ancient Knowledge to Discover Hidden Secrets. His works are Enlightening, and they encourage us to work towards uniting with our HIGHER SELVES.

"PHILOSOPHY REVEALS TO MAN HIS KINSHIP WITH THE ALL. IT SHOWS HIM THAT HE IS A BROTHER TO THE SUNS WHICH DOT THE FIRMAMENT; IT LIFTS HIM FROM A TAXPAYER ON A WHIRLING ATOM TO A CITIZEN OF THE COSMOS, IT TEACHES HIM THAT WHILE PHYSICALLY BOUND TO EARTH, THERE IS NEVERTHELESS WITHIN HIM A SPIRITUAL POWER, A DIVINE SELF, THROUGH WHICH HE IS ONE WITH THE SYMPHONY OF THE WHOLE."

"HUMANS ARE CAUGHT IN A PREDICAMENT WHEREIN THE LIMITATIONS IMPOSED BY PHYSICAL EXISTENCE ARE COMBINED WITH TRIPLE IGNORANCE; IGNORANCE OF OUR ORIGINS, OF OUR TRUE NATURE AND OF OUR ULTIMATE DESTINY."

"MAN IS NOT THE INSIGNIFICANT CREATURE THAT HE APPEARS TO BE; HIS PHYSICAL BODY IS NOT THE TRUE MEASURE OF HIS REAL SELF. THE INVISIBLE NATURE OF MAN IS AS VAST AS HIS COMPREHENSION AND AS MEASURELESS AS HIS THOUGHTS. THE FINGERS OF HIS MIND REACH OUT AND GRASP THE STARS; HIS SPIRIT MINGLES WITH THE THROBBING LIFE OF THE COSMOS ITSELF."

"THROUGH IGNORANCE MAN FALLS; THROUGH WISDOM, MAN REDEEMS HIMSELF."

"BOTH GOD AND MAN HAVE A TWOFOLD CONSTITUTION, OF WHICH THE SUPERIOR PART IS INVISIBLE AND THE INFERIOR IS VISIBLE."

M.P.H  
"THE ANCIENTS DID NOT BELIEVE THAT SPIRITUALITY MADE MEN EITHER RIGHTEOUS OR PARNOURAL BUT PATH THE RIGHTEOUSNESS AND PARNOURALTY MADE MEN SPIRITUAL."



THE LOWEST EXTRAPOLATION OF PRESSURE MEDIATION APPLIES TO GROWTH, BASED ON THE ROTATION RATE OF THE COUNTER ROTATING FIELDS OF MAGNETISM.

THE "GOLDEN RATIO" - SOMETIMES CALLED THE "DIVINE PROPORTION", OR SIMPLY THE "PHI RATIO", IS FOUND ALL OVER NATURE FROM SMALLER THAN NANO TO GALAXIES. THEREFORE WHAT MAKES THIS PROPORTION SO DIVINE IS ITS FREQUENCY IN THE NATURAL WORLD, FROM MICRO TO MACRO THROUGHOUT THE COSMOS. THE # OF PEDALS ON A FLOWER FOR INSTANCE WILL OFTEN BE A FIBONACCI #, WHICH IS FOUND IN THE GOLDEN RECTANGLE, WHICH REVEALS TO US THE GOLDEN ANGLE 137.5 DEGREES. PLANTS USE THIS ANGLE TO DISTRIBUTE THEIR LEAVES FOR MAXIMUM EXPOSURE TO SUN AND RAIN, INCREASING THE EFFICIENCY OF PHOTOSYNTHESIS, GENERATING BETTER MOISTURE FOR ROOTS, AND FACILITATING INSECT POLLINATION. THE PROGRESSION PROPORTION OF FIBONACCI #'S ARE ALSO IMPORTANT AND SUITABLE TO DESCRIBE THE (ORGAN GROWTH) IN THE HUMAN BODY, BECAUSE THEY HAVE PROPERTIES OF AUTO SIMILARITY, & GNOMONIC GROWTH, WHICH MEANS ONLY SIZE CHANGES WHILE THE SHAPE REMAINS CONSTANT.

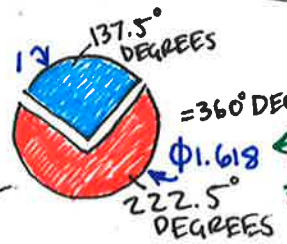
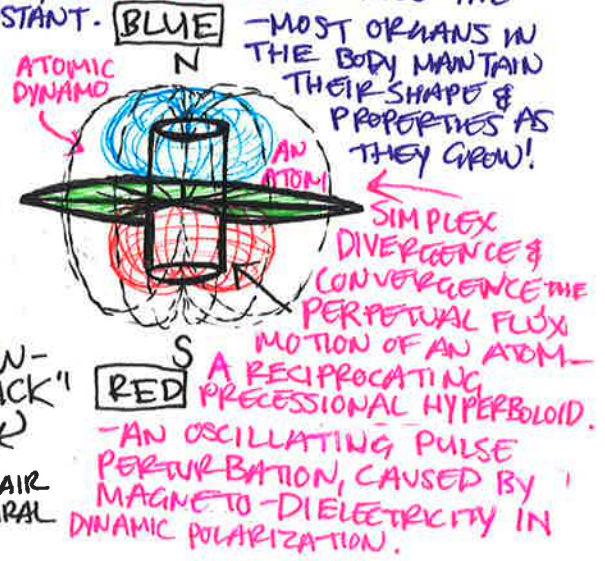
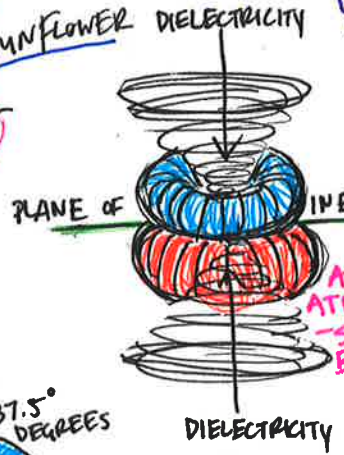
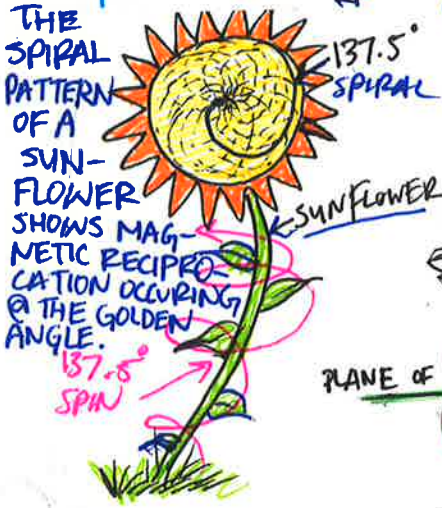
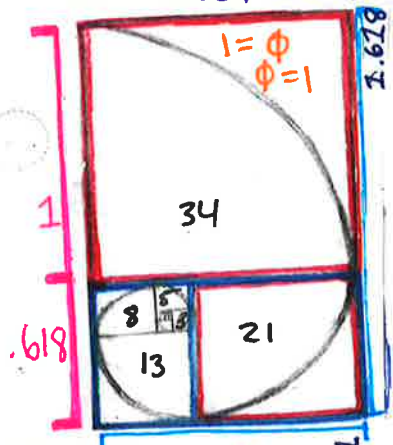

IF THE ENTIRE CIRCLES CIRCUMFERENCE WAS 1, THE BOTTOM, BIGGER SECTION WOULD BE .618.

← WHEN THE CIRCUMFERENCE OF A 360° CIRCLE IS CUT INTO 2 SECTIONS USING THE GOLDEN RATIO; 2 ARC LENGTHS ARE REVEALED.

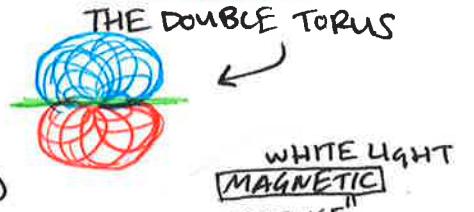

137.5° IS THE GOLDEN ANGLE

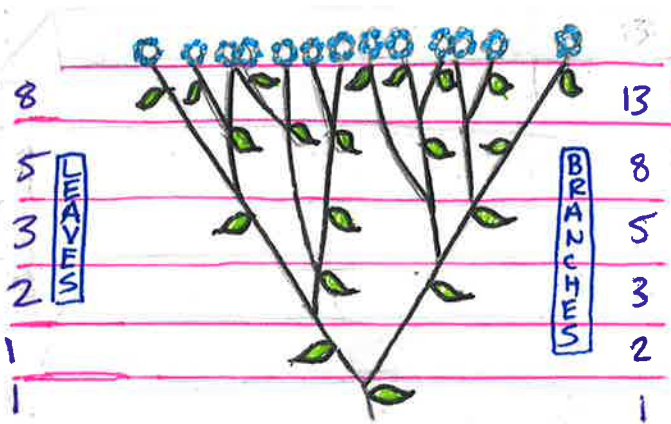

THE FIBONACCI SEQUENCE NUMBERS ARE ALSO CALLED (GROWTH NUMBERS) AS THEY APPEAR IN MANY THINGS, THEY ARE BASED ON THE PRINCIPLE OF "GNOMONIC GROWTH", REFERRED TO BY THE GREEKS WE CAN SEE THESE NUMBERS ON THE LEAVES AND BRANCHES OF A FIELD DAISY.

"Leonardo Fillius-Bonacci"  
-son of Guglielmo Bonacci.  
LEONARD, PISANO & -OF PISA





HOW ATOMS WORK  
(FULL MAGNETIC FIELD SPECTRUM)

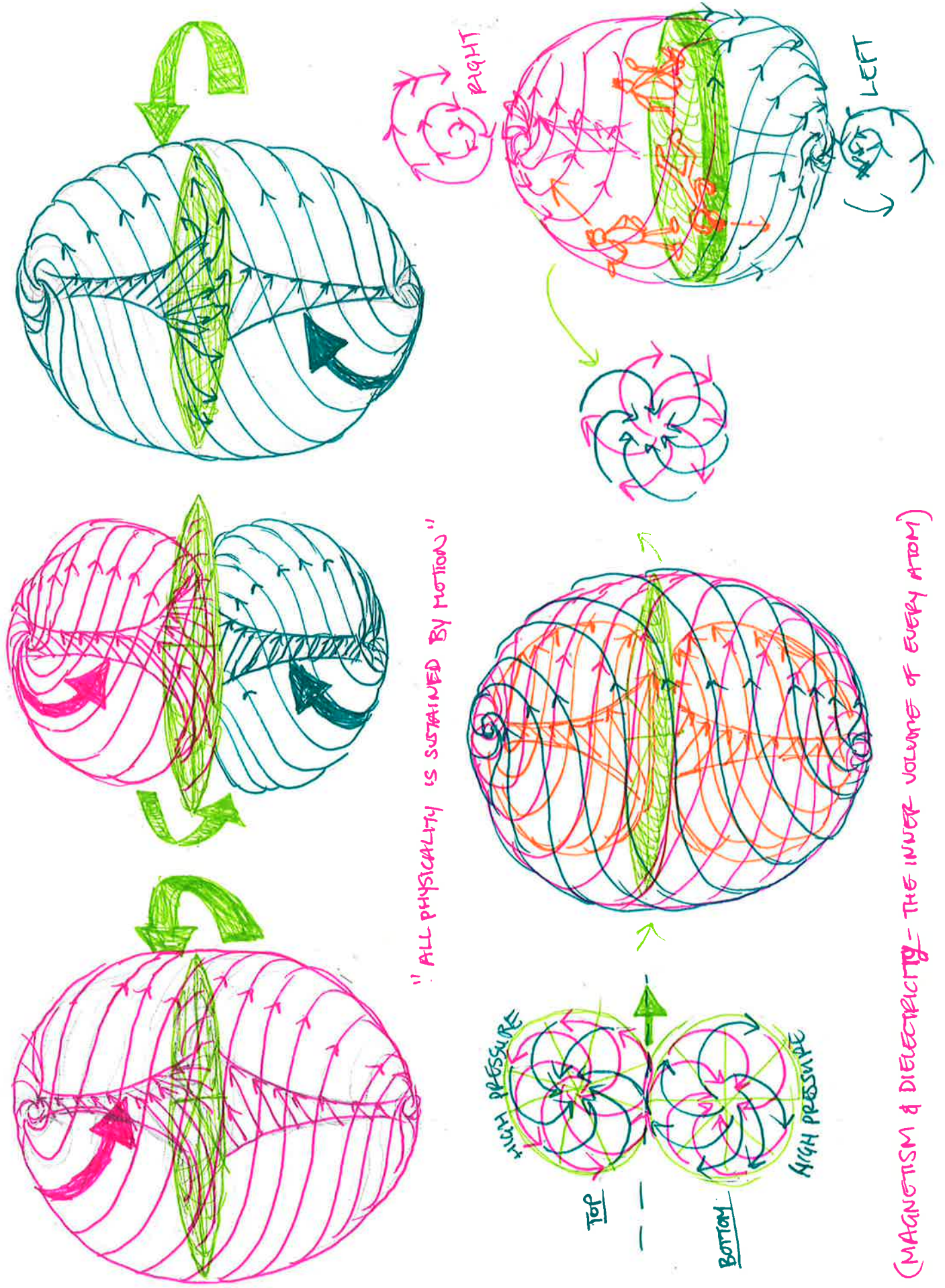

" ALL PHYSICALITY IS SUSTAINED BY MOTION "

(MAGNETISM & DIELECTRICITY - THE INNER VOLUME OF EVERY ATOM)



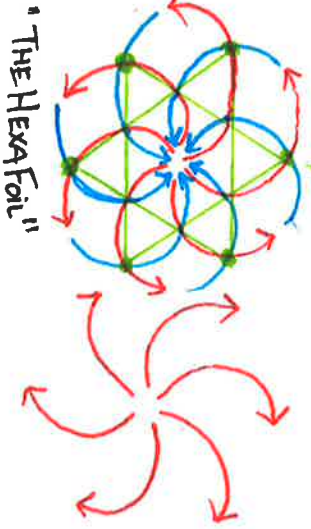
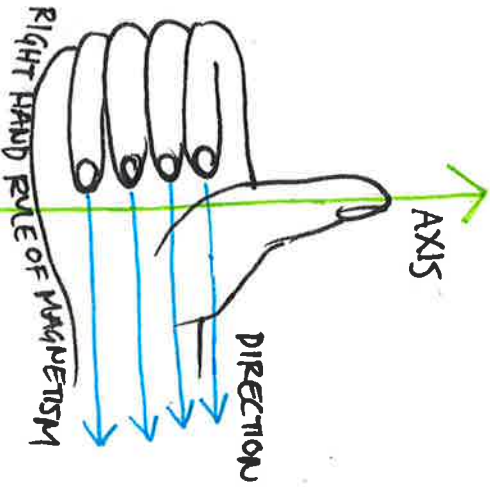
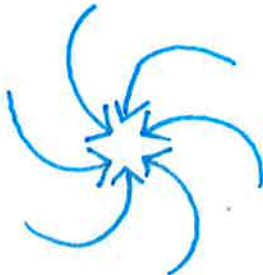
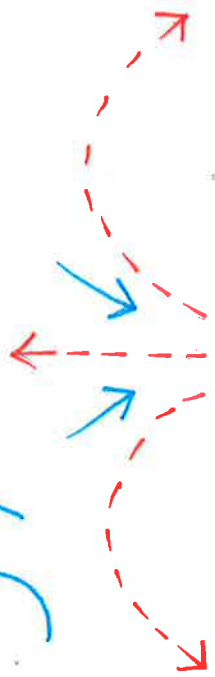
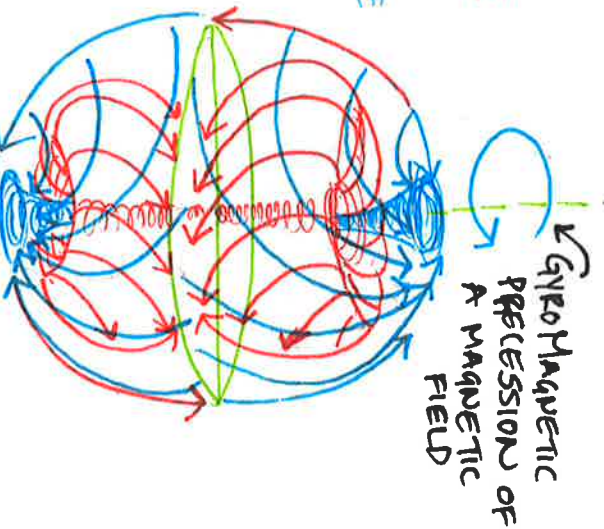
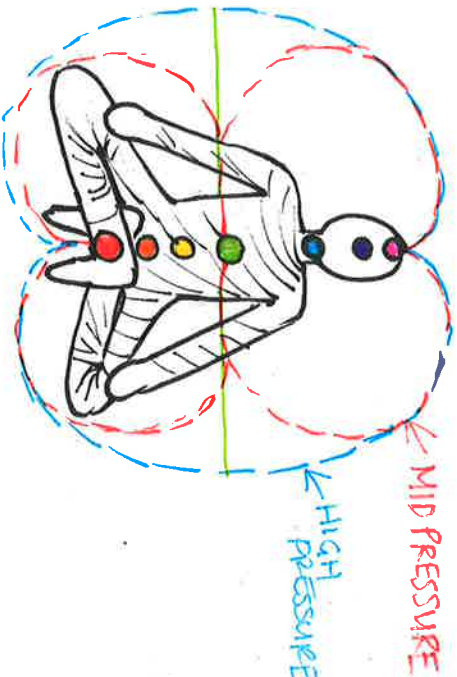
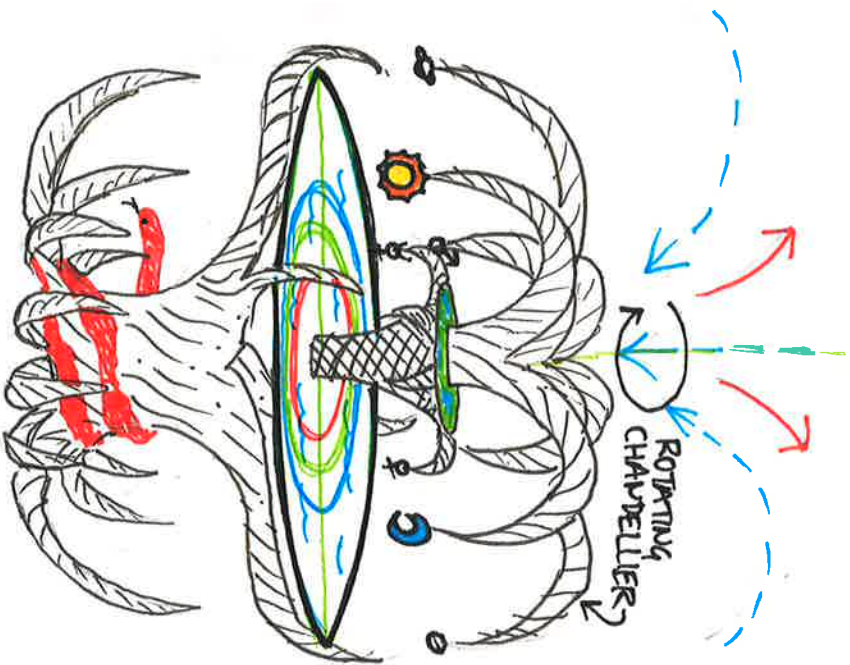

HOLOGRAPHIC SOURCE POINT SELF-SIMILARITY  
 Every point within the subject is a replica of the entire whole. K.W.

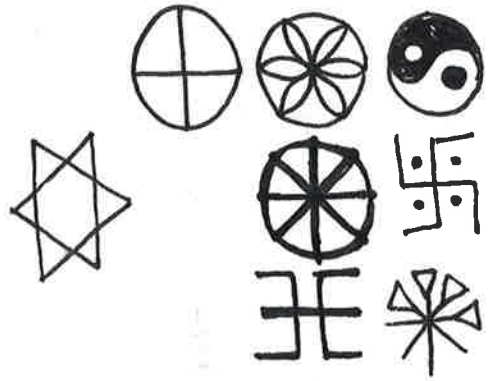



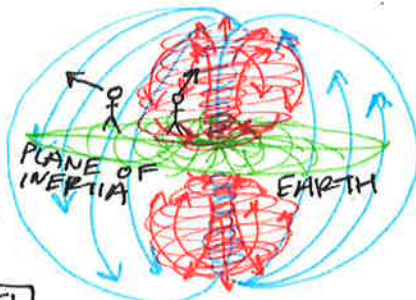
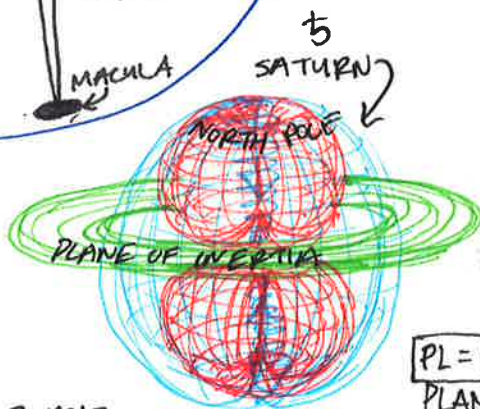
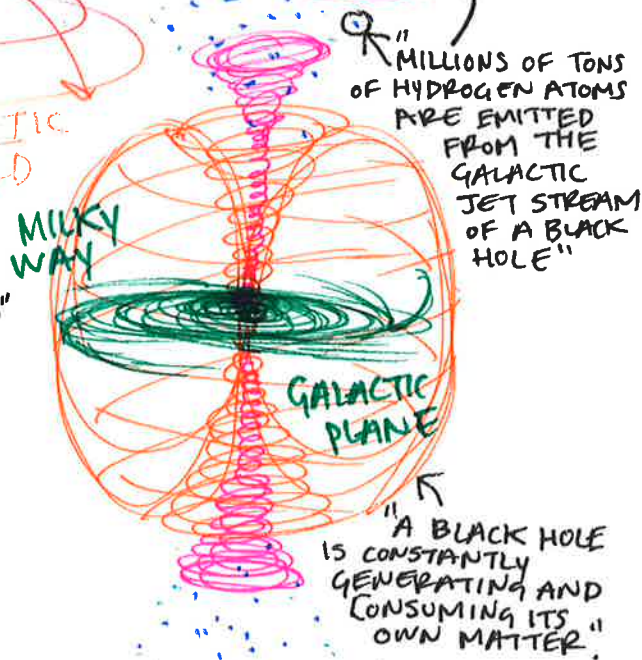
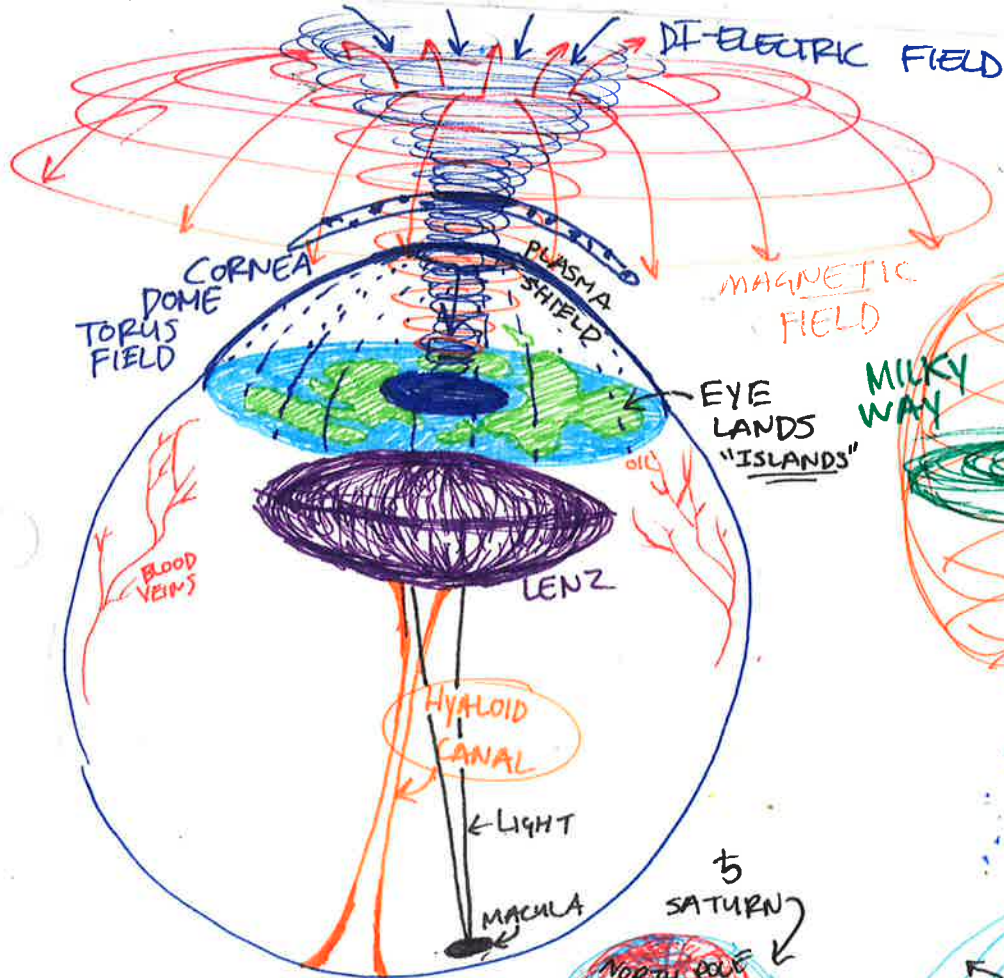
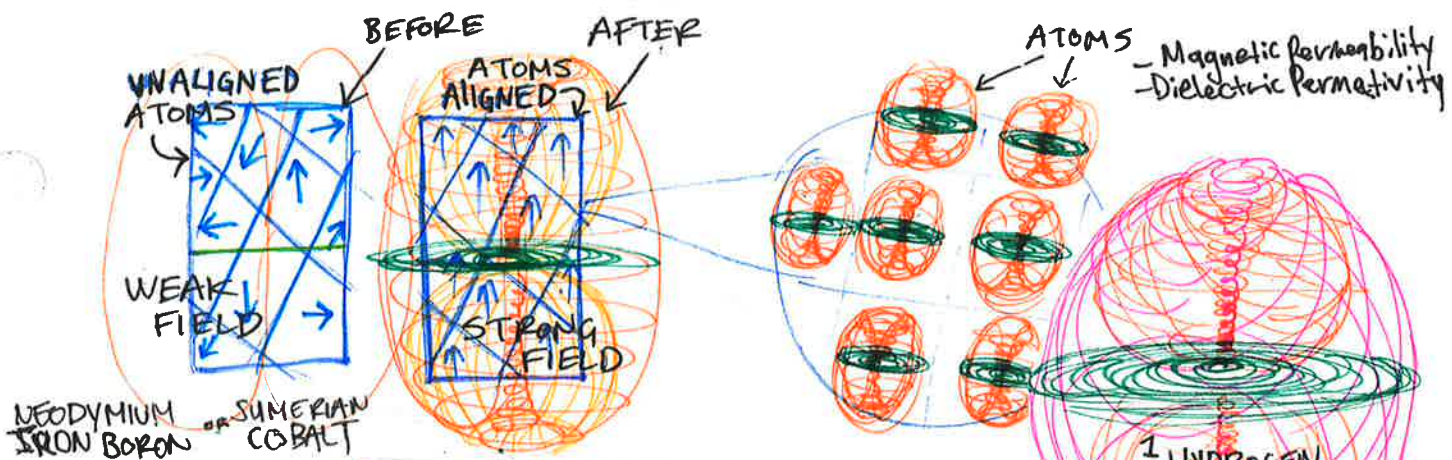

KEN WHEELER  
 "ALL ATOMS ARE HYPERDIMENSIONAL STAR-GATES."

- JUST LIKE THE BLACK HOLE AT THE CENTER OF A GALAXY - AS ABOVE, SO BELOW!

PL = FL

PLANO = FLAT in SPANISH

- Plane Plate Plateau Platypus Flipper Floor
- PLank PLayground PLaza PLAque Fleet FLap
- PLYwood PLatform PLaya PLat
- PLatter PLancha PLaca PLantation
- Planet PLaid PLatonic



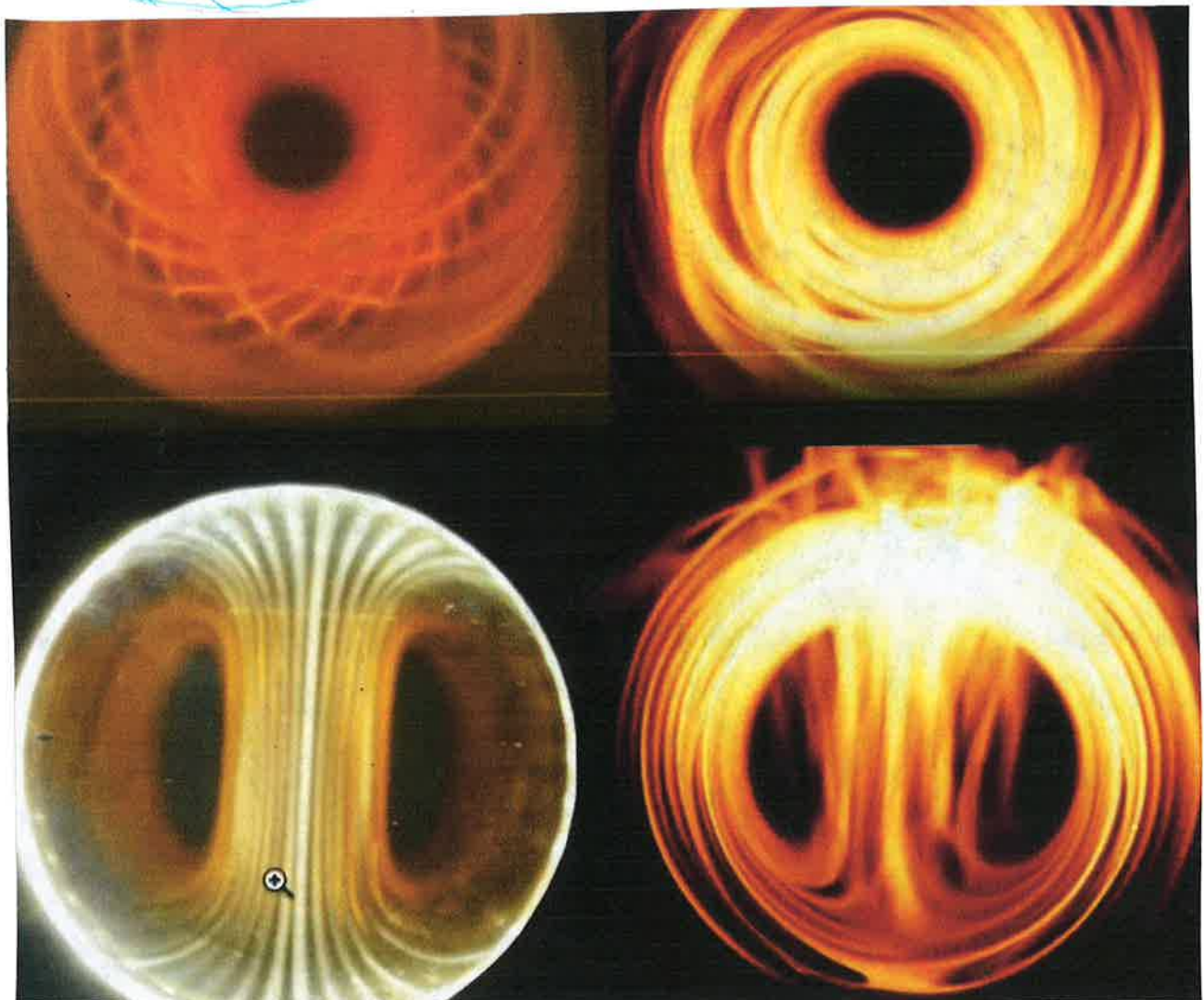
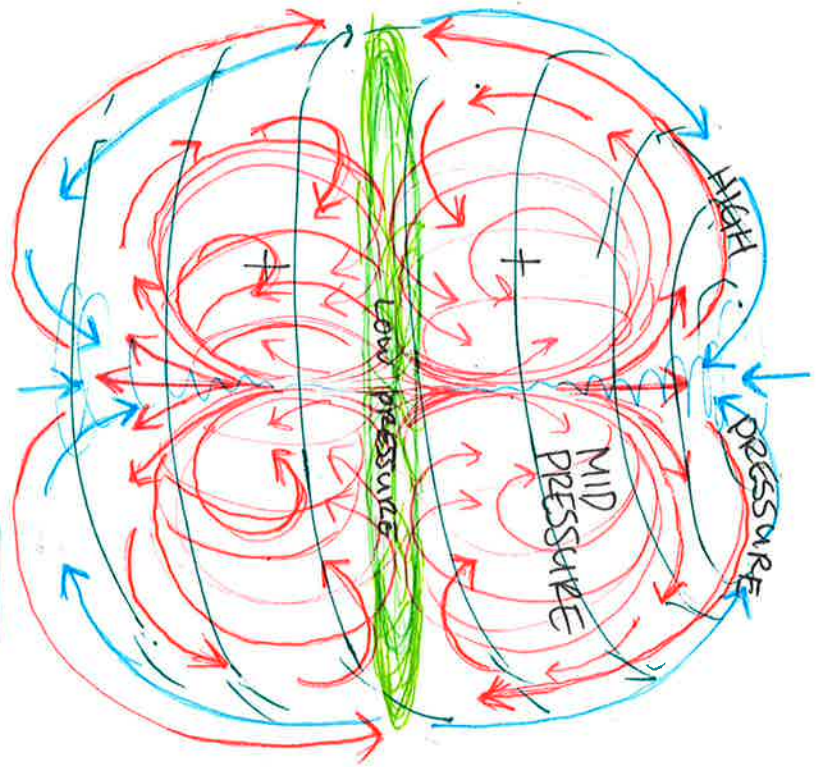
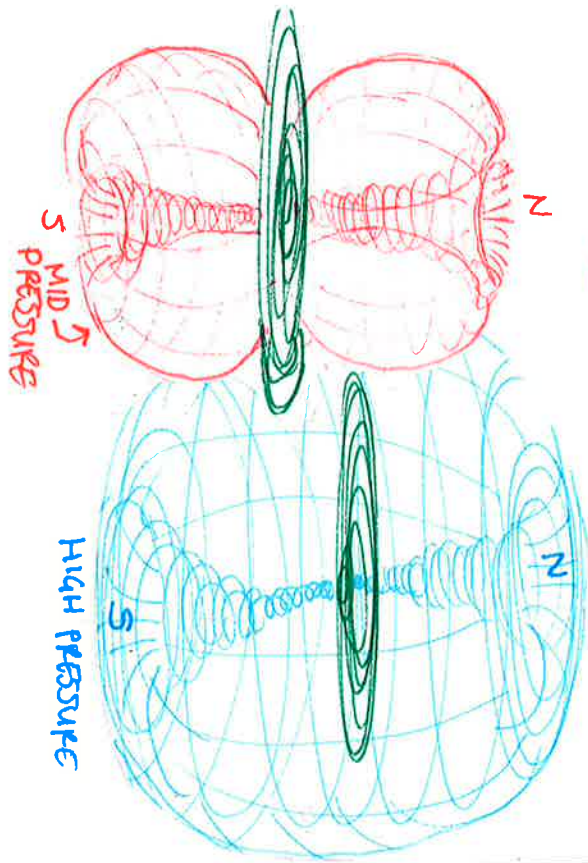



**ALCHEMY** IS THE ANCIENT BRANCH OF NATURAL PHILOSOPHY, ITS A PHILOSOPHICAL AND PROTO-SCIENTIFIC TRADITION THAT CHINA, INDIA, EGYPT, MEXICO AND EUROPE HISTORICALLY PRACTICED. IT IS THE FOUNDATION OF ALL WORLD RELIGIONS, AS A CONCEPT OF LINKING THE PHYSICAL AND SPIRITUAL FORCES OF NATURE INTO ONE. BODY AND SOUL, HEAVEN AND EARTH, PHYSICS AND METAPHYSICS.

**IN ALCHEMY** THE TERM CHRYSOPEIA MEANS "GOLD MAKING" REFERRING TO THE ARTIFICIAL PRODUCTION OF GOLD, MOST COMMONLY BY THE ALLEGED TRANSMUTATION OF BASE METALS SUCH AS LEAD. A SIMILAR TERM IS ARGYROPEIA "SILVER MAKING". THE MAKING OF GOLD AND SILVER IS ONE OF THE DEFINING AMBITIONS OF ALCHEMY, 'MAGNUM OPUS' IS LATIN FOR 'THE GREAT WORK' BY WORKING WITH THE PRIMA MATERIA AND CREATING THE PHILOSOPHERS STONE.

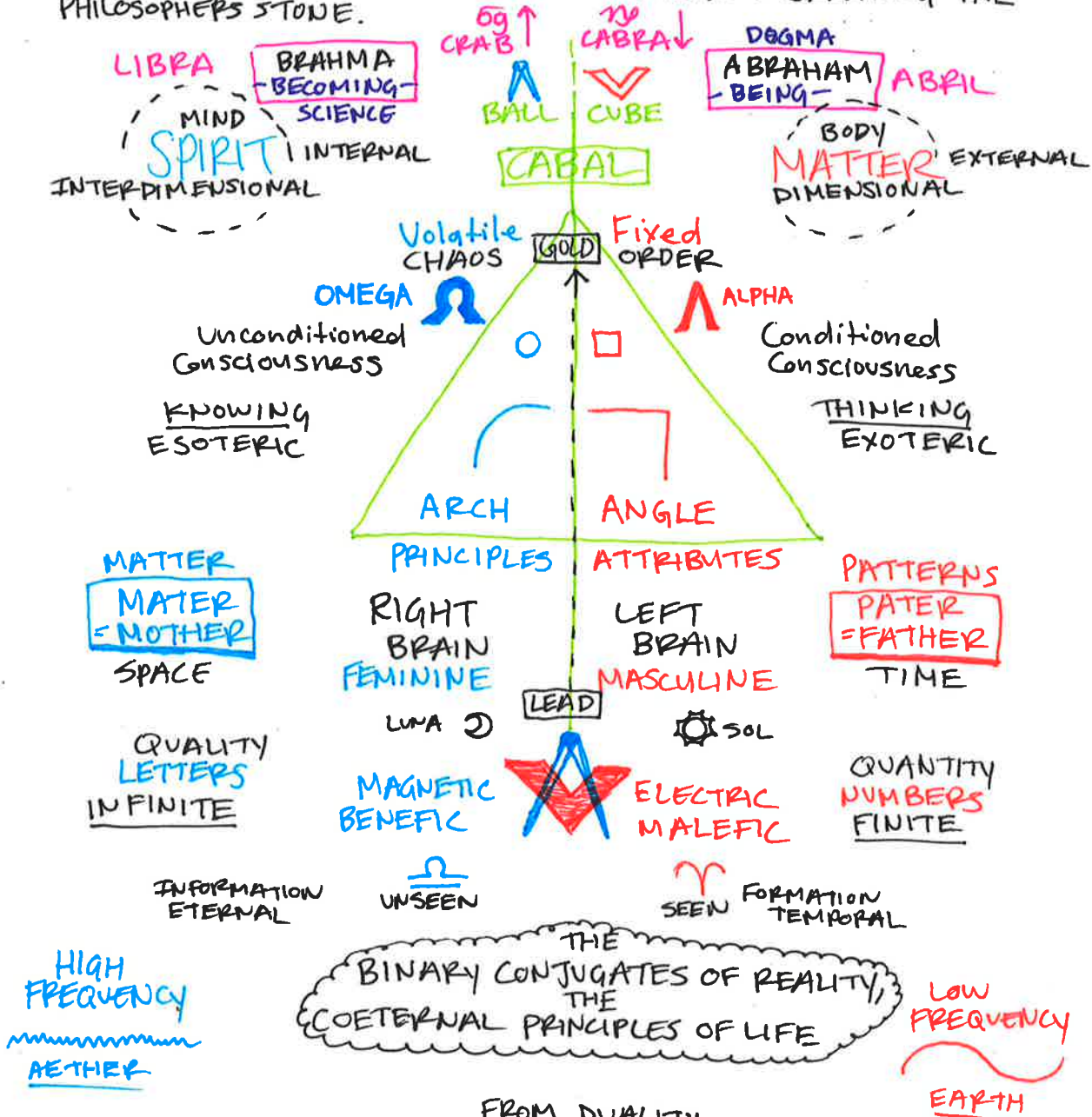

"OWN THE SUBCONSCIOUS MORE & MORE."  
 "Know it by being it, your full potential."  
 "UNFOLD YOUR ENLIGHTENMENT."  
 "THE UNIFIED FIELD IS OUR FRIEND."  
 "QUALITY EXPANDS."

**KEN WHEELER** THE DAO... THE BRAHMAN... THE UNMANIFEST...  
 "MOTHER NATURE IS DIVINE AND SIMPLE, ELEGANT AND MINIMAL."  
 ENERGY, INTELLIGENCE, LOVE, BLISS, FULLNESS, INFINITE CREATIVITY  
 NIRVANA, PEACE, POWER, PURE UNBOUNDED CONSCIOUSNESS



"ALL IS SACRED, NOTHING IS WASTED"-DBBD

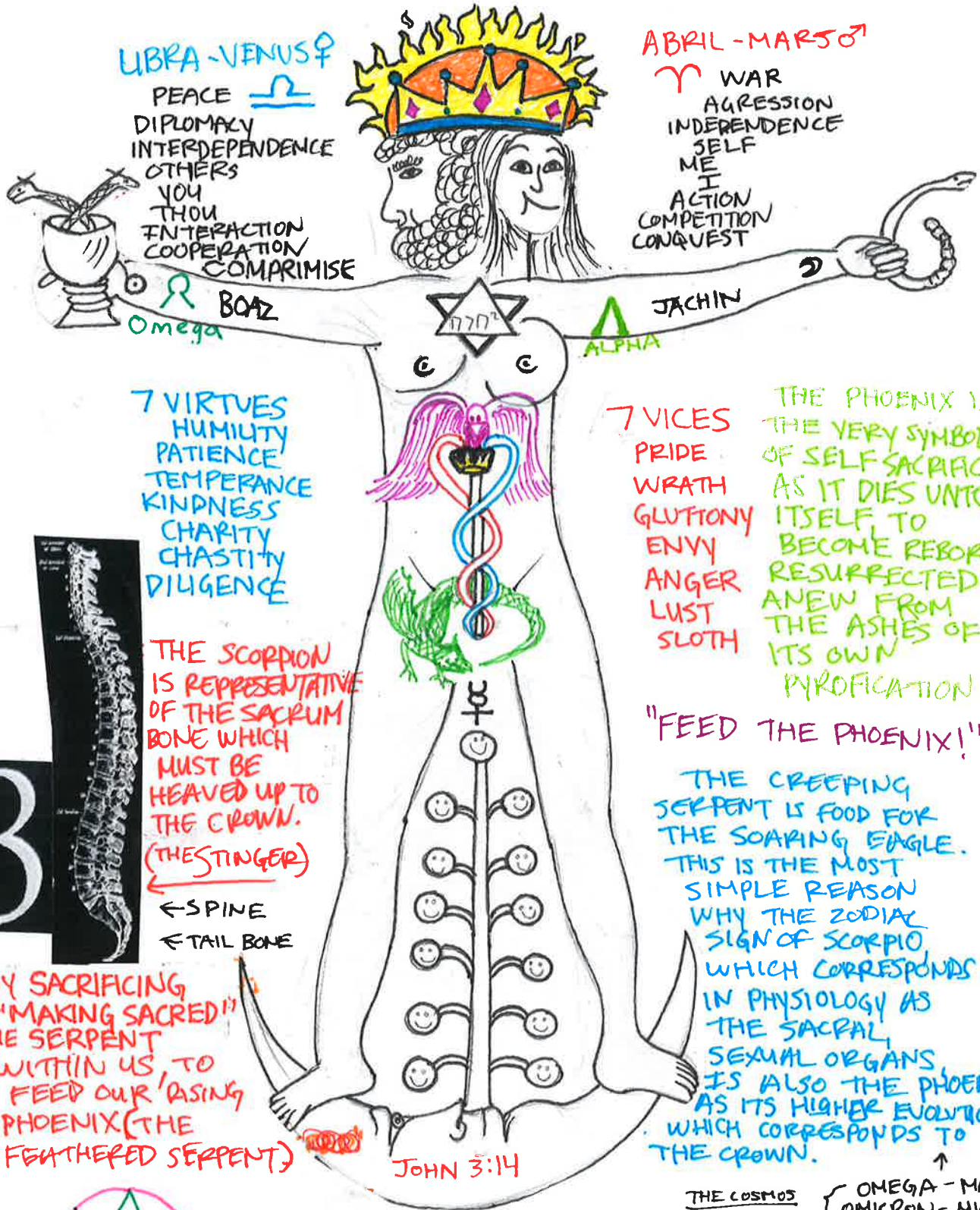

33



"HEALTHY BALANCED HUMAN WITH INTEGRITY"

∞

WITHIN = HI TWIN

**THE COSMOS**  
 { OMEGA - Macro  
 MICRON - Micro  
 ↓  
 EQUI-LIBRA-TE  
 CO-LIBRA-TE  
 LIB-E-RATE  
 (COLLABORATE)



**ACTS 26:18** OPEN THE EYES OF OTHERS AND TURN THEM FROM DARKNESS TO LIGHT, AND FROM THE POWER OF SATAN TO GOD.

Sun	....	Gold	☉
Mon	....	Silver	☾
Tue	....	Iron	♁
Wed	....	Mercury	☿
Thu	....	Tin	♃
Fri	....	Copper	♁
Sat	....	Lead	♄

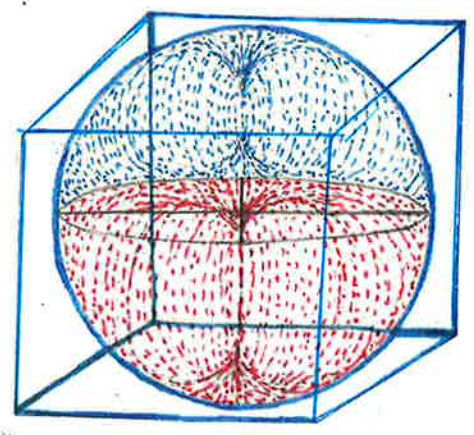
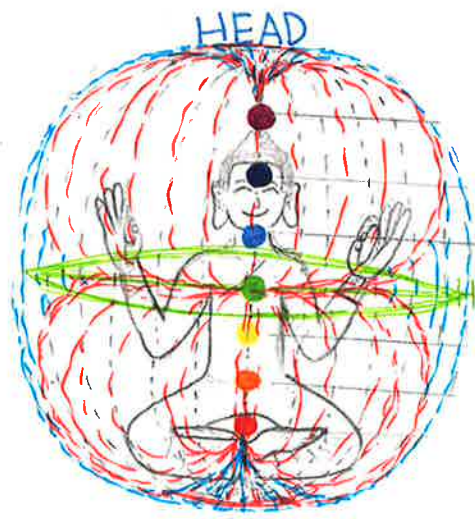
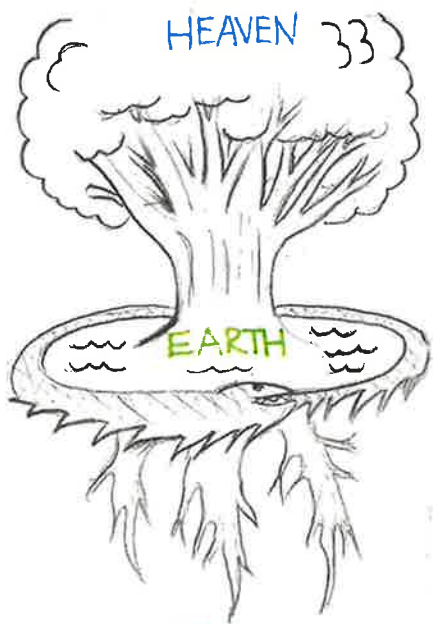
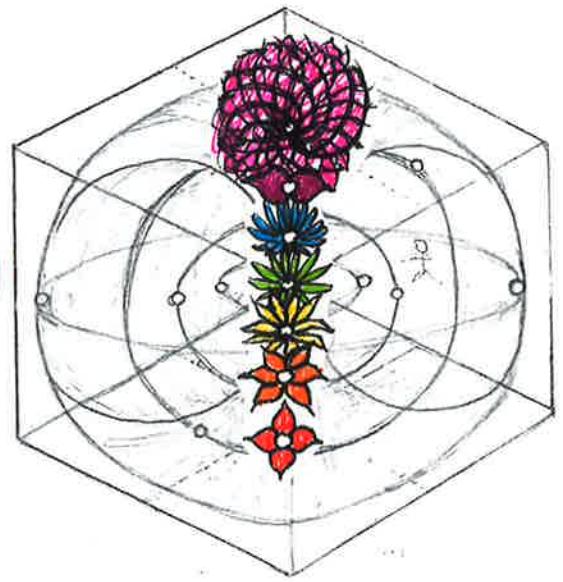
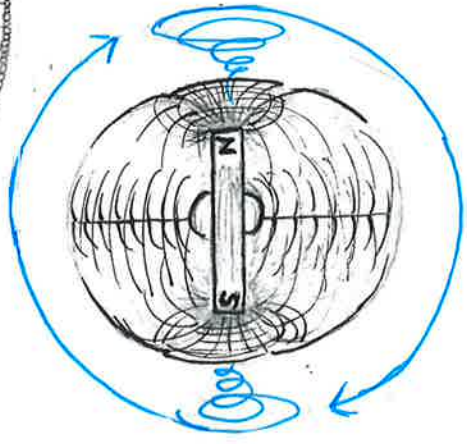
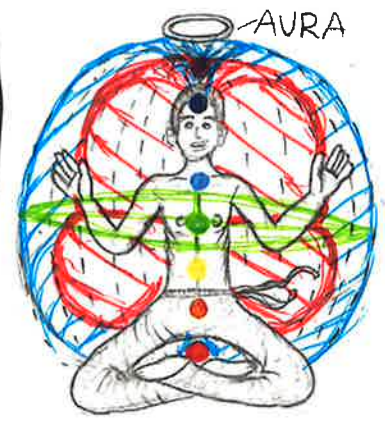
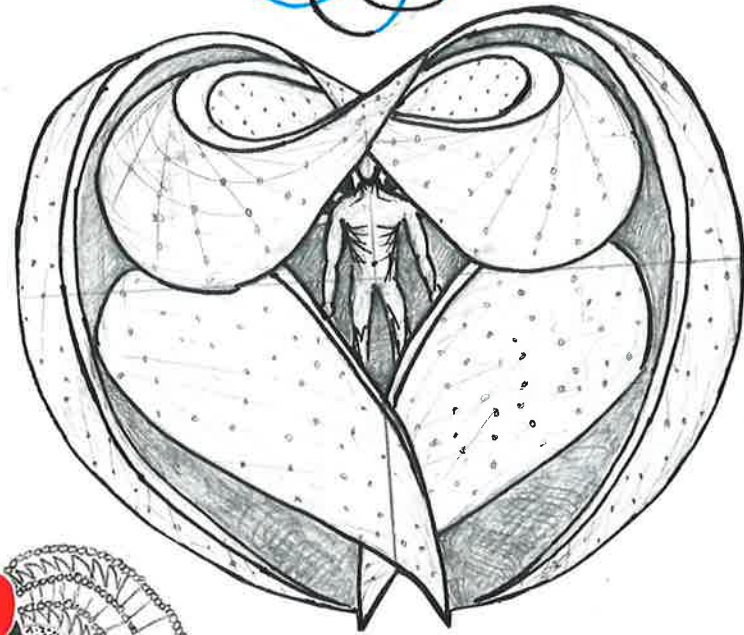
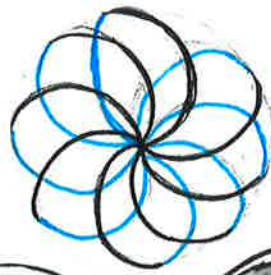

HELL

HEEL



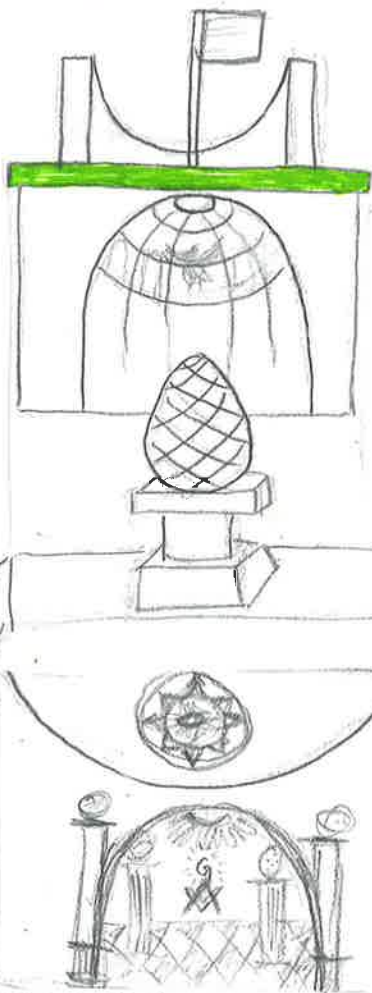

THE VATICAN MUSEI

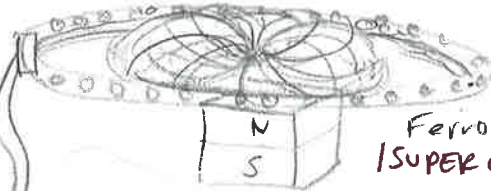

Ferro Cell / SUPER CELL

- INVENTED BY TIM VANDERPELLI  
- REINVENTED BY KEN WHEELER  
2 OPTICALLY FLAT PIECES OF GLASS + FERRO FLUID  
+ LED LIGHTS OR SUNLIGHT, + MAGNET.



DIABOLO

SATURN

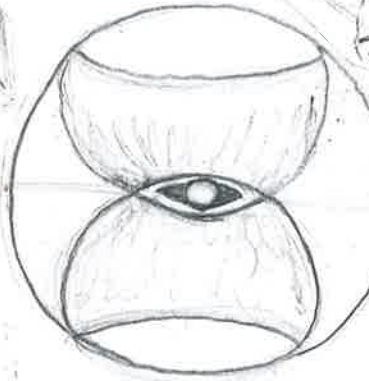

ALL LUMINARIES ARE "LIGHTS" IN THE SKY PRODUCED BY MAGNETISM. DISTURBANCES IN THE AETHER.

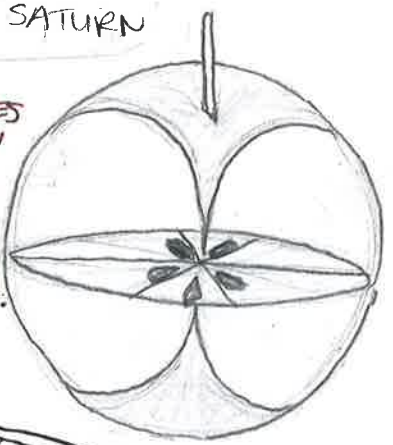

MASONIC APRON

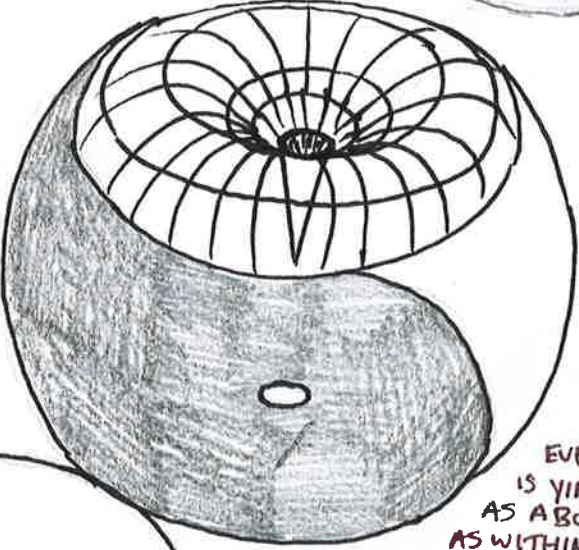
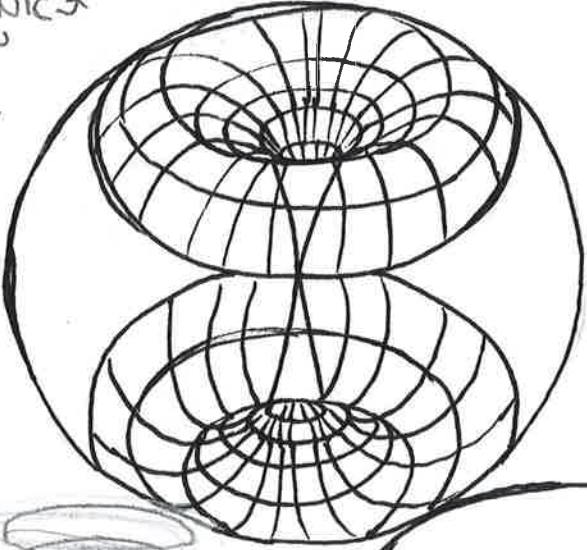

EVERY "THING" IS YIN & YANGS. AS ABOVE, SO BELOW AS WITHIN, SO WITHOUT.

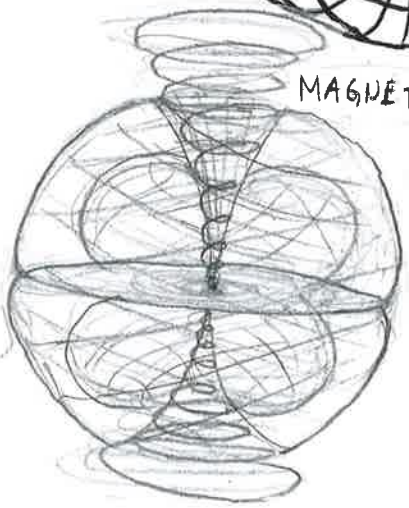

MAGNETISM

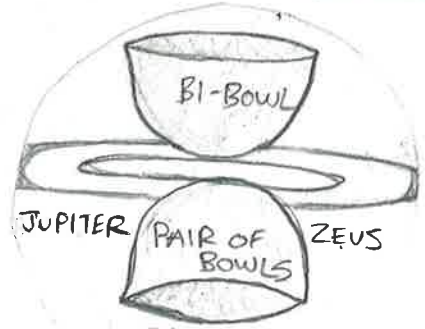
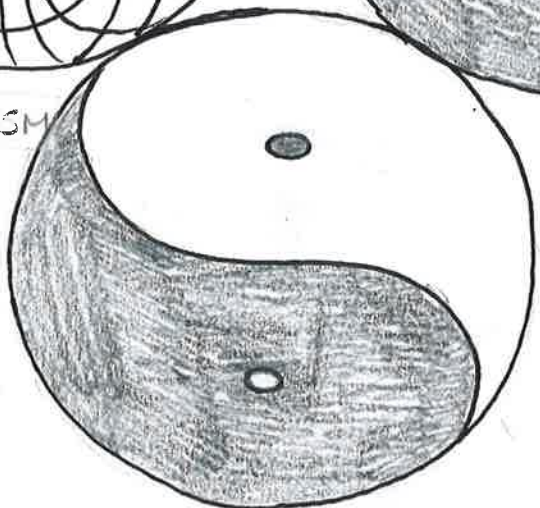

JUPITER

PAIR OF BOWLS

ZEUS



GEORGE CAREY: THE ZODIAC AND THE SALTS OF SALVATION. BOOK  
 Universal Truth School.com (Schussler Cell Salts)

ASTROCHEMICAL CHROMATIC CHART

♂	ARIES - I AM	Infant	Potassium Phosphate	Brazil Nuts	(Now)
♀	TAURUS - I HAVE	Baby	Sodium Sulphate	Kale	(Future)
♀	GEMINI - I THINK	child	Potassium Chloride	Apples	(Past)
♋	CANCER - I FEEL	Adolescent	Calcium Fluoride	Mushrooms	(Now)
♌	LEO - I WILL	Teenager	Magnesium Phosphate	Cherries	(Future)
♀	VIRGO - I ANALYZE	Adult	Potassium Sulphate	Onions	(Past)
♀	LIBRA - I BALANCE	Marriage	Sodium Phosphate	Tomatoes	(Now)
♏	SCORPIO - I DESIRE	Sex	Calcium Sulphate	Cucumbers	(Future)
♐	SAGITTARIUS - I SEE	Knowledge	Silica	Strawberries	(Past)
♑	CAPRICORN - I USE	Experience	Calcium Phosphate	Dandelions	(Now)
♒	AQUARIUS - I KNOW	Idealism	Sodium Chloride	Figs	(Future)
♓	PISCES - I BELIEVE	Submission	Ferrous Phosphate	Blue Berries	(Past)

BOOK  
 GEORGE W. CAREY -  
 GOD-MAN: THE  
 WORD MADE  
 FLESH. 1970

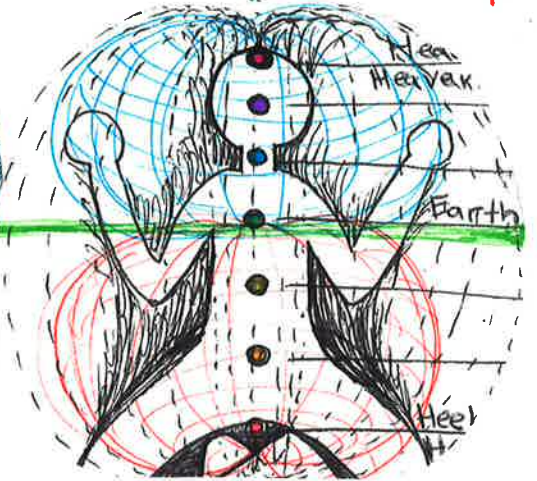
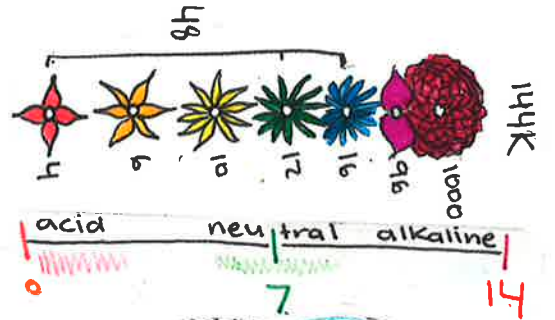
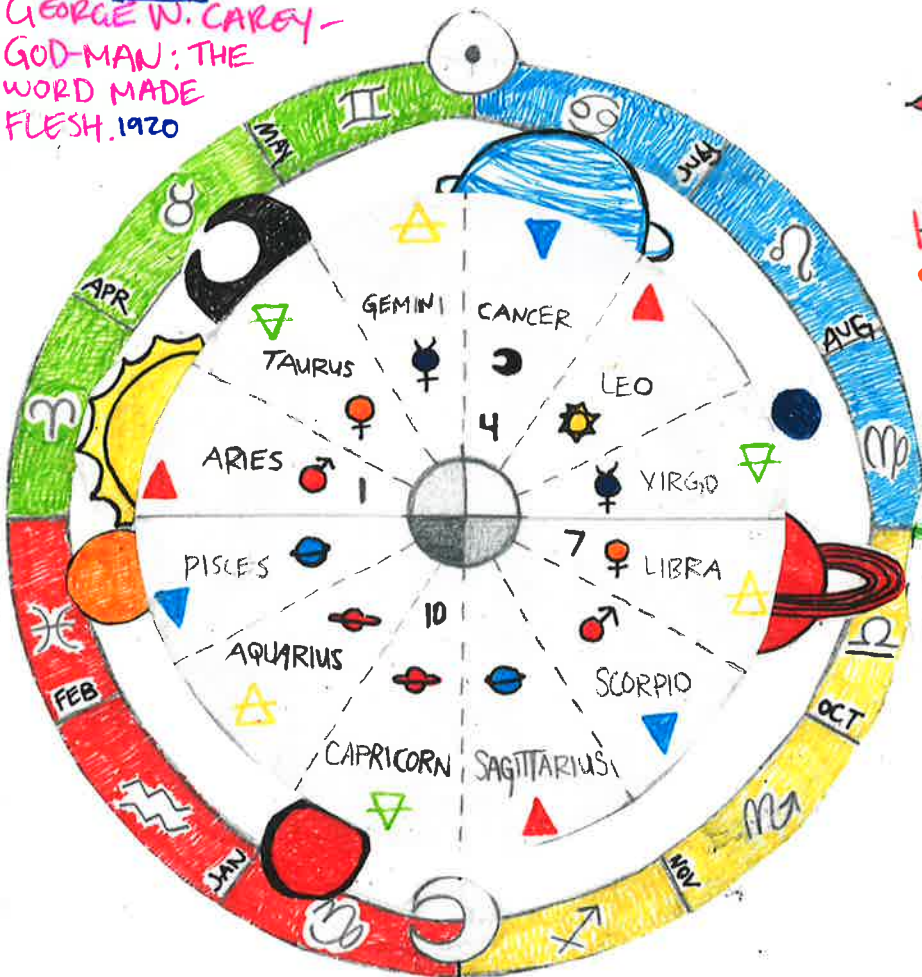

1 + 2 + 4 + 5 + 6 + 7 + 8 = 33  
 ♀ ♀ ♂ ♀ ♀ ♀ ♀ ♀  
  
 MEN · O · RAH

WE STAND ON THE SHOULDERS OF GIANTS.



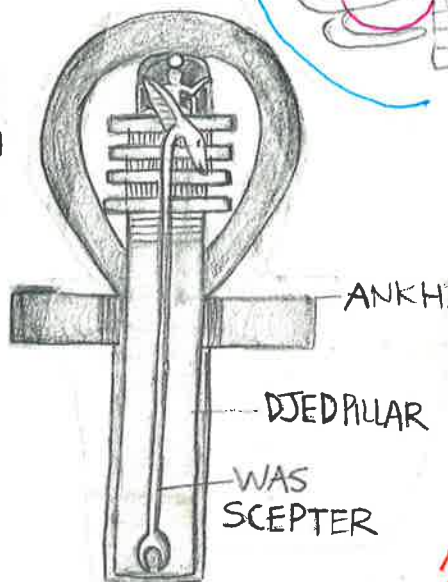
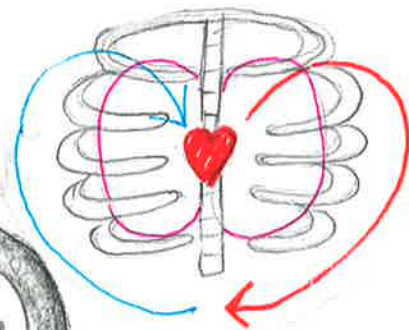
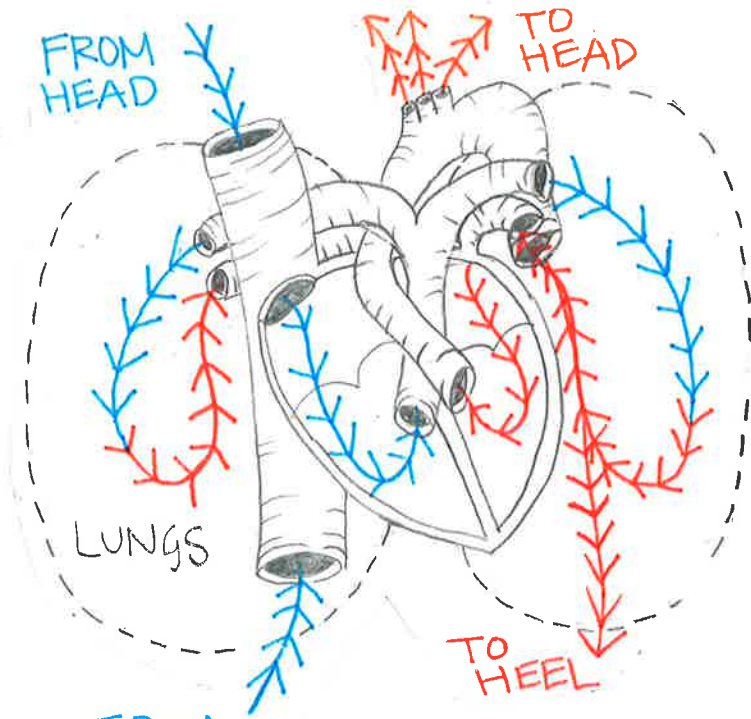

FROM HEEL

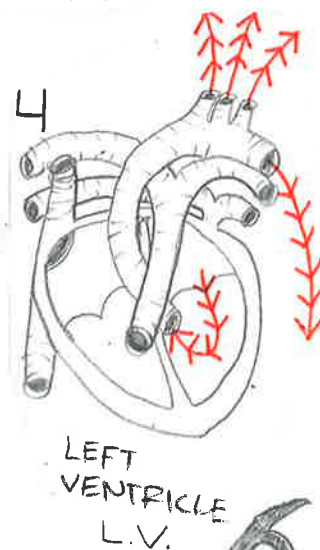
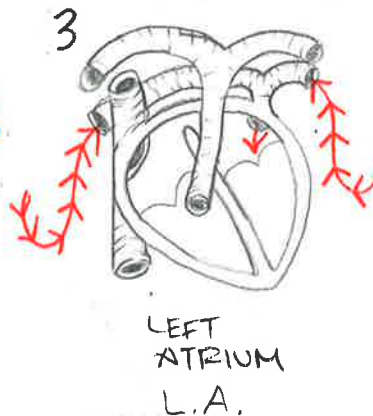
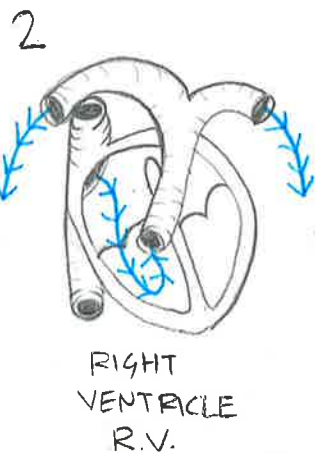

LIBRA

♀  
VENUS  
VEINS TO

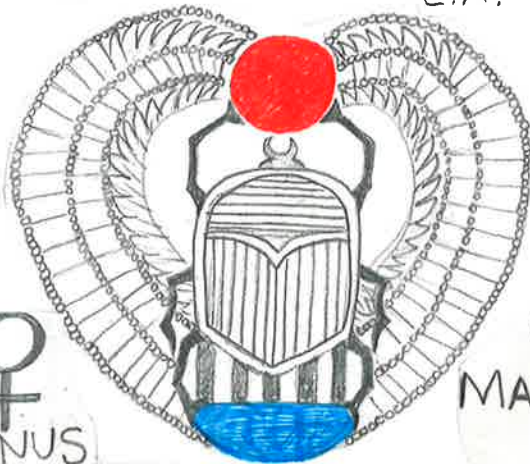

EGYPTIAN SCARAB

♂  
ARIES  
MARS

ARTERIES AWAY

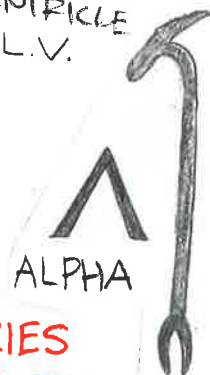

ARIES

"THAT WHICH IS VISIBLE COMES FROM THAT WHICH IS INVISIBLE."  
YOUR HEART DOES WHAT YOUR MAGNETIC FIELD, AND EVERY ATOM IS DOING. -DBBD

THE HEART PRODUCES THE ELECTROMAGNETIC BIO-FIELD.  
TORUS = RED  
HYPERBOLA = BLUE



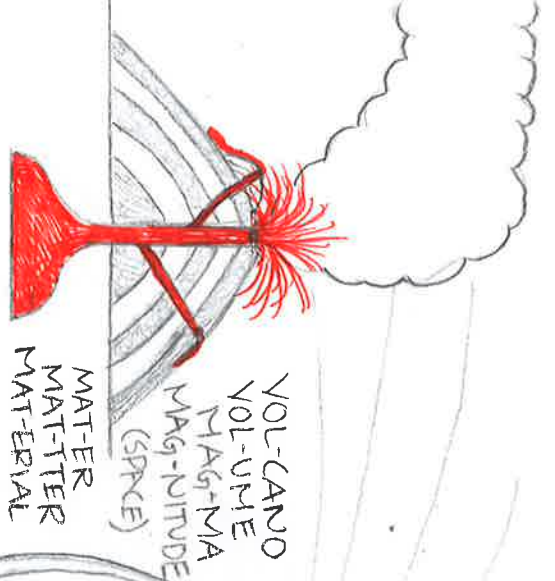

[ENGLISH] [SPANISH]  
TOWER = TORRE

(LMD)  
Largitudinal  
Magneto Dielectricity

TELE-  
FOREI

TOSUAI  
POWER  
TOWER

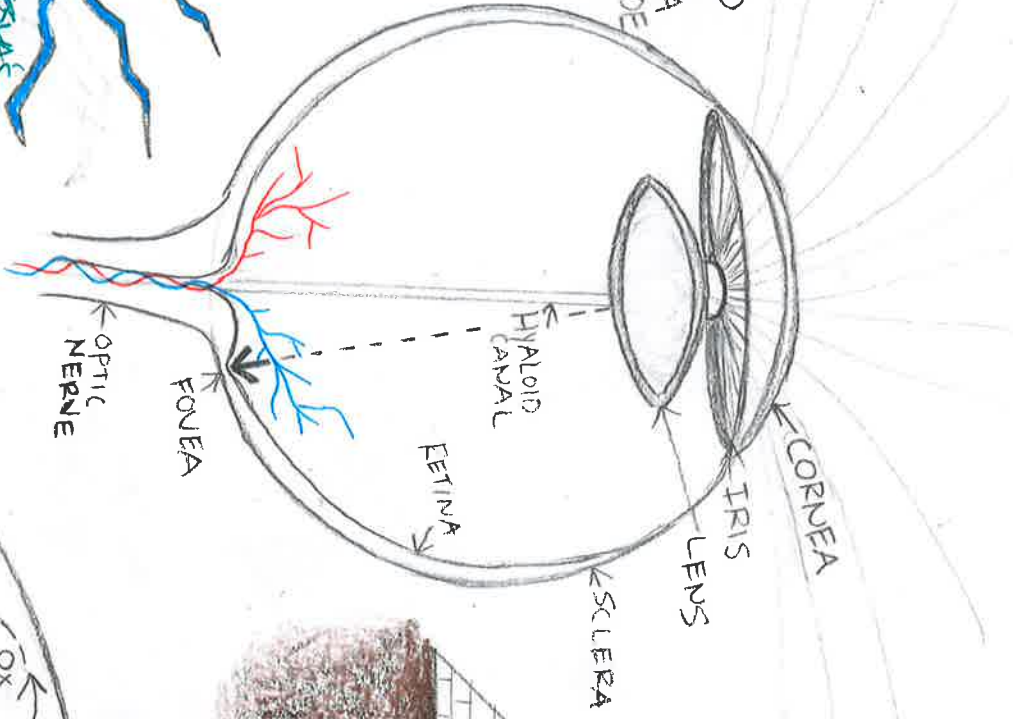
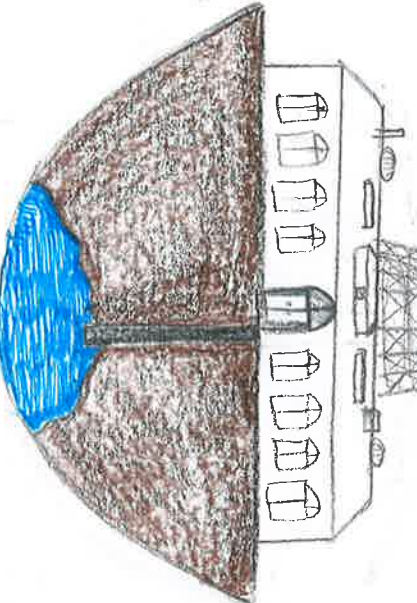

VOR-TEX  
TOR-VAADO

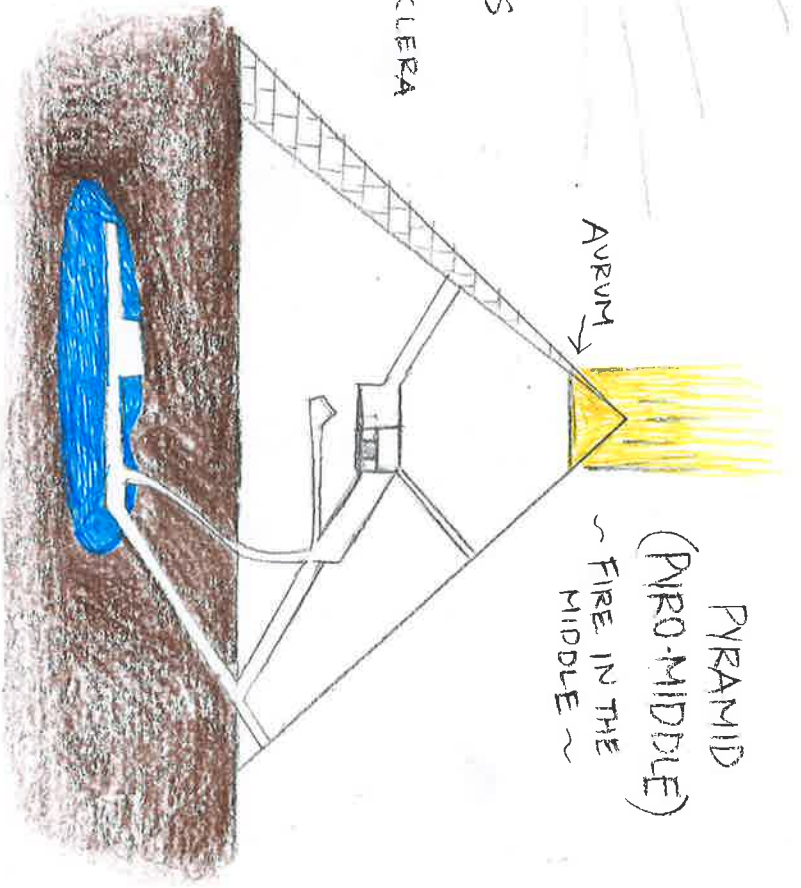

COR-E

~ THE GIVING TREE OF LIFE ~

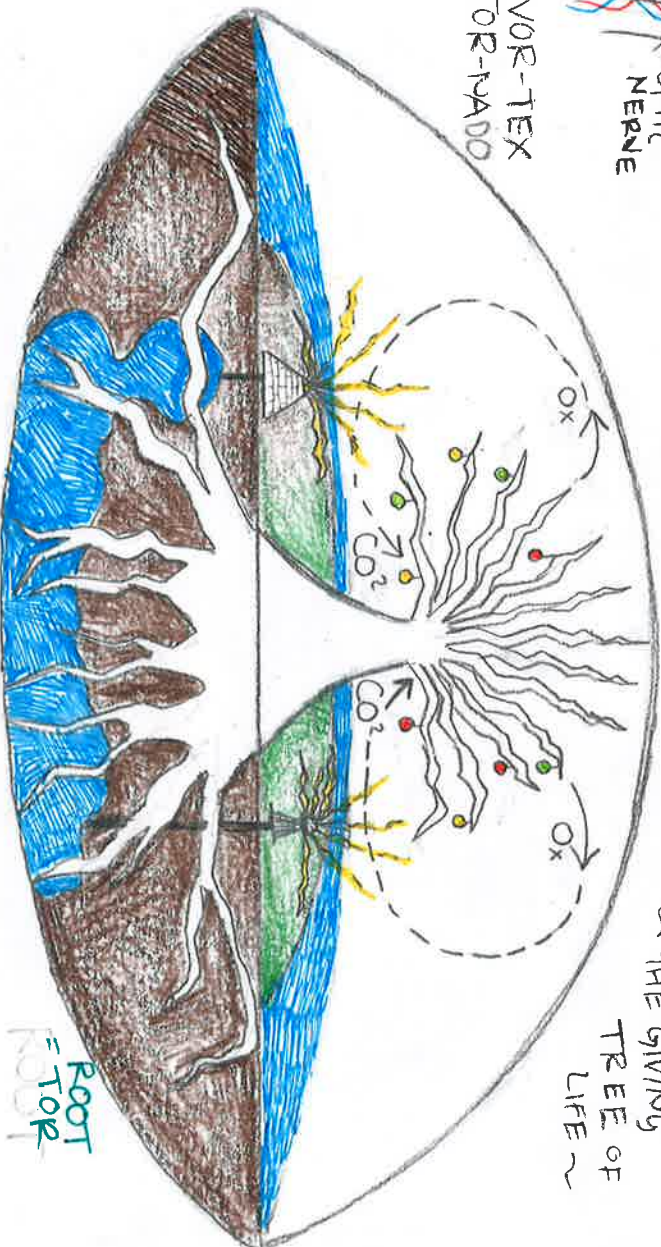



**PURIFICATION = PYRO-FICATION!**

**LUKE 3:16** "INDEED I BAPTIZE YOU BY WATER, BUT ONE MIGHTIER THAN I IS COMING, HE WILL BAPTIZE YOU WITH THE HOLY SPIRIT AND FIRE."

**MARK 14:62** "I AM, AND YOU SHALL SEE THE SON OF MAN SITTING AT THE RIGHT HAND OF POWER, AND COMING WITH CLOUDS IN HEAVEN."

**ACTS 2:33** THEREFORE HAVING BEEN EXALTED TO THE RIGHT HAND OF GOD AND HAVING RECEIVED FROM THE FATHER THE PROMISE OF THE HOLY SPIRIT, HE HAS Poured FORTH THIS WHICH YOU BOTH SEE AND HEAR."

**HEBREWS 11:3** "THE UNIVERSE WAS FORMED BY THE WORD OF GOD, SO THAT WHAT IS SEEN WAS NOT MADE OUT OF WHAT IS VISIBLE."

**EPHESIANS 6:12** "FOR OUR STRUGGLE IS NOT AGAINST FLESH AND BLOOD, BUT AGAINST THE AUTHORITIES, AGAINST THE POWERS OF THIS DARK WORLD, AND AGAINST THE SPIRITUAL FORCES OF EVIL IN THE HEAVENLY REALMS."

**David Lynch** "It has always been there, never had a beginning, it is, it was and it will be forever, Any human being can Experience this."

**ACTS 26:18** "OPEN THE EYES OF OTHERS AND TURN THEM FROM DARKNESS TO LIGHT, AND FROM THE POWER OF SATAN TO GOD."

**GENESIS 28:11** "WHEN HE REACHED A CERTAIN PLACE HE STOPPED FOR THE NIGHT BECAUSE THE SUN HAD TO SET. TAKING ONE OF THE STONES THERE HE PUT IT UNDER HIS HEAD AND LAY DOWN TO SLEEP. HE HAD A DREAM IN WHICH HE SAW A STAIRWAY RESTING ON EARTH, WITH ITS TOP REACHING HEAVEN AND THE ANGELS OF GOD WERE ASCENDING AND DESCENDING ON IT. THERE ABOVE IT STOOD THE LORD. I AM THE LORD, THE GOD OF YOUR FATHER ABRAHAM AND GOD OF ISAC. I WILL GIVE YOU AND YOUR DESCENDANTS THE LAND ON WHICH YOU ARE LYING. EARLY THE NEXT MORNING, JACOB TOOK THE STONE HE HAD PLACED UNDER HIS HEAD AND SET IT UP AS A PILAR, HE Poured OIL ON TOP OF IT, AND CALLED THE PLACE BETHEL. SO JACOB LEFT ALONE AND A MAN WRESTLED WITH HIM UNTIL DAY BREAK, WHEN THE MAN SAW THAT HE COULD NOT OVERPOWER HIM HE TOUCHED HIS SOCKET OF HIS HIP, SO THAT HIS HIP WAS WRENCHED"

REVELATION 21:13 ON THE EAST 3 GATES, THE NORTH 3 GATES, SOUTH 3 GATES AND ON THE WEST 3 GATES.  
**THE 12 ZODIACS**

**I.N.R.I** - TO COMPLETE THE CYCLE, NATURE IS REBORN THROUGH FIRE, TIME IS PERPETUAL AND CYCLICAL (OUR BOKOS)  
**IGNE - FIRE**  
**NATURA - NATURE**  
**RENOVATUR - RENEWED**  
**INTEGRA - COMPLETE**  
WE CELEBRATE THE NEW YEAR IN SPRING (ARIES RULED BY MARS - FIRE)

**REV 4** AFTER THIS I LOOKED AND THERE BEFORE ME WAS A DOOR STANDING OPEN IN HEAVEN, AND THE VOICE I HAD HEARD SPEAKING TO ME LIKE A TRUMPET SAID "COME UP HERE" AND I WILL SHOW YOU WHAT MUST TAKE PLACE AFTER THIS. AT ONCE I WAS IN THE SPIRIT AND THERE BEFORE ME WAS A THRONE IN HEAVEN WITH SOMEONE SITTING ON IT. AND THE ONE WHO SAT THERE HAD THE APPEARANCE OF JASPER AND A RUBY, A RAINBOW THAT SHOWN LIKE AN EMERALD ENCIRCLED THE THRONE, SURROUNDING THE THRONE WERE 24 ELDERS DRESSED IN WHITE, AND CROWNS OF GOLD ON THEIR HEADS, FROM THE THRONE CAME FLASHES OF LIGHTNING, RUMBLES AND PEALS OF THUNDER, IN FRONT OF THE THRONE 7 LAMPS WERE BLAZING, THESE ARE THE 7 SPIRITS OF GOD, IN FRONT OF THE THRONE WAS A SEA OF GLASS CLEAR AS CRYSTAL, SURROUNDED BY 4 LIVING CREATURES, COVERED WITH EYES FRONT & BACK, WITH FACES OF A LION, OX, MAN AND A FLYING EAGLE. EACH HAD 6 WINGS AND EYES UNDER ITS WINGS, DAY AND NIGHT THEY NEVER STOP SAYING "HOLY HOLY HOLY, IS THE LORD ALMIGHTY, WHO WAS, AND IS, AND IS TO COME." - THE PINEAL SURROUNDED BY THE 24 CRANIAL NERVES.

**SANTA SAYS HO, HO, HO GIFT FOR US ALL**

(CONT) THEN THE MAN CHANGED JACOBS NAME TO ISRAEL SO JACOB CALLED THE PLACE BETHEL AND MY LIFE HAS BEEN PRESERVED.



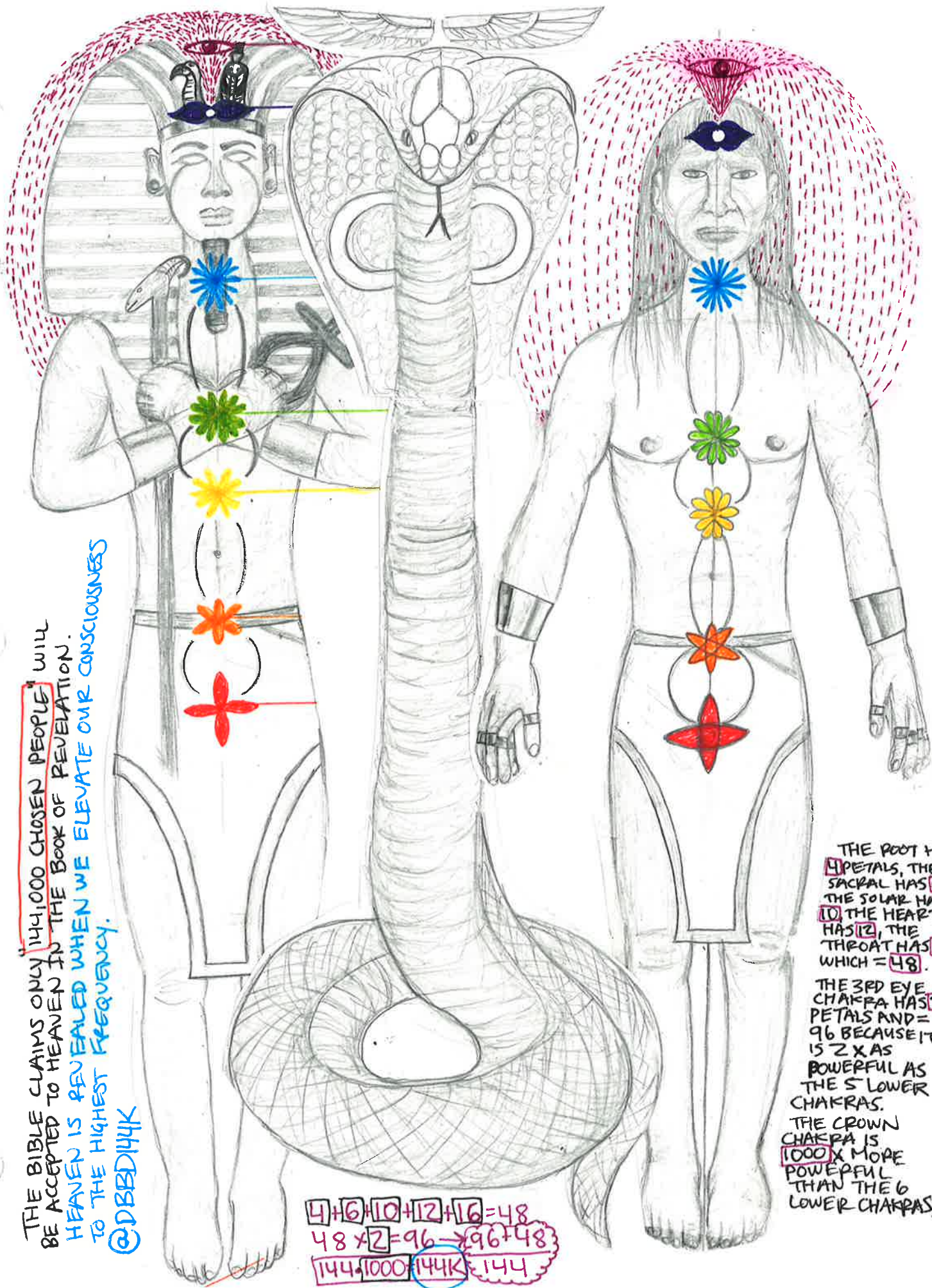

THE BIBLE CLAIMS ONLY 144,000 CHOSEN PEOPLE WILL BE ACCEPTED TO HEAVEN IN THE BOOK OF REVELATION. HEAVEN IS REVEALED WHEN WE ELEVATE OUR CONSCIOUSNESS TO THE HIGHEST FREQUENCY.  
 @DBBD144K

$4 + 6 + 10 + 12 + 16 = 48$   
 $48 \times 2 = 96 \rightarrow 96 + 48$   
 $144, 1000, 144K, 144$

THE ROOT HAS 4 PETALS, THE SACRAL HAS 6, THE SOLAR HAS 10, THE HEART HAS 12, THE THROAT HAS 16 WHICH = 48.  
 THE 3RD EYE CHAKRA HAS 2 PETALS AND = 96 BECAUSE IT IS 2 X AS POWERFUL AS THE 5 LOWER CHAKRAS.  
 THE CROWN CHAKRA IS 1000 X MORE POWERFUL THAN THE 6 LOWER CHAKRAS.



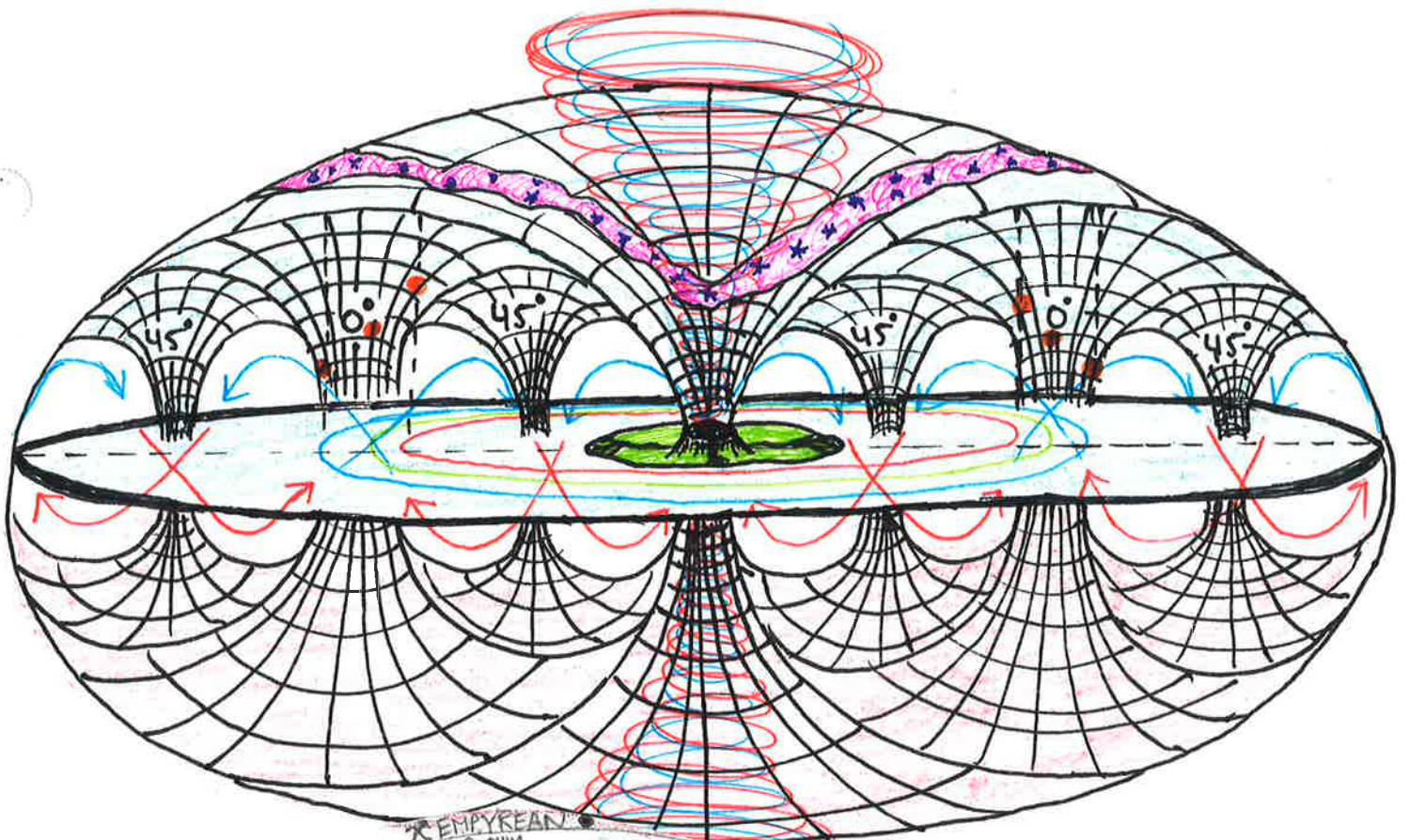

- X EMPYREAN
- 5 SERAPHIM
- 3 CHERUBIM
- 4 DOMINIONS
- 11 THRONES
- 7 POWERS
- 7 PRINCIPALITIES
- 11 VIRTUES
- 12 ARCHANGELS
- 7 ANGELS

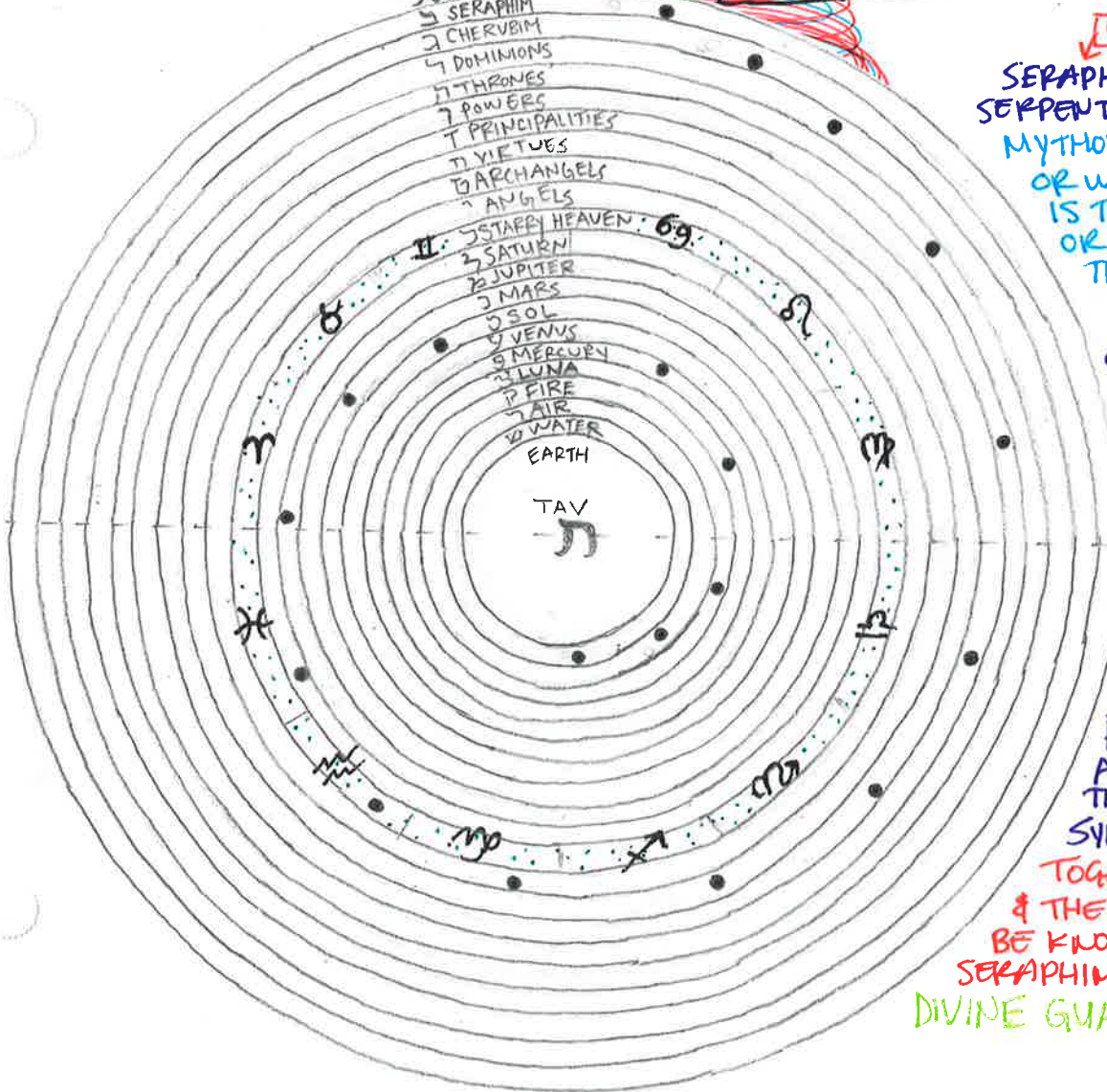

**QUALITY**

SERAPHIM = FLORY FLYING SERPENTS OF OLD... IN MYTHOLOGY, THE DRAGON OR WINGED SERPENT, IS THE PROTECTOR OR DEFENDER OF THE CASTLE & THE ROYAL FAMILY.

**POSITION**

CHERUBIM = HOLY ANGELS THAT GUARD THE GARDEN OF EDEN, THE PROMISED LAND FLOWING WITH MILK & HONEY.

THE EGYPTIAN CROWNS WORN BY GODS AND GODDESSES PORTRAYED SERPENTS AND VULTURES AROUND THE HEAD, WHICH ARE SYMBOLS OF PROTECTION, TOGETHER THE SERPENT & THE VULTURE COME TO BE KNOWN AS THE SERAPHIM, IN THE BIBLE. DIVINE GUARDIANS ~



# THE ALCHEMICAL MARRIAGE

- SANTOS BONACCI

YOUTUBE - "RAISING THE CHRISM OIL PART. 1" @MR ASTRO THEOLOGY



CHIRAM ABIFF = HIGH RAM ABOVE

THE PINEAL GLAND "JOSEPH" SECRETES THE HONEY AND THE PITUITARY GLAND "MARY" SECRETES THE MILK. THEY BOTH COME FROM THE SAME SOURCE, THE "HOLY CLAUSTRUM" WHICH MEANS CLOISTER OR CLOSET, AND FOR A VERY GOOD REASON THAT A PRECIOUS OR HOLY THING IS SECRETED THERE. IT IS INDEED A GIFT FOR EACH AND EVERY ONE OF US. THE 2 NERVES THAT COME FROM THE PINEAL AND PITUITARY GLANDS DESCEND ALL THE WAY DOWN THE SPINE, THEY ARE THE 2 SNAKES, THE IDA AND THE PINGALA, WHICH HOLD THE 2 OILS, THAT TRAVEL DOWN INTO THE SOLAR PLEXUS VIA THE SEMILUNAR GANGLION PNEUMOGASTRIC NERVE OR THE VAGUS NERVE OF THE 12 CRANIAL NERVES. IN THE SOLAR PLEXUS, IS WHERE THE PSYCHO-PHYSICAL GERM, THE FRUIT OF THE TREE OF LIFE IS BORN, IN THE MANGER, IN THE HOUSE OF BREAD, BETHLEHEM, IN VIRGO THE BELLY. THE IDA (RED) AND PINGALA (BLUE), THE 2 NERVE FLUIDS WHERE AT THE MEDULLA OBLANGATA, THEY CROSS EACH OTHER, WHICH IS WHERE THE CRUCIFIXION TAKES PLACE, AND IT RESTS FOR 2 AND A HALF DAYS. THE SACRED OIL RETURNS AFTER CROSSING THE MEDULLA IT ENTERS THE CEREBELLUM, "GOLGOTHA" THE PLACE OF THE SKULL, THE CEREBROSPINAL FLUID, 'CHRISM OIL', IS REFINED A THOUSAND FOLD. X 1,000. @ THE CEREBRUM. "THE CHRISTI" →

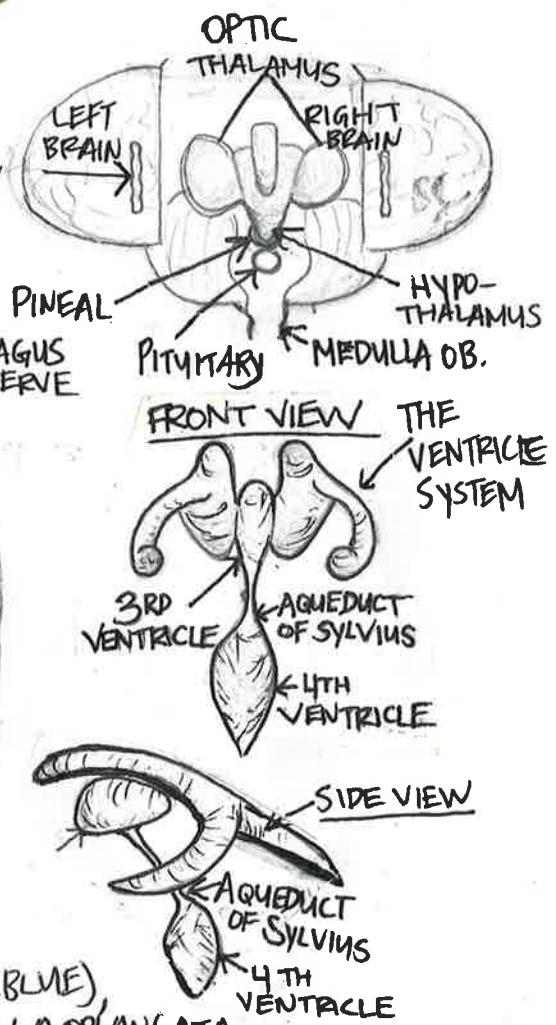
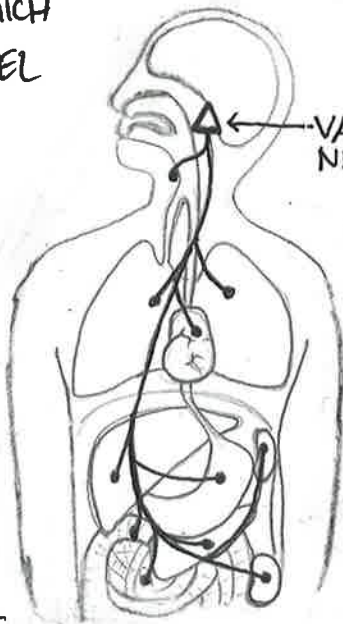



AQUARIUS

THE FOUNTAIN IN THE SKULL

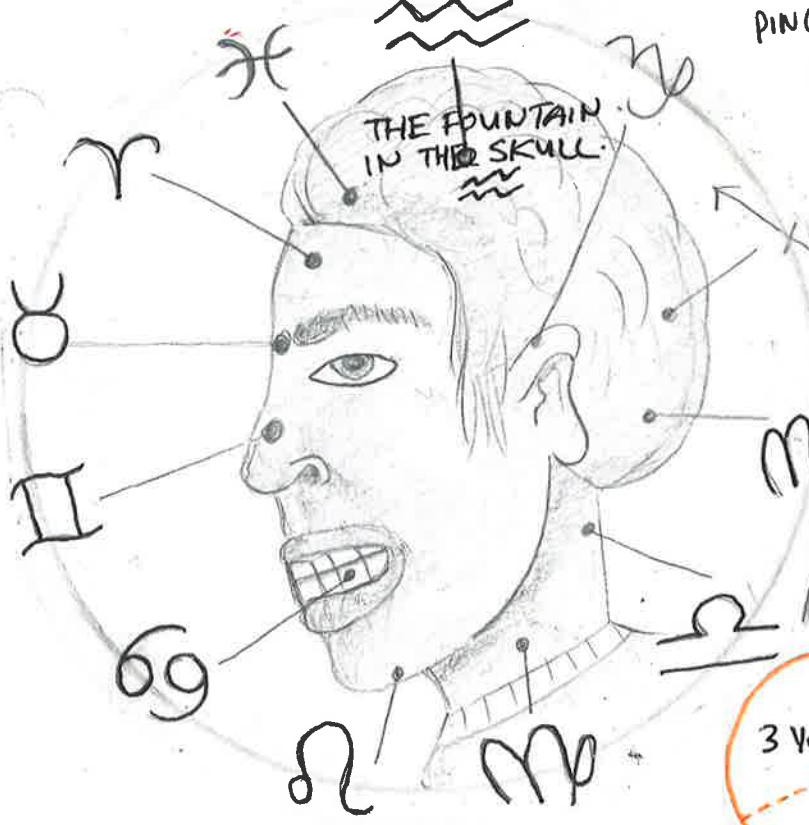

PINGALA  
Pineal

IDA  
Pituitary



CERE-BRUM  
FONTANEL  
Fountain of Youth

— YOUR SKULL IS THE FOUNTAIN OF YOUTH.

CERE-BRUM

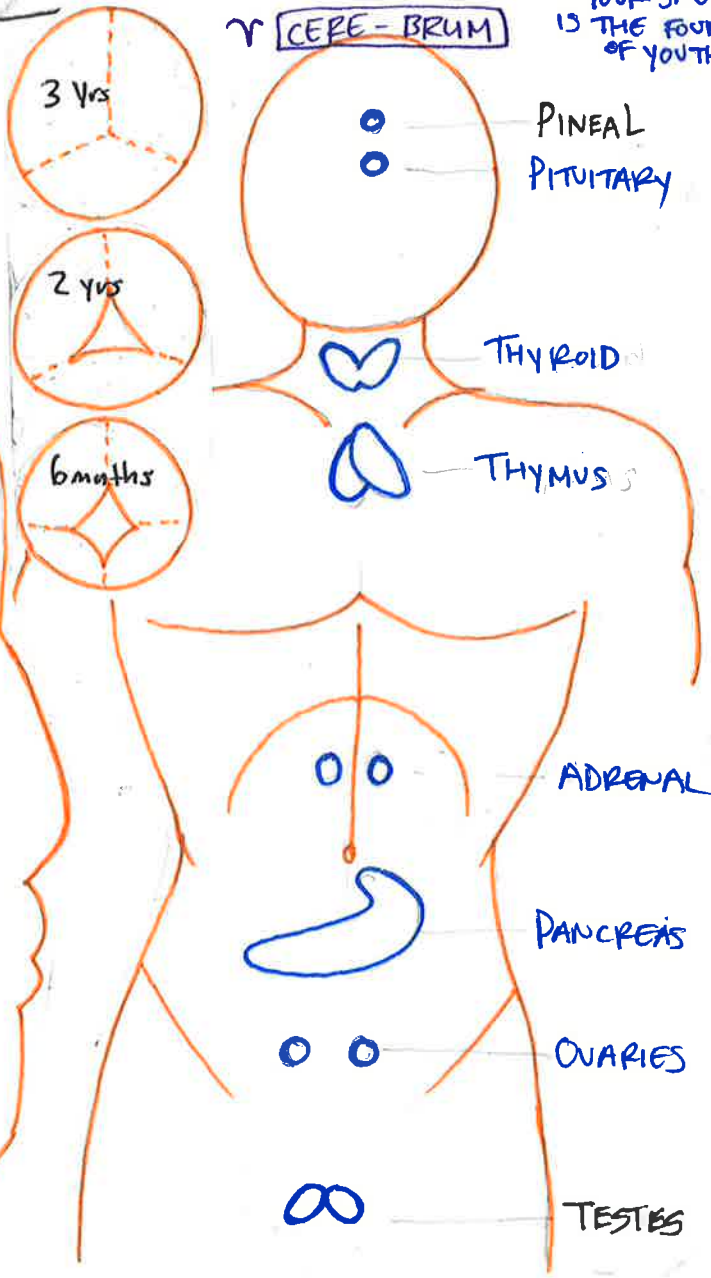

CERE-BRUM

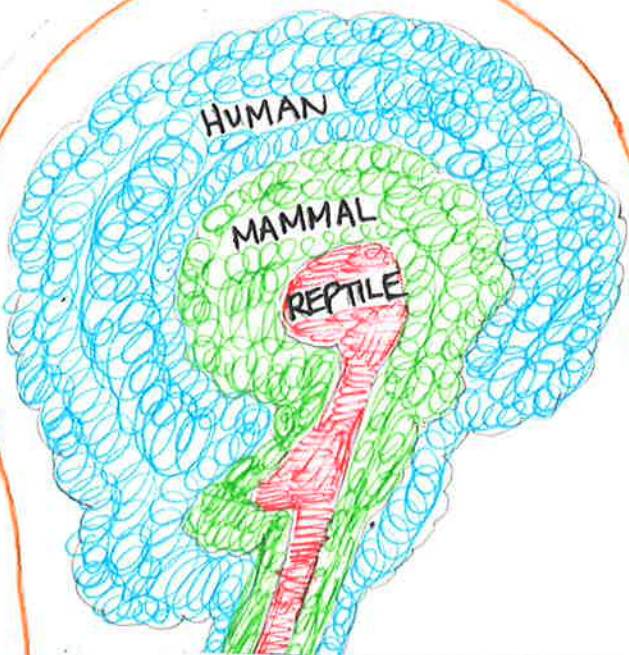

Human (Neo Cortex)	Thinking
Mammilian (Limbic)	Emotional
Reptilian (Reptile)	Instinctual



# SYNCRETISM

## THE BIBLE JESUS VS SAT

ADAM + EVE = CAIN & ABE [VS]  
 ABRAM + SARAI = ISAC & ISHMAEL  
 ISAC + REBEKAH = JACOB & ESAU [VS]  
 JACOB + RACHEL + LEAH + ZILHA + BILPAH = 12 CHILDREN [12]  
 GOD + MARY = JESUS CHRIST

MOSES VS SET  
 PHARAOH SETI + JOCHEBED  
 = MOSES & RAMSES [VS]

## GREECE ZEUS VS SAT

OURANOS + GAIA = KRONOS & RHEA ♥  
 KRONOS + RHEA = ZEUS & HERA ♥  
 ZEUS + LETO + MAIA + DIONE + HERA = APOLLO ♥ ARTEMIS, HERMES ♥ AFRODITE, ARES [12]

## EGYPT HORUS VS SET

ATUM + NUN = ALL  
 SHU + TEFNUT = GEB & NUT ♥  
 GEB + NUT = OSIRIS ♥ ISIS, NEPTHY, SET [VS]  
 OSIRIS + ISIS = HORUS

## MESOPOTAMIA ENKI VS ENLIL

ANSHAR + KISHAR = ANU + KI ♥  
 ANU + KI = ANUNNAKI, ENLIL & ENKI [VS]  
 APSUCABZU) = SWEET WATER + NAMMU (TIAMAT) = SALT WATER

## NORSE THOR VS SURTUR

ODIN + FRIGGA = THOR & HELA  
 FREYER + FREYA

## STARWARS LUKE VS SITH

SITH LORD + SHMI = ANAKIN SKYWALKER  
 ANAKIN + PADME = LUKE & LEIA ♥  
 LUKE + — = REY SKYWALKER  
 HAN + LEIA = KYLO REN  
 KYLO + REY = ONENESS



7  
 THE ELOHIM ARE THE ELECTRONS THAT ORBIT THE NEUTRON.



12 HOUSES, 36 DECANS - 48 CONSTELLATIONS

THE WORD JUPITER IS IN-PATER = ZEUS THE FATHER

HELL WINTER = INVERNO INFERNO

ITALIAN

THOR = GOD OF GODS  
JESUS = KING OF KINGS  
ZEUS = MT OLYMPUS  
JESUS = MT OLYMPUS  
THE DISCIPLES

II \* THE DOVE - COLUMBA IS AN ASTERISM IN GEMINI

\* CANOPUS IS THE 2ND BRIGHTEST STAR IN THE SKY.

CASSIOPEIA = MARY

WHERE THE EXALTS EVERY MORNING (AM) PERSEUS SLAYS MEDUSA THE STAR-LIT NIGHT.

TWINS OF GEMINI - CASTOR AND POLLUX

ARGO NAVIS IS THE ARK, JASON AND HIS ARGO-NAUTS.

\* THE NORTH & SOUTH DONKEYS, ASELLUS BOREALIS & ASELLUS AUSTRALIS.

ORION THE HUNTER, SLAYS THE BULL.

THE ERIDANUS RIVER, IS THE JORDAN RIVER WHERE JESUS IS BAPTIZED BY JOHN.

Ancient Greek CEPHAS = ROCK

JESUS CHANGES SIMONS NAME TO PETER = THE ROCK

JESUS AT THE SEA OF GALILEE, SEES THE 2 BROTHERS CALLED PETER & HIS BROTHER ANDREW.

THE KING CEPHEUS AND HIS WIFE QUEEN CASSIOPEIA'S DAUGHTER ANDROMEDA, IS CHAINED TO A ROCK, TO BE DEVOURD BY A SEA MONSTER SENT BY POSEIDON.



HYDRA THE SNAKE, ALSO CALLED THE ARCH OF THE WATERY HEAVEN. CRATER THE HOLY GRAIL. \* REGULUS THE BRIGHTEST STAR IN LEO

BOOTES IS ADAM THE GOOD SHEPHERD, VIRGO IS EVE.

\* VIRGO MARY CRIES AS SHE SEES HER SON DIE @ THE CROSSING OF THE EQUINOX.

THE SUN FALLS IN LIBRA, DIES ON THE CROSS AND WEARS A CROWN, JUST AS ASTROLOGY DESCRIBES. JUDAS = CRIPPLED

SCORPIO BETRAYS THE SUN AND BITES HIM IN THE BACK. \* JUDAS BETRAYS THE SON OF GOD FOR 30 PIECES OF SILVER, JUST AS BRUTUS BETRAYS JULIUS CAESAR FOR 20 PIECES OF GOLD.

JESUS IS TEMPTED BY THE DEVIL IN THE GARDEN OF GETHSEMANE. \* THE SUN IS ALWAYS TEMPTED BEFORE WINTER, TO GO AND DIE, AND NEVER COME BACK.

AND WHEN THE SUN IS IN ARIES @ NIGHT WE CAN LOOK UP AND SEE VIRGO AND BOOTES.

BUT WHEN THE SUN ENTERS LIBRA, WE CAN LOOK UP AND SEE PERSEUS WITH HIS FLAMING SWORD, NOW GUARDING THE HEAVENS @ MIDNIGHT.

GENESIS 3:24

"HE DROVE OUT THE MAN AND HE PLACED @ THE EAST OF THE GARDEN OF EDEN, CHERUBIM AND A FLAMING SWORD WHICH TURNED EVERY WAY.

\* PERSEUS TAKES OVER WHEN ADAM & EVE ARE KICKED OUT OF THE SKY. FROM SUMMER MONTHS, TO WINTER MONTHS. SO GOD GAVE THEM GARMENTS.

\* JESUS IS THE LAMB OF GOD (PARIES) WHO TAKES AWAY THE SINS OF THE WORLD. (TAKES AWAY THE WINTER)

LORD SAID TO MOSES EXODUS 12:1 "THIS MONTH IS TO BE FOR YOU, THE FIRST MONTH OF YOUR YEAR."

EXODUS 12:13 "WHEN I SEE THE BLOOD I WILL PASSOVER YOU."

EXODUS 12:7 "THEN THEY ARE TO TAKE SOME OF THE BLOOD AND PUT IT ON THE SIDES AND TOPS OF THE DOOR FRAMES OF THE HOUSES WHERE THEY EAT THE LAMBS. THAT SAME NIGHT, EAT THE LAMB MEAT ROASTED OVER THE FIRE."

MEN COME FROM THE MILKY WAY THROUGH THE MOON, @ THE TROPIC OF CANCER, AND WE FALL TO LEO AND DRINK FROM THE CUP OF INTOXICATION, THEN WE GET SEDUCED, THEN @ LIBRA WE GET JUDGED, AND BETRAYED BY OUR FRIENDS THEN WE PLAY THE HARP AND MAKE A SACRIFICE BEFORE CONQUERING THE TITANS, LIKE SATURN, KRONOS (FATHER TIME) THE ONE WHO EATS HIS OWN CHILDREN | THOSE WHO ARE BORN IN TIME, DIE IN TIME.

SAGITTA IS THE ARROW OF THE ARROW OF POINTING TO THE FOOT OF OPHIUCUS AND KILLING HIM.

\* THE FLOCKS IS AN ASTERISM IN CAPRICORN. THERE WERE FLOCKS OUT WHEN JESUS WAS BORN. \* SLAUGHTER THEM @ TWILIGHT. \* X3 = 360°

\* DRACO IS THE SERPENT, DRAGON, THE DEVIL, THE CONSTELLATION IS 120° IN LENGTH, IT IS THE DRAGON IN REVELATION, THAT WIPES DOWN 1/3 OF THE HEAVENS. 120° OF THE STARS.

YT: MR. ASTROTHEOLOGY! SYNCRETISM!

DEC. 25 = "DEUS NATALIS SOLIS INVICTI" THE BIRTHDAY OF THE INVINCIBLE SUN.

JESUS IS THE LAMB OF GOD (ARIES) AND HE FEEDS 1000 WITH 2 FISH (PISCES) - HE IS THE BEGINNING & THE END.



**GREEK**

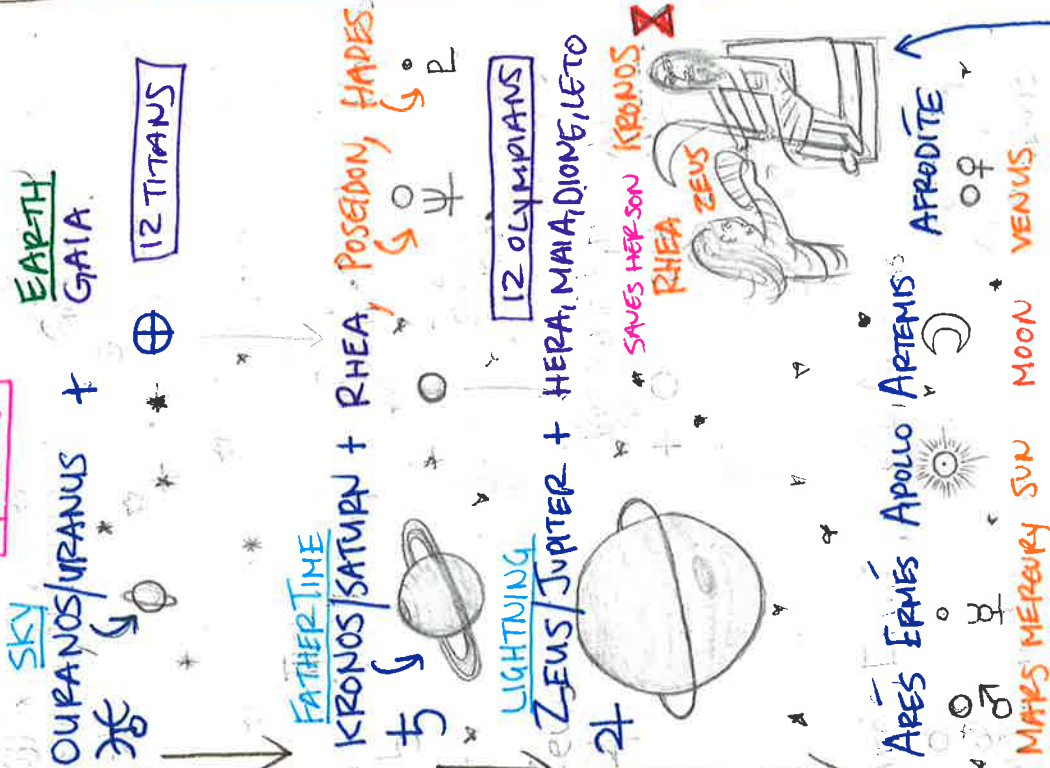

**BIBLE**



**EGYPT**

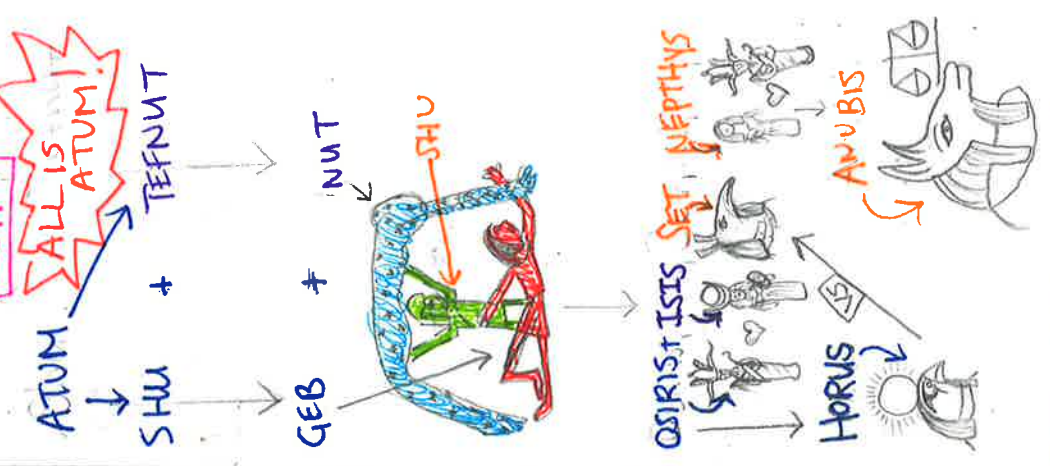

**NORSE**



**BIBLE**

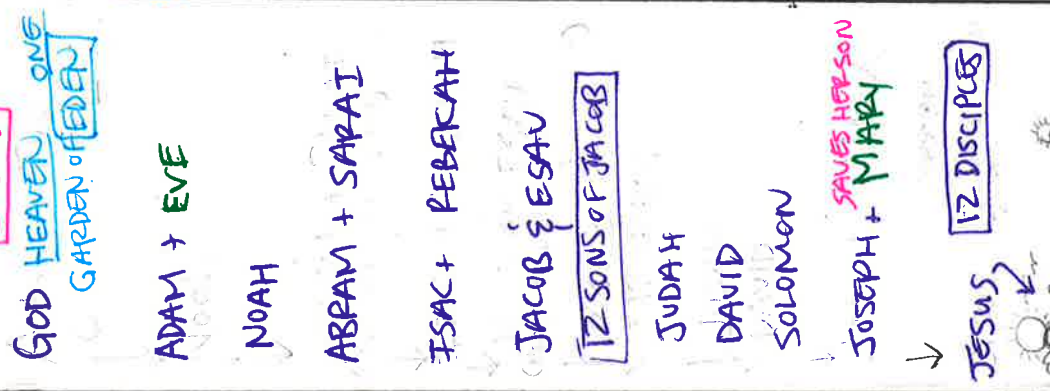

JESUS SITS AT THE RIGHT HAND OF GOD, RIGHT HEMISPHERE OF THE BRAIN.

**MESOTAMIA**





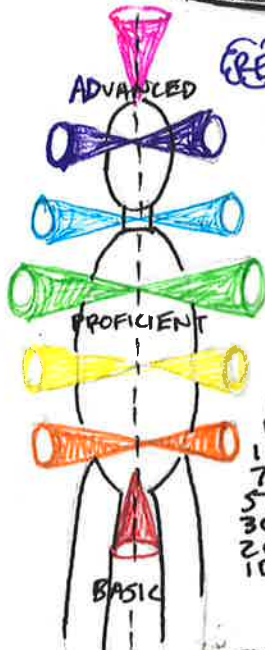
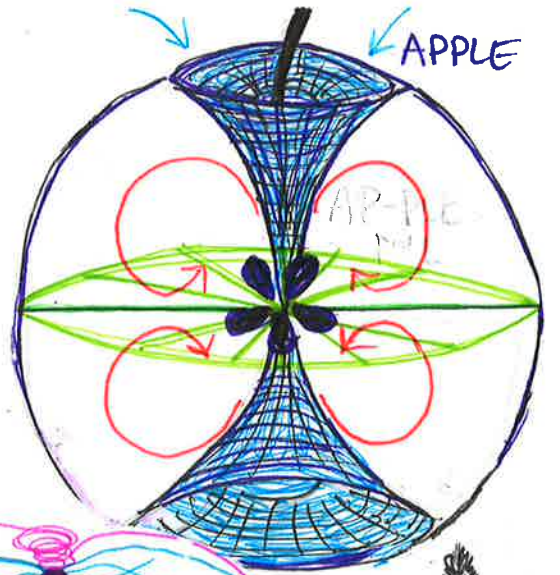
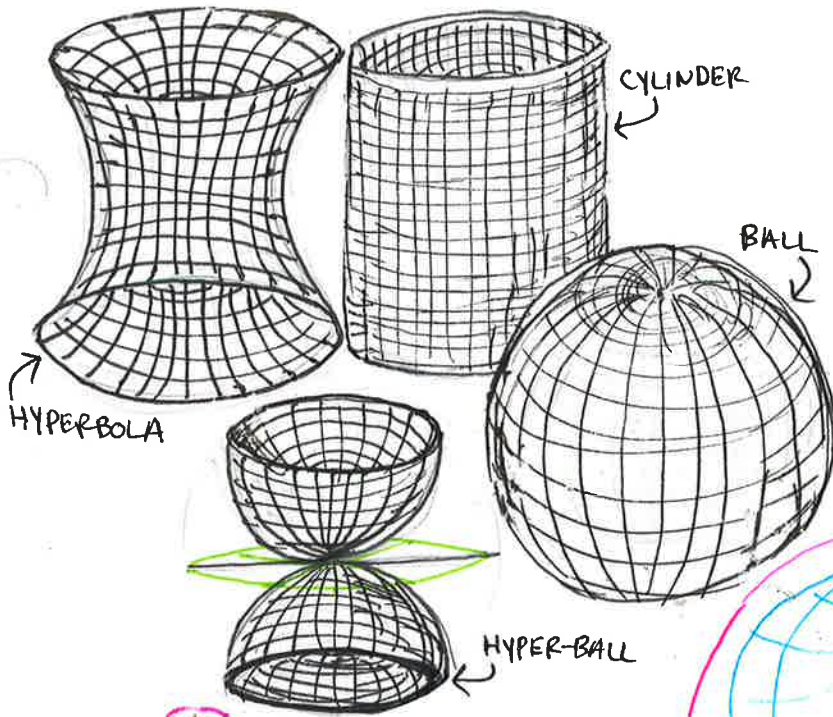

REVELATION 8:2

- 1000 ENLIGHTENMENT
- 700 BLISS
- 600 PEACE
- 540 JOY
- 500 LOVE
- 400 REASON
- 350 ACCEPTANCE
- 310 WILLINGNESS
- 250 NEUTRALITY
- 200 COURAGE
- 175 PRIDE
- 150 ANGER
- 125 DESIRE
- 100 FEAR
- 75 GRIEF
- 50 APATHY
- 30 GUILT
- 20 SHAME
- 10 PAIN

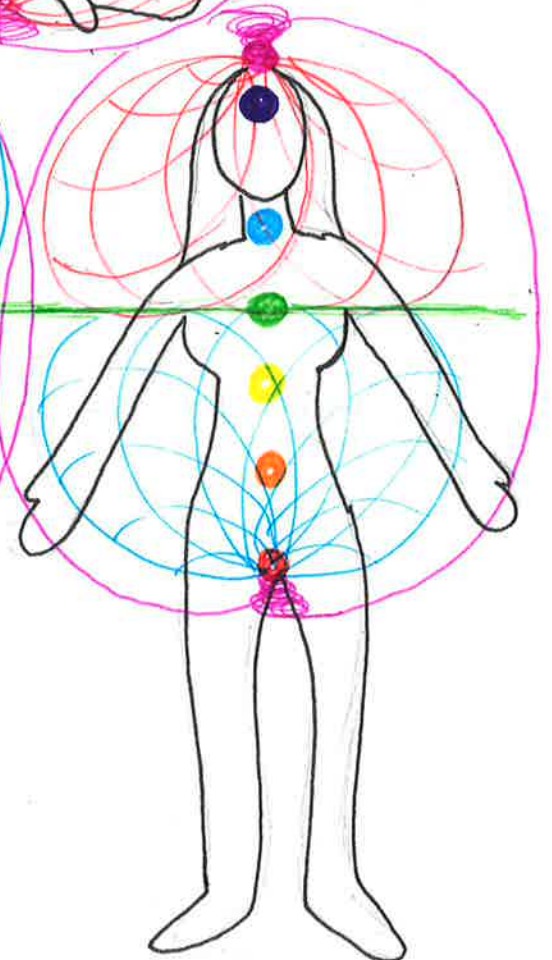
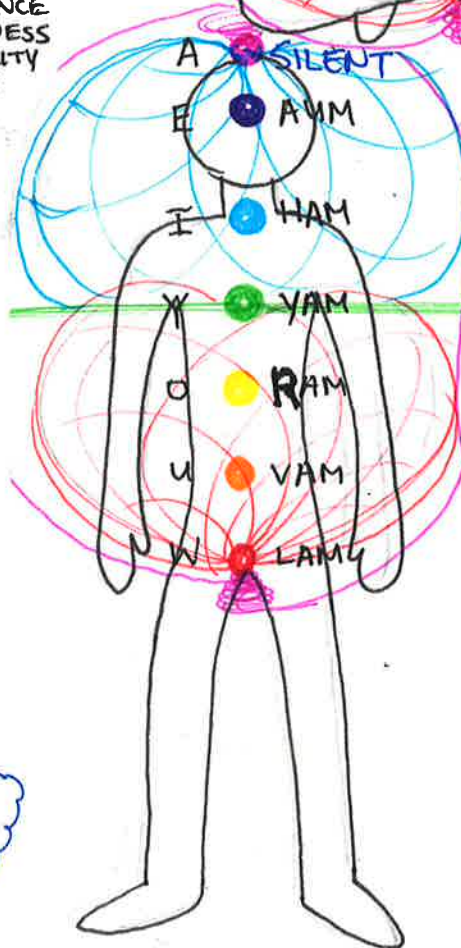
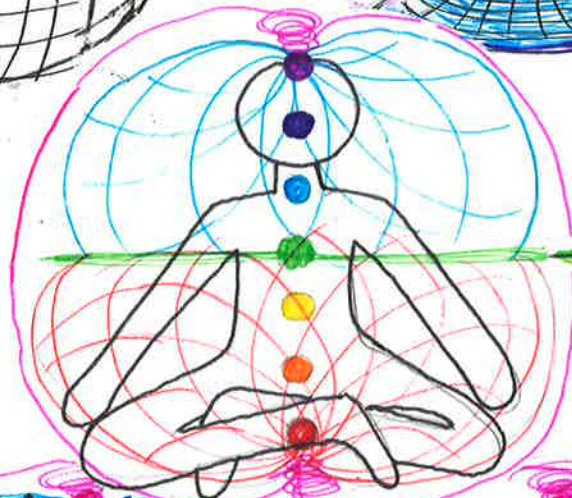

MEDIAL MESSIAL = MIDDLE

THE MESSIAH

THE MID SECTION OF THE BODY IS THE SPINE, THE CENTRAL NERVOUS SYSTEM, THE 7 ENDOCRINE GLANDS, THE 7 ENERGY CENTERS IN THE BODY.

7 CHAKRAS

Rev. 8:2 "WHEN THE 7TH SEAL WAS BROKEN THERE WAS SILENCE IN HEAVEN FOR 30 MINUTES"

IN MICHAELANGELO'S PAINTING "THE DREAM" AN ANGEL IS BLOWING A TRUMPET DIRECTLY TO THE MAN'S THIRD EYE.



(THE SERPENT IN THE TREE OF KNOWLEDGE)

**MATTHEW 26:34** "TRULY TRULY (JESUS SAYS) BEFORE THE ROOSTER CROWS YOU WILL DISOWN ME 3 TIMES."

**MATTHEW 10:16** "BEHOLD I SEND YOU FORTH AS SHEEP IN THE MIDST OF WOLVES. BE YE WISE AS SERPENTS AND AS INNOCENT AS DOVES."

**ISAIAH 14:29** "DO NOT REJOICE ALL YOU PHILISTINES BECAUSE THE ROD THAT SMOTE THEE IS BROKEN; FROM THE SERPENTS ROOT WILL SPRING FORTH A COCKATRICE."



**LUKE 10:18**

JESUS SAID TO THEM "I WATCHED SATAN FALL FROM HEAVEN LIKE A FLASH OF LIGHTNING."



**Rev. 12:7** And the Great Dragon was thrown down, That Ancient Serpent who is called the Devil and Satan, The Deceiver of the Whole World. He was thrown down to earth, and his angels were thrown down with him.

**2 Corinthians 11:14** FOR SATAN HIMSELF IS TRANSFORMED INTO AN ANGEL OF LIGHT.

ROOSTER - SON OF THE MORNING.

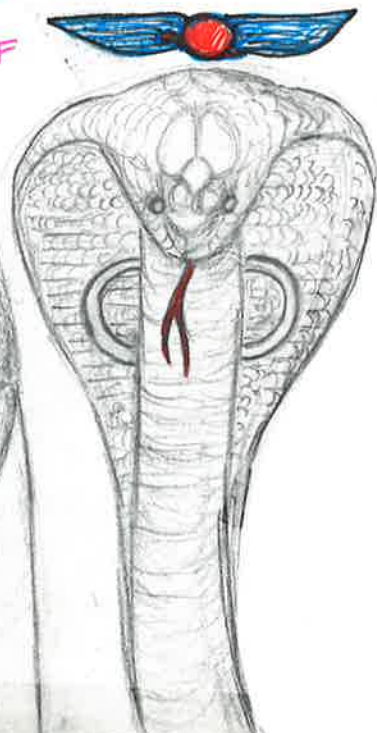

**ABRAXAS** THE FORCES OF LIFE & DEATH ARE LINKED TO THE FIERY SERPENT IN EDEN, AND THE FIERY SERPENTS ARE LINKED TO THE BRAZEN SERPENT OF MOSES, IT IS NOT GOD HIMSELF BUT MOSES WHO CRAFTS THE POLE. REMINDING US IT IS BY OUR OWN HAND, THAT THE SERPENT IS CONSTITUTED AS OUR FALL OR SALVATION. Carina del Valle Scarcke



○ ☽ ISIS  
THE HOLY SPIRIT- ▽  
I-ISIS

MER-LIGHT

○ ○ RA  
THE SON- ☆  
H-HORUS

KA-SPIRIT

○ † EL △  
THE FATHER-  
S-SET

BA-BODY

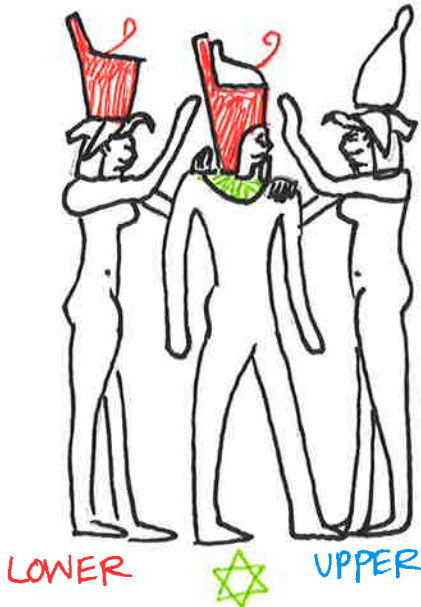

YESHUA = SALVATION

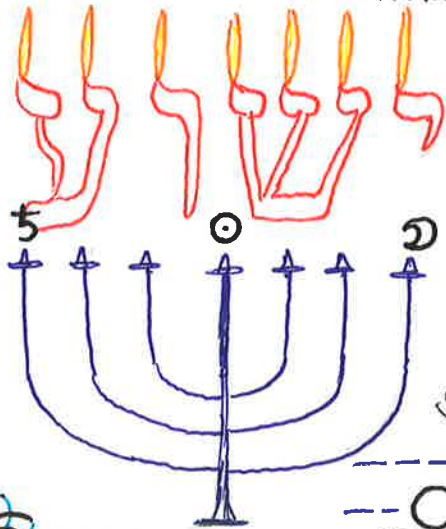

(SALVATION IS WITHIN)  
BY ALIGNING THE 7  
CHARAS, AND BECOMING  
WHOLE/HOLY, COMPLETE.  
YOU ARE THE SNAKE EATING HIS  
TAIL COILS

SOUL



MIND

BODY

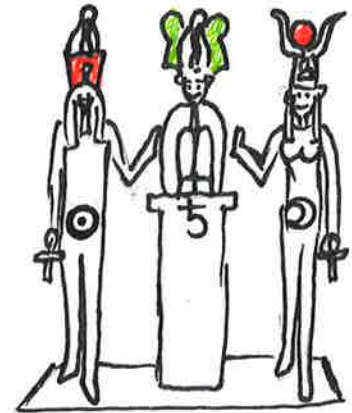
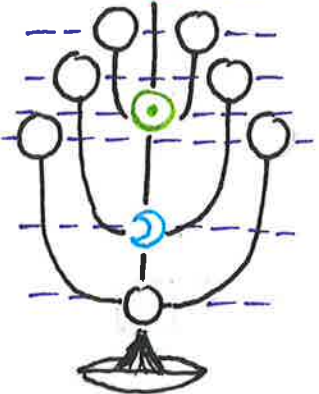
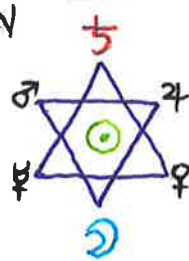

THE TAROT

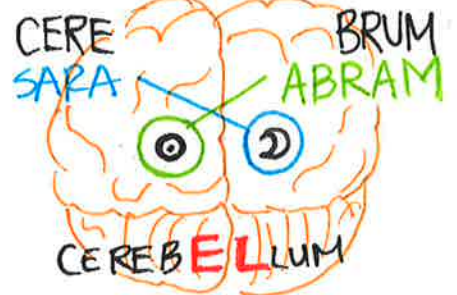

7 THE CHARIOT 7



SPIRO=BREATH RELIGIO=BIND

CHINESE SHU=TREE

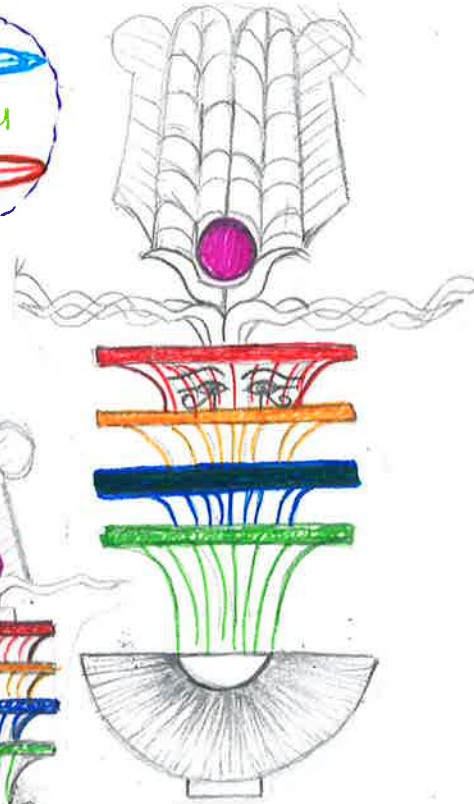
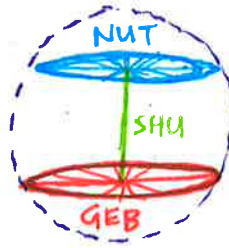

SEVERITY

MERCY

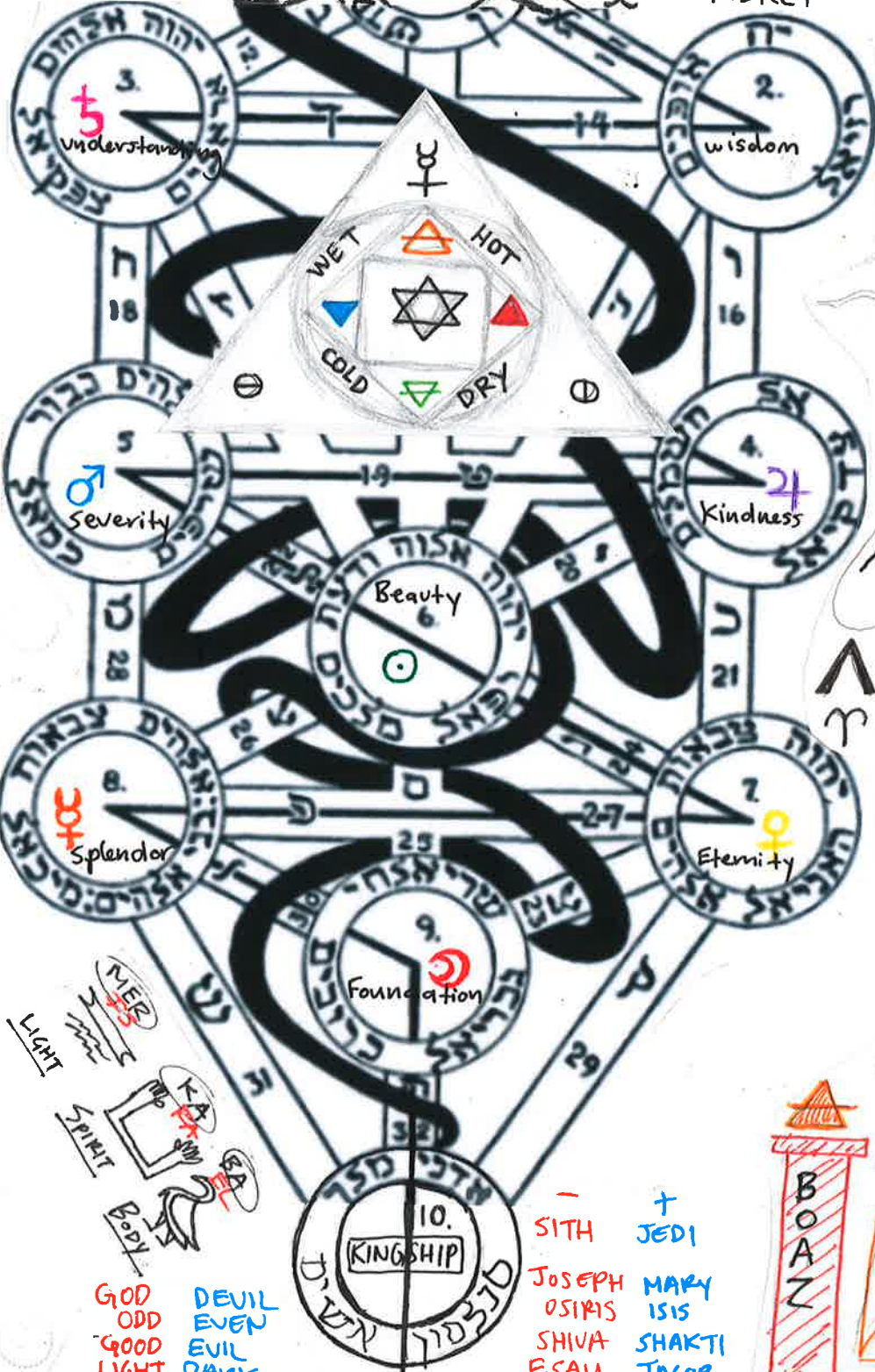

THE ORIGINAL PENTAGRAMMATION

TRUTH SPIRITUALITY  
Right Brain ♀  
 Feminine, Creative  
 Art, Passion, chaos  
 Expressional, Curves  
 Free Spirit

Left Brain ♂  
 Masculine, Statistical  
 Math, Logic, Rationality  
 Order, Practical  
 RELIGION BELIEF

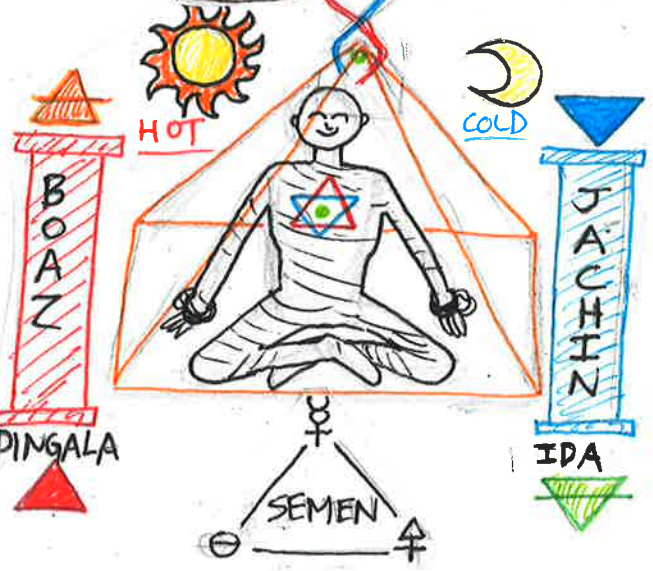
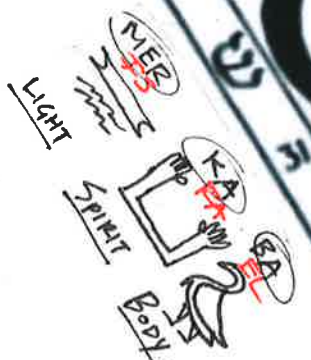

GOD ODD  
 GOOD LIGHT MORNING  
 DEVIL EVEN  
 EVIL DARK EVENING  
 DUALITY ~ POLARIZATION  
 POL-ICE

- SITH + JEDI  
 JOSEPH OSIRIS SHIVA ESAU CAIN  
 MARY ISIS SHAKTI JACOB ABLE  
 KRONOS TIME + RHEA SPACE



"The Aether is an Inseparable wholos of DiElectricity and Magnetism."  
-K.W.

THE SOURCE OF ALL CREATION

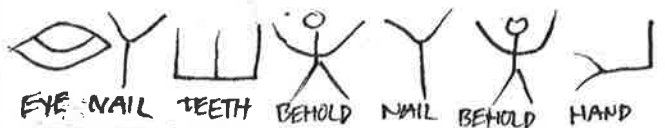

ROOT OF THINGS

ENLIGHTENED CONSCIOUSNESS

KNOWLEDGE OF GNOSIS

ANGELIC CHOIR

ASTRAL SUPER-NATURALNESS

SENSORY AWARENESS

MATERIAL CONSCIOUSNESS

ELEMENTS

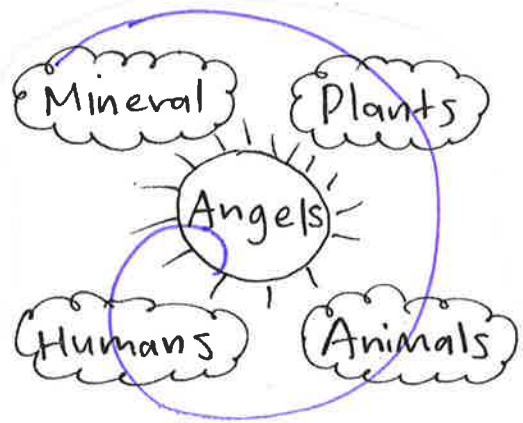
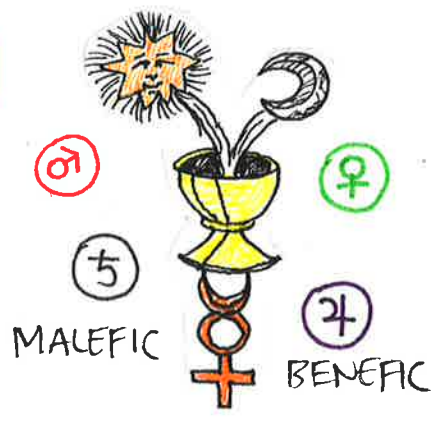
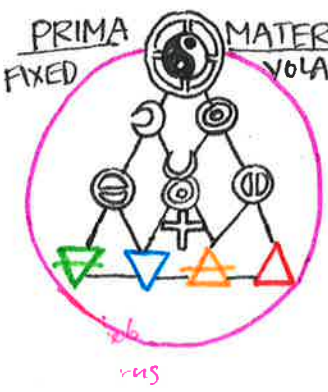
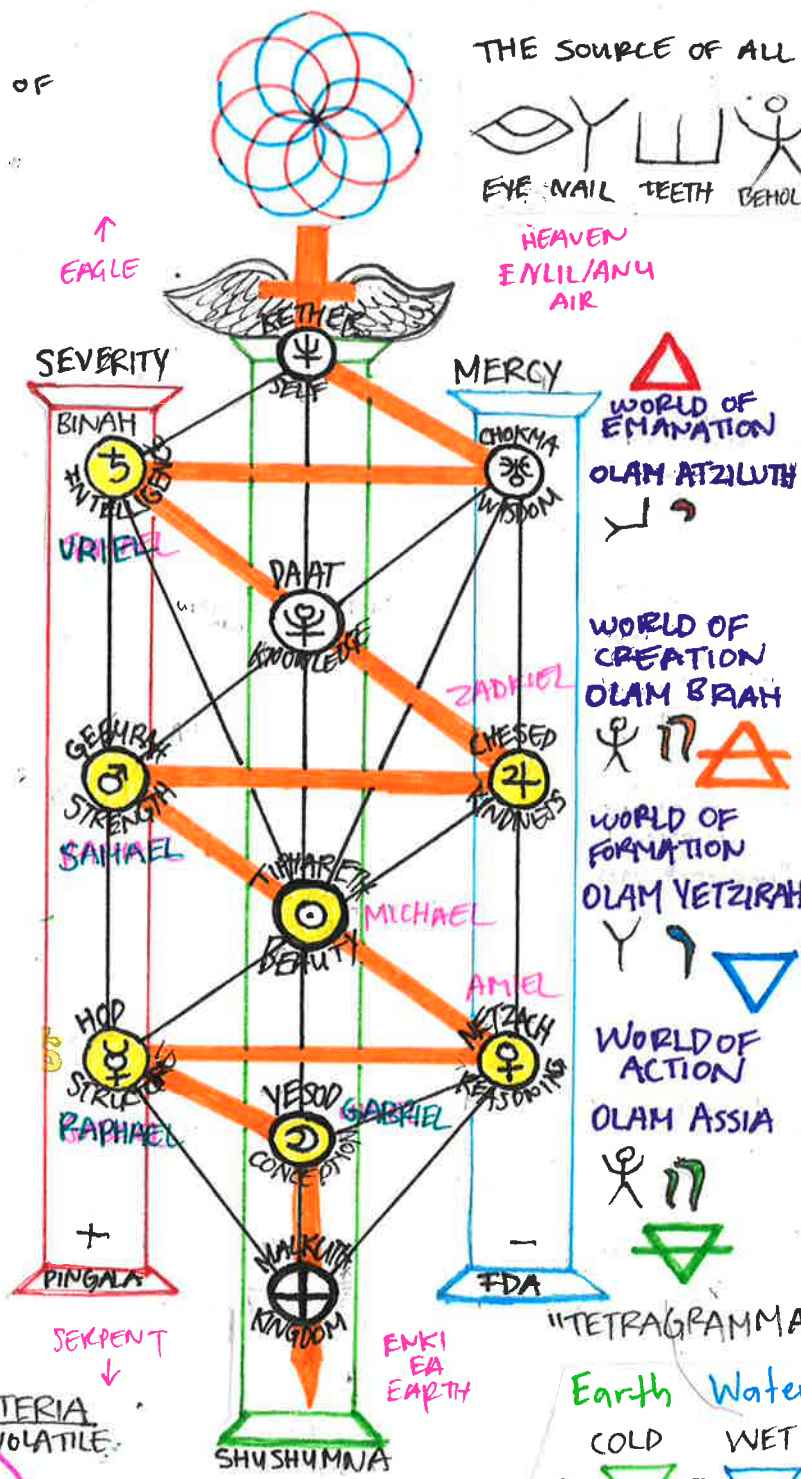





GEORGE WASHINGTON WAS A FREEMASON WHO LEAD THE WAR AGAINST BRITISH TYRANNY (DEATH) AND USHERED IN LIBERTY FOR THE NEW REPUBLIC (BIRTH)



Lat. Capitol 38. 53. N.  
Long. 0. 0.

AFTER GREENWICH WAS MADE THE WORLD MERIDIAN, D.C. AND PARIS BOTH RENOUNCED THEIR CLAIMS.

WHAT IS THE OBSESSION WITH THE PYRAMID AND THE ZERO MERIDIAN, WHICH RUNS THROUGH THE NATIONS CAPITOL CITY?



← MERIDIAN HILL PARK  
"HOUSE OF THE TEMPLE"  
THE GRAND LODGE FOR THE SUPREME COUNCIL OF SCOTTISH RITE OF FREEMASONRY - 1733 16<sup>ST</sup>

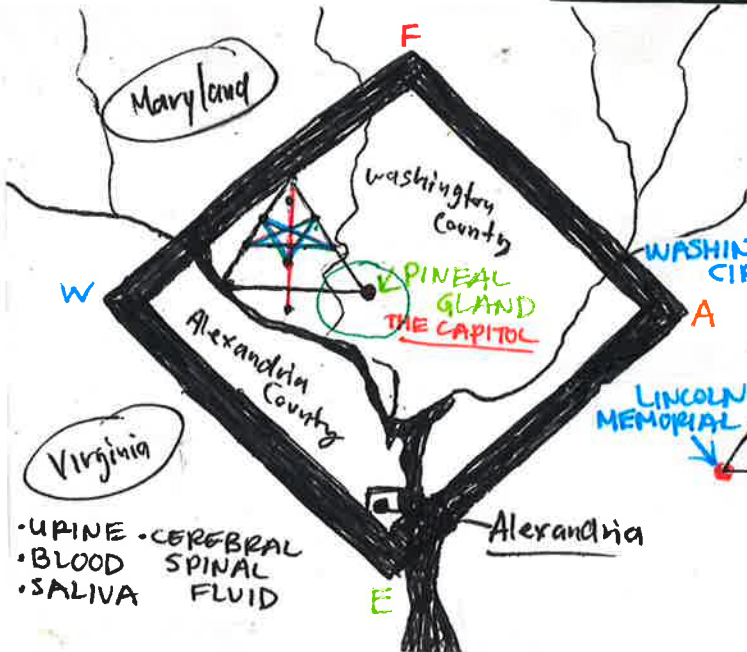

- UPINE • CEREBRAL
- BLOOD SPINAL
- SALIVA FLUID

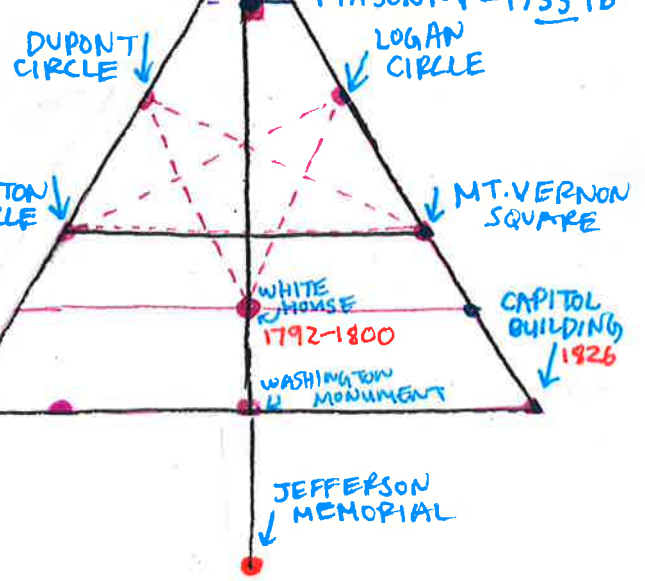



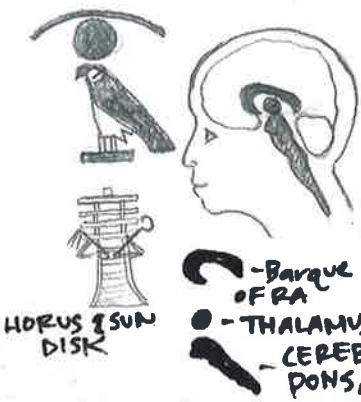
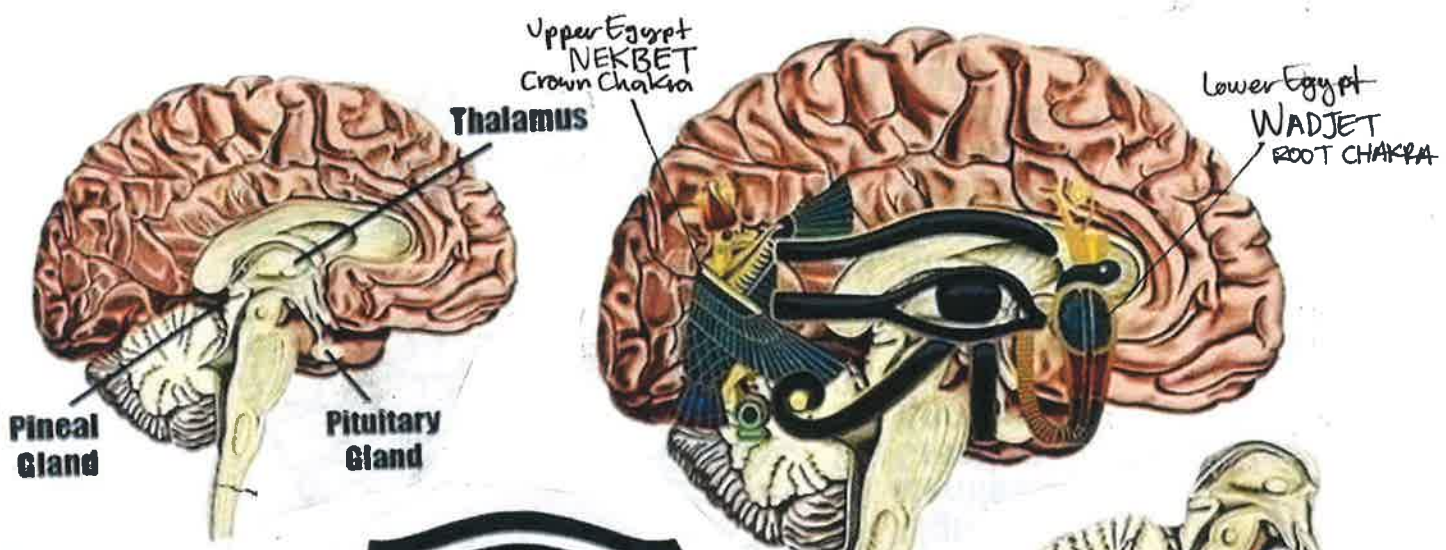

HORUS & SUN DISK

- Barque OF RA
- THALAMUS - RA'S SUN DISK
- CEREBRAL PEDUNCLE, PONS, MEDULLA OBLANGATA



The Eye of Horus



Inner Bird

THE EYE OF HORUS IS THE 3RD EYE, PROTECTED BY THE VULTURE & THE COBRA. (Feathered Serpent)

Falcon of Horus

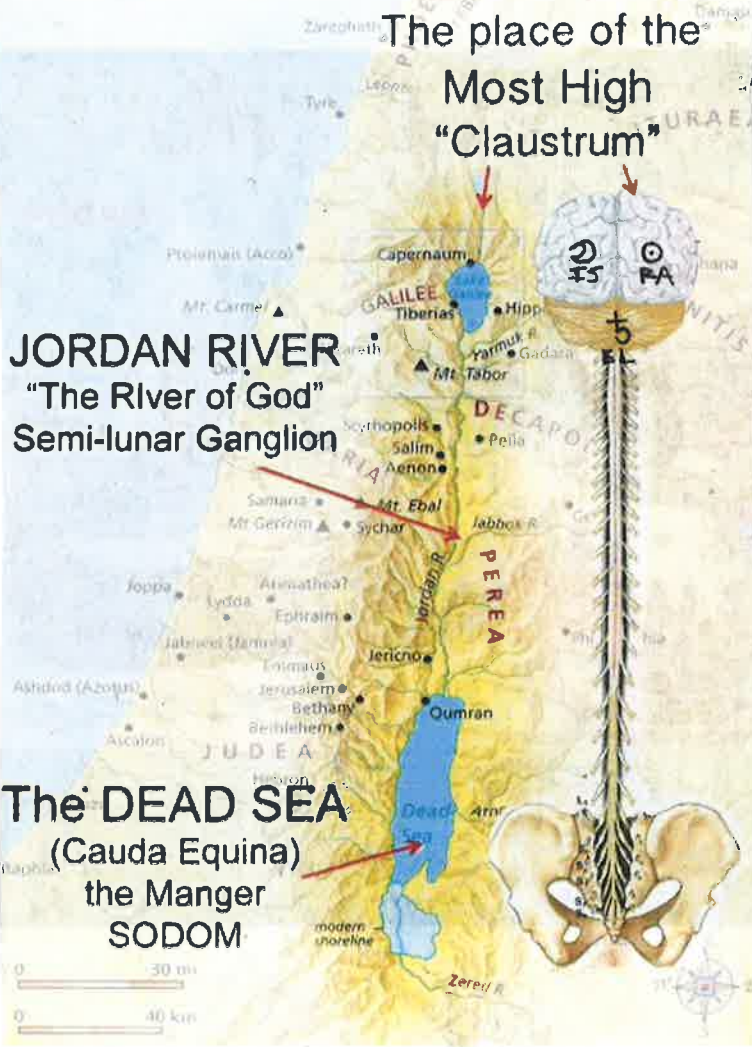

The place of the Most High "Claustrum"

JORDAN RIVER "The River of God" Semi-lunar Ganglion

The DEAD SEA (Cauda Equina) the Manger SODOM

As the Jordan River empties into the Dead Sea, so the spinal cord terminates in the section of anatomy known as 'Sodom' The region in which Josephus referred to as "The lake of Sodom".

Jesus was not a savior until he was 'Christed' (baptised or anointed) 'of' John (not 'by' John). John, or Ioannes, is the 'oil' or 'ointment'.

The sacred fluids from the claustrum one yellow and the other white is the milk and honey referred to in the bible. The children of IS-RA-EL having been given the promise of return to this land flowing with milk and honey.



"FATHER SKY"



GENESIS 6:4 "THE NEPHILIM WERE ON THE EARTH IN THOSE DAYS, AND ALSO AFTER THAT, WHEN THE SONS OF GOD CAME IN UNTO THE DAUGHTERS OF MEN, AND THEY BORE CHILDREN TO THEM."



"MOTHER EARTH"

CONSCIENCE

FORCE  
SPIRITUAL  
MIND

THOUGHT  
SPIRITUS

SPRIT

"I SHOULD"

MOON

FREQUENCY

MUTABLE



MAGNETISM

SUBCONSCIOUS



MERCURY



SPIRITUAL

MATERIAL

W

H



ACTION  
CORPUS

"I WANT"

VIBRATION

ELECTRICITY

UNCONSCIOUS



EARTH

BODY

FLESH

PHYSICAL

FORM

HARDWARE

FIXED

C

D

CARDINAL



SUN

SOUL

PSYCHE

PSYCHOLOGICAL

SOURCE

SOFTWARE

FEELING  
ANIMA

"I WILL"

ENERGY

DIELECTRICITY

CONSCIOUS



SUN

SOUL

PSYCHE

PSYCHOLOGICAL

SOURCE

SOFTWARE

SOFTWARE

SOFTWARE

SOFTWARE

SOFTWARE

SOFTWARE

SOFTWARE

SOFTWARE

SOFTWARE

SOFTWARE

SOFTWARE

SOFTWARE

SOFTWARE

SOFTWARE

PHILOSOPHER  
PRIEST  
KING

"He was called Hermes Trismegistus because he was a great philosopher, a great priest and a great king."

- Marsilio Ficino, 'THE PYRAMID'

QUEEN  
WHITE

KING  
RED

CHILD  
BLACK

SALT = STABILITY

SULFUR = COMBUSTABILITY

MERCURY = LIQUIDITY

THESIS  
PROBLEM

ANTITHESIS  
REACTION

SYNTHESIS  
SOLUTION

NIGRIFICATION - MELANOSIS

RUBIFICATION - IOSIS

CITRIFICATION - XANTHOSIS

ALBERICATION - LEVIOSIS

GENESIS 19:24 "THE LORD RAINED UPON SODOM AND GEMORAH BRIMSTONE AND FIRE FROM THE LORD OUT OF HEAVEN"

GENESIS 19:26 "BUT HIS WIFE LOOKED BACK FROM BEHIND HIM AND SHE BECAME A PILLAR OF SALT."



ODIN  
The High One

NOTE: ONE EYE  
ODIN = ONE  
RUSSIAN

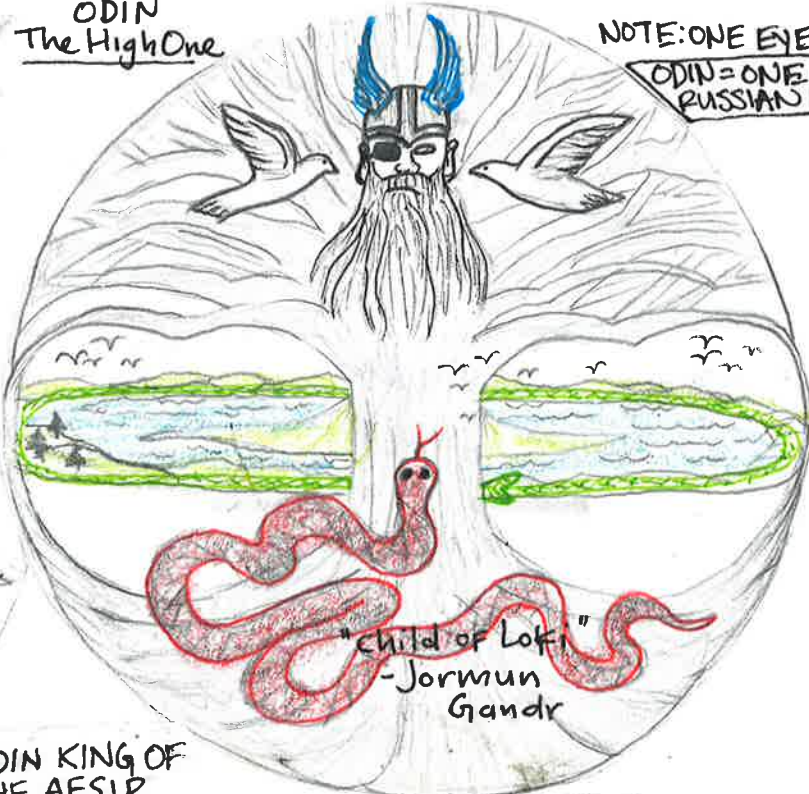
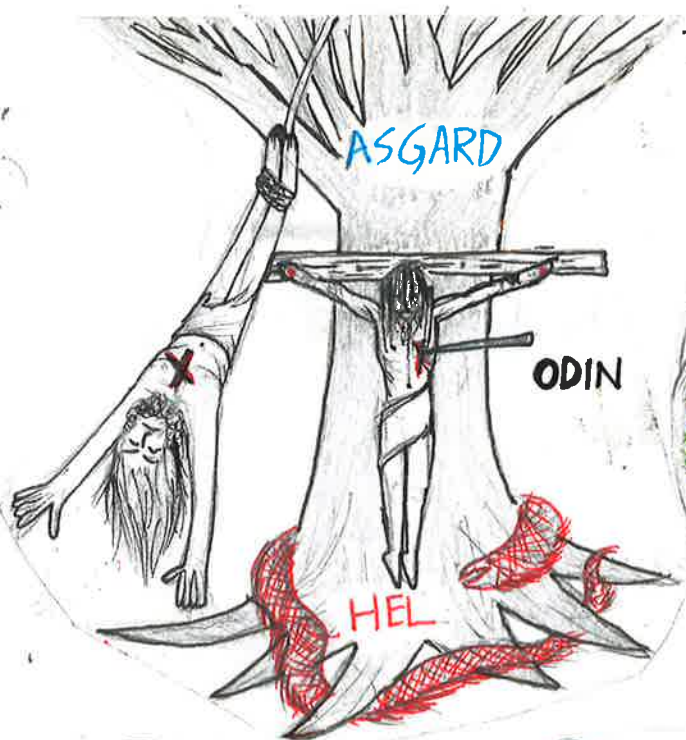

**YGGDRASIL** - NORSE MYTHOLOGY  
Tree of Life

**ASGARD** ODIN KING OF THE AESIR

**EGGDRASIL** - DBBD  
THE COSMIC EGG

THE SNAKE GOES UP THE TREE AND BECOMES AN EAGLE.

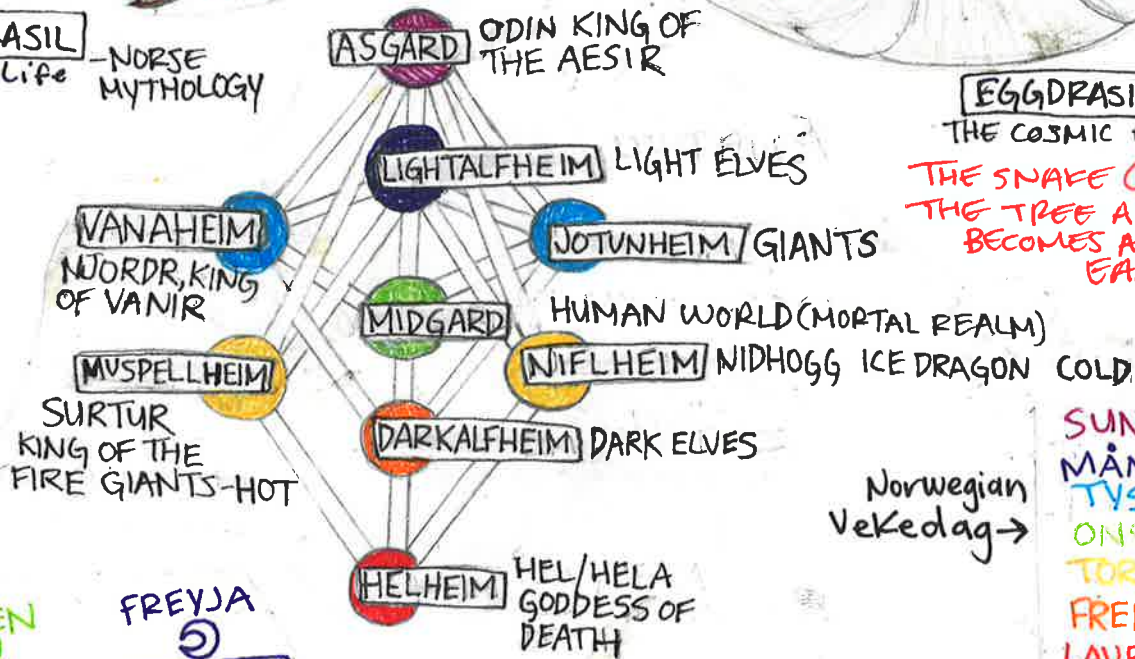

Norwegian  
VeKedag →

SUNDAG  
MÅNDAG  
TYSDAG  
ONSTAG  
TORSDAG  
FREDAG  
LAURDAG

WODEN

FREYJA

WODENS DAY

MOONDAY

FRIGGS DAY

5 BALDER  
SATURDAY

FRIGGA

THOR  
THOR DAY

SUNDAY  
FREYR

TIWSDAY  
TIW/TYR





YGGDRASIL



ASGARD

BIFROST BRIDGE

MIDGARD

NIFL-HEIM

LIGHT ALFHEIM

MUSPELLHEIM

VANAHEIM

DARK SVAR-TALFHEIM

JOTUNHEIM

HEL

HEAVEN

33

EARTH

HELL

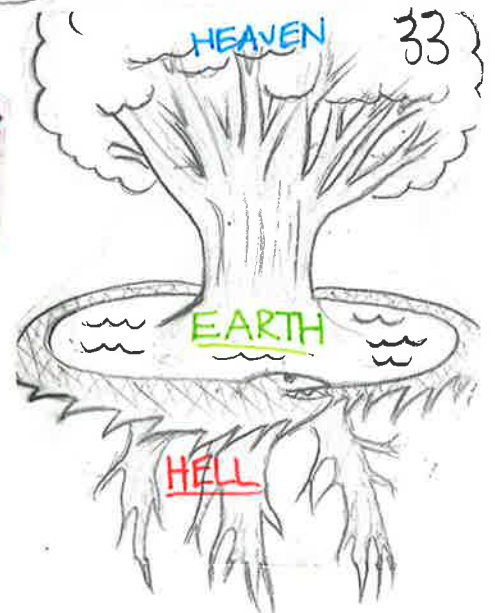
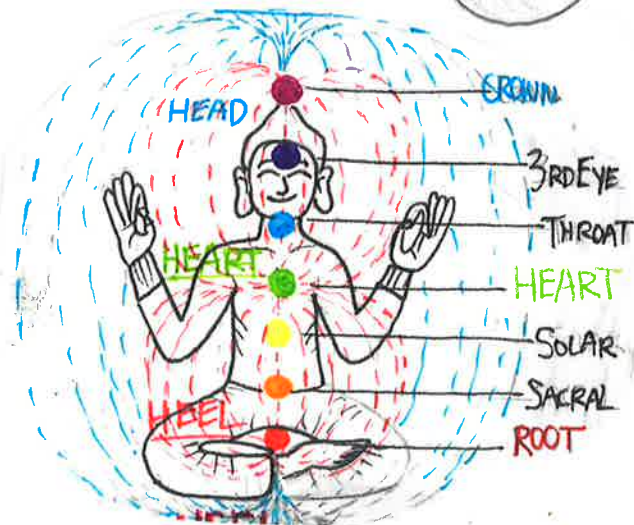



**POSITIVE**

- SAHASRARA - ILLUMINATION
- AJNA - DIVINE SIGHT
- VISHUDHA - DIVINE LOVE
- ANAHATA - DIVINE COGNITION
- MANIPURA - WILL POWER
- SVADISTHANA - REASON
- MULADHARA - MEMORY

GOD IS MAN  
- AWAKE -

- 5 MAGNETOSPHERE
- 4 EXOSPHERE
- 3 THERMOSPHERE
- 2 MESOSPHERE
- 1 IONOSPHERE
- ♀ STRATOSPHERE
- ♂ TROPOSPHERE

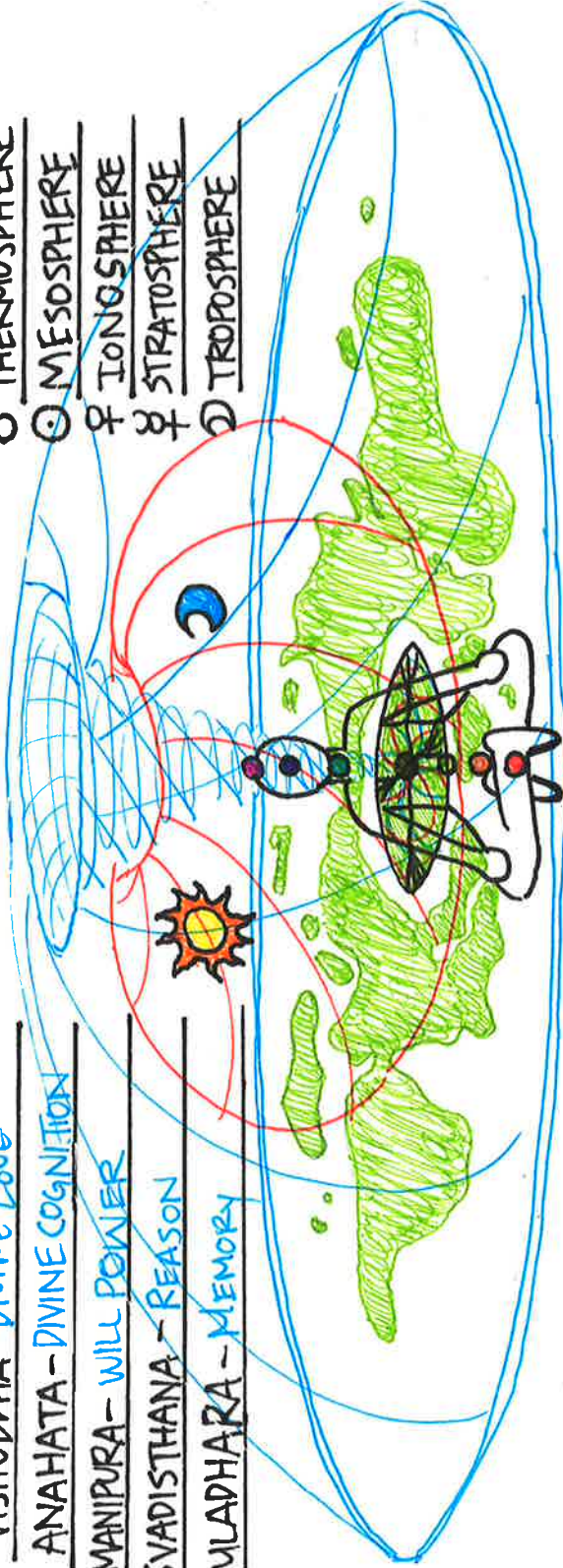

- ATALA - FEAR AND LUST
- VITALA - RAGING ANGER
- SUTALA - RETALIATING JEALOUSY
- TALATALA - PROLONGED CONFUSION
- RASATALA - SELFISHNESS
- MAHATALA - CONSCIOUSLESSNESS
- PATALA - MALICE/MURDER

MAN IS GOD  
- ASLEEP -

Earth Heals when She  
Sings.... Be Silent...  
So you can Listen!...  
-DBBD

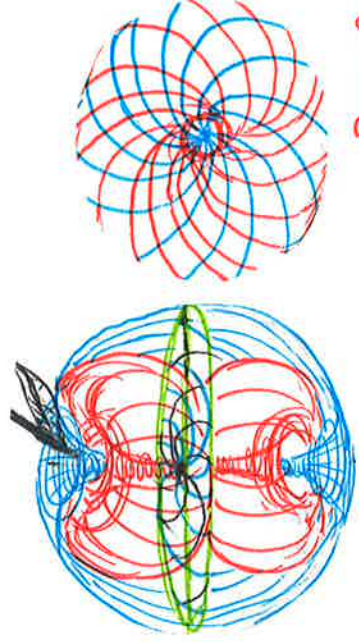

- BOOK RECOM.  
**GARY OSBORN**  
- The Serpent Grail  
- The Shining Ones

PSALM 14:1 "THE FOOL SAYS IN HIS HEART, THERE IS NO CREATOR!"



**1871 GEORGE AIRY'S FAILURE** - FAILED TO DETECT MOTION OF THE EARTH. THE STARS ABOVE MOVE RELATIVE TO A FIXED STATIONARY EARTH BELOW. BY FIRST FILLING A TELESCOPE WITH WATER TO SLOW DOWN THE SPEED OF LIGHT INSIDE THEN CALCULATING THE TILT NECESSARY TO GET THE STARLIGHT DIRECTLY DOWN THE TUBE, AIRY UNINTENTIONALLY DEMONSTRATED THAT THE EARTH WAS FIXED HORIZONTALLY SINCE THE STARLIGHT CAME IN AT THE CORRECT ANGLE WITHOUT NEEDING TO CHANGE THE TILT OF THE TELESCOPE. HE DID NOT HAVE TO CHANGE THE ANGLE OF THE TELESCOPE BECAUSE THE AETHER DRIFTS OVER THE SURFACE OF THE EARTH.

**THE TET OR DJED PILLAR** - IS THE OLDEST SYMBOL OF OSIRIS AND WAS GREAT SIGNIFICANCE TO THE ANCIENT EGYPTIANS. ITS THE SYMBOL OF OSIRIS BACKBONE AND HIS BODY IN GENERAL. PTAH WAS DESCRIBED AS THE NOBLE DJED AND IS SOMETIMES HOLDING THE DJED AS A STAFF. THROUGHOUT ANCIENT EGYPT THE COMMON BELIEF WAS THAT SEMEN WAS REPRODUCED IN THE SPINAL FLUIDS, HENCE THE SYMBOL OF THE ERECT SPINE AS A REPRESENTATION OF COSMIC REGENERATION. THE PRACTICE CONTINUED WITH HINDUISM TRADITIONS OF KUNDALINI ENLIGHTENMENT AND AWAKENING THE FIRE SERPENT, WHICH RESIDES IN THE CHAKRAS. OVERTIME THE DJED PILLAR WAS KNOWN TO REPRESENT STABILITY AND PERMANENCE LIKE THE ANKH AND THE WAS SCEPTER.

**THIS WORLD IS NOT OUR HOME.**

THE SPINE IS THE HIGHWAY TO THE INFINITE, YOUR OWN BODY IS THE TEMPLE OF GOD, IT IS WITHIN YOUR OWN SELF THAT CHRIST MUST BE RAISED.

**WE ARE NOT BOUND TO THIS WORLD.**

THE GOD CONSCIOUSNESS IS THE FREQUENCY THAT EXISTS WITHIN OURSELVES, PART OF OUR MISSION ON EARTH IS TO MASTER OUR THOUGHTS, VIBRATIONS AND FREQUENCIES SO THAT WE CAN MOVE THROUGHOUT LIFE WITH EASE. **WE ARE NOT LIMITED TO THIS REALITY.**

WHEN THE EGO BECOMES LESS, GODS PRESENCE IS IMMENSE!

**GOD IS MAN AWAKE, MAN IS GOD ASLEEP!**

THE UNIVERSE IS A COSMIC BEING WHOSE BODY IS ELEMENTAL AND WHOSE MIND IS SPIRITUAL.

NORDIC	BABYLON	EGYPT	HEBREW	INDIA	GREECE
FREYERÖ	SHAMASH-UTU	HORUS	MICHAEL	SURYA	POSEIDON
FREYA	SIN-NANNA	ISIS	URIEL	CHANDRA	OURANOS
ODIN	NEBO-NABU	PTAH	GABRIEL	MANGALAO	HADES
THOR	NERGAL	THOTH	RAPHAEL	BUDDA	KRONOS
FRIGGA	MARDUK	OSIRIS	AMIEL	GURU	ZEUS
SURTUR	ISHTAR-INANNA	RA	ZADKIEL	SUKRA	ARES
TYR	ENKI-EA	MAAT	SAMIEL	SHANI	HERMES
	ENLIL	GEB		RAHU	APOLLO
	ANU	NUT		KETU	AFRODITI
	KI			BUMANDALA	ARTEMIS
					GAIA

REVI:20 THE MYSTERY OF THE 7 STARS WHICH THEE HAS SAW IN MY RIGHT HAND AND THE 7 CANDLESTICKS. THE 7 STARS ARE THE 7 ANGELS OF THE 7 CHURCHES. AND THE 7 CANDLESTICKS ARE THE 7 CHURCHES.

"I AM THE VINE  
YOU ARE THE  
BRANCHES."  
JOHN 15:5

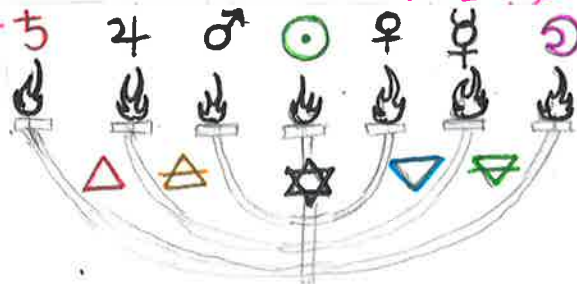



82 ALFREDO BOWMAN 1933-2016

DR. SEBI CURED AIDS WITH NATURAL HERBS AND (U.T.) or URINE THERAPY, BY FIRST HAVING HIS PATIENTS SWITCH TO AN ALL NATURAL HERBAL LIFESTYLE <sup>(30 DAYS)</sup>, THEN BY CONSUMING FRESH MORNING URINE <sup>(30 DAYS)</sup>, ONCE THE BLOOD IS PURIFIED BY NATURAL FOODS, THE URINE BECOMES LESS CONTAMINATED AND SATURATED WITH WASTE, TOXINS & FOREIGN MATTER. AGED URINE (FERMENTED URINE) IS VERY HIGH IN POTENTIAL OF HYDROGEN OR (PH) WHICH IS BASIC/ALKALINE AS OPPOSED TO BEING ACIDIC.

DR OTTO HEINRICH WARBURG, WINNER OF THE 1931 NOBEL PRIZE IN PHYSIOLOGY DISCOVERED THE CAUSE OF CANCER IN 1923. "CANCER GROWS IN OXYGEN DEPRIVED ACIDIC TISSUE. DIS-EASES CAN NOT SURVIVE IN AN ALKALINE BODY." CANCEROUS TISSUES ARE ACIDIC, WHEREAS HEALTHY TISSUES ARE ALKALINE.

"DEPRIVE A CELL 35% OF ITS OXYGEN FOR 48 HOURS AND IT MAY BECOME CANCEROUS."

DISEASES, BACTERIAS AND CANCERS LOVE ACIDIC ENVIRONMENTS BECAUSE THEY CAN LIVE IN IT. ALL FOODS ON DR SEBI'S NUTRITIONAL GUIDE ARE RECOMMENDED BECAUSE THEY ARE ALL ALKALINE FORMING FOODS. ALCOHOL AND ALL MEAT ARE VERY ACIDIC AND WILL ENCOURAGE NEGATIVE RESULTS TO THE BODY'S PHYSICAL, SPIRITUAL, AND PSYCHOLOGICAL HEALTH, AS WELL AS ENCOURAGE THE SPREAD, GROWTH AND DEVELOPMENT OF DISEASES BACTERIAS AND CANCERS WITHIN THE BODY. CHEMOTHERAPY USES DANGEROUS CHEMICALS TO DESTROY CANCER IN THE BODY, RADIATION THERAPY USES DANGEROUS HIGH ENERGY BEAMS SUCH AS X RAYS TO DESTROY CANCER THAT IS NOT WANTED IN THE BODY.

WE CAN HEAL EACH OTHER BY RADIATING LOVE FROM OUR BODIES TO THE ILL IN ORDER TO ELIMINATE CANCER WITHOUT HURTING THE BODY AND PREVENT HAIR LOSS.

DOWNLOAD DR SEBI'S NUTRITIONAL GUIDE YT: TY'S CONSCIOUS KITCHEN



THE PITUITARY GLAND IS NEARLY SURROUNDED BY BONE AS IT RESTS IN THE STELLA TURCICA A DEPRESSION IN THE SPHENOID AND IS CONNECTED TO THE HYPOTHALAMUS OF THE BRAIN BY A SLENDER STALK CALLED INTUNDIBULUM.

THE PINEAL GLAND IS NEAR THE CENTER OF THE BRAIN IN A GROOVE BETWEEN THE 2 HEMISPHERES.

OPTIC THALAMUS (PTAH'S LAMP)

REVELATION 21 "THE CITY SHALL NOT NEED A SUN, FOR THE LAMB SHALL BE ITS LAMP."

MATHEW 6:22 "THE LIGHT OF THE BODY IS THE EYE; IF THEREFORE THINE EYE BE SINGLE, THY WHOLE BODY SHALL BE FULL OF LIGHT."  
-JESUS CHRIST

THE PANCREAS: IS THE LARGEST ENDOCRINE GLAND AND ITS FOUND IN YOUR BELLY. THE PANCREAS MAKES SEVERAL HORMONES INCLUDING INSULIN.

INSULIN IS THE "HORMONE THAT IS ESSENTIAL FOR LIFE!" BIOLOGY.  
IT REGULATES MANY METABOLIC PROCESSES THAT PROVIDE CELLS WITH NEEDED ENERGY, UNDERSTANDING, OR "INNERSTANDING", WHAT INSULIN DOES AND HOW IT EFFECTS THE BODY IS IMPORTANT TO YOUR OVERALL HEALTH.

CORONA VIRUS FEVER IS HIGH, COUGH DOESNT HAVE PHLEGM, TROUBLE BREATHING, BIG BREATHS; RESPIRATORY DISTRESS, •FATIGUE, •DIARRHEA, NAUSEA, -PRIOR TO FEVER.

PNEUMONIA - CAUSES RESPIRATORY DISTRESS, LUNGS FILL WITH FLUIDS OR PUS, SYMPTOMS INCLUDE COUGH OR CHILLS, PHLEGM, FEVER AND DIFFICULT BREATHING.

5G 60 TO 66 GIGAHERTZ FREQUENCY  
- 5G TOWERS EMIT HIGH FREQUENCY, (MM) MILLIMETER WAVES THAT CAUSE THE HEMOGLOBIN IN OUR BLOOD UNABLE TO BIND TO OXYGEN PROPERLY.

SYMPTONS INCLUDE "SHOCK STATE" OF INSUFFICIENT BLOOD FLOW, OF THE TISSUES DUE TO PROBLEMS WITH THE CIRCULATORY SYSTEM.

- ACUTE CARDIAL INJURY • ACUTE RESPIRATORY DISTRESS SYNDROME 61!
- SHORTNESS OF BREATHING.

A-TONE-MENT  
A-TUNE-MENT  
AT-ONE-MENT  
TONE = NOTE

TUNE | MUTE

TON-GUE { LINGUA  
TON-SILS { LANGUAGE

THE SKIN IS THE HUMAN BODYS LARGEST ORGAN. ITS NOT INTERNAL LIKE THE BRAIN OR HEART. ADULTS CARRY 8 POUNDS, 3.6 KG AND 22 SQ FT OF IT.

THE EGG IS THE LARGEST CELL IN THE HUMAN BODY, AND THE SPERM CELL IS THE TINIEST CELL IN THE HUMAN

360  
JOINTS  
IN THE  
HUMAN  
BODY!

GROUNDING ✓  
SUNGAZING ✓  
SUNBATHING ✓  
NATURAL ALKALINE FOODS ✓  
URINE THERAPY ✓

ACIDOSIS OF THE BLOOD = LACK OF OXYGEN. WHEN THERE IS LITTLE OXYGEN IN THE BLOOD, LIVER BECOMES DAMAGED. • CARBON DIOXIDE AND OTHER GASES BECOME HIGHER.



**DR. MORSE** - BLOOD AND CHLOROPHYL ARE THE LIQUID NECTARS OF LIFE. THEY ARE THE LIFE CONDENSED INTO NUTRIENTS, FUELS, BUILDING AND REPAIR MATERIALS. WITHOUT THEM, PLANTS, ANIMALS AND HUMANS WOULD COME TO AN END. ALL NATURAL CREATURES HAVE SOME SORT OF BLOOD, OR LIFE FORCE THAT SUSTAINS THEIR PHYSICAL BODY.

**ALCOHOL** - DESTROYS THE BRAIN, HEART, KIDNEYS, LIVER AND PANCREAS.  
- THE LIVER PRODUCES CHOLESTEROL, THE PANCREAS PRODUCES INSULIN WHICH IS ESSENTIAL FOR LIFE. IT REGULATES MANY METABOLIC PROCESSES THAT PROVIDES CELLS WITH NEED ENERGY.

**CHLOROPHYL** BUILDS AND REVITALIZES HUMAN BLOOD CELLS | REJUVINATES THE BODY AT THE CELLULAR LEVEL.

**THE 3 WISE MEN** - THE PINEAL, THE PITUITARY AND THE THALAMUS.

**THE PINEAL** SECRETES MELATONIN THAT REJUVINATES NEW BLOOD CELLS, AND REVERSES THE AGING PROCESS AS WELL AS KEEPS SYSTEMS FROM SHUTTING DOWN.

**THE PITUITARY** SECRETES SERATONIN, A NATURAL MOOD STABILIZER AND MAKES THE BODY FEEL HAPPY. IT STOPS BLEEDING, ELIMINATES DEPRESSION, HEALS WOUNDS, REMOVES TOXINS BY CONTROLLING OUR BOWLS, AIDS IN SLEEP, REGULATES APPETITE & DIGESTION.

**THE THALAMUS** PRODUCES DOPAMINE, IF ITS BEING WASTED OR NOT PRODUCED DUE TO OBSTRUCTION AND UNHEALTHY HABITS, THE RESULTS INCLUDE, BI-POLAR, ANOREXIA, OLD AGING, PTSD, MENTAL DISORDER, SCHIZOPHRENIA, DEMENTIA, DEPRESSION, ANXIETY, ADDICTION, CLAUSTROPHOBIA, ALL FROM LACK OF DOPAMINE.

**PSALM 45:7** "YOU LOVE RIGHTEOUSNESS AND HATE WICKEDNESS. GOD HAS ANOINTED YOU WITH THE OIL OF GLADNESS ABOVE YOUR FELLOWS."

**SEMEN RETENTION**

**PSALM 23:5** "YOU PREPARE A TABLE FOR ME IN THE PRESENCE OF MY ENEMIES, YOU ANOINT MY HEAD WITH OIL, MY CUP RUNNETH OVER. (Cover flows)"

**PROVERBS 21:20** "THERE IS OIL IN THE HOUSE OF THE WISE."

**MATTHEW 25:1** "KEEP YOUR LAMP FILLED WITH OIL, THE KING OF KINGS IS COMING."

**MATTHEW 6:22** "THE EYE IS THE LAMP OF THE BODY, IF THE EYE IS TO BE MADE SINGLE, THY WHOLE BODY SHALL BE FULL OF LIGHT."

**PSALMS 92:10** "BUT MY HORN IS LIFTED UP LIKE THE HORN OF THE OX, THE BEST OIL IS FLOWING ON MY HEAD."

**SAMUEL 16:13** "THEN SAMUEL TOOK THE HORN OF OIL AND ANOINTED HIM, IN THE MIDST OF HIS BRETHERN AND THE SPIRIT OF THE LORD CAME UPON DAVID FROM THAT DAY FORWARD."

**ACTS 1:8** "YOU SHALL RECIEVE POWER WHEN THE HOLY SPIRIT COMES UPON YOU."

**JOHN 1:51** JESUS - "TRULY TRULY I SAY TO YOU, YOU WILL ALL SEE HEAVEN OPENED AND THE ANGELS OF GOD ASCENDING AND DESCENDING ON THE SON OF MAN, THE ONE WHO IS THE STAIRWAY BETWEEN THE HEAVEN AND EARTH."

**1 TIMOTHY 2:5** "FOR THERE IS ONE GOD AND ONE MEDIATOR BETWEEN GOD AND MEN, THE MAN JESUS CHRIST."

**COLLOSSIANS 1:26** "THE MYSTERY THAT HAS BEEN HIDDEN FOR AGES AND GENERATIONS PAST BUT NOW HAS BEEN MADE MANIFEST TO HIS SAINTS TO WHOM GOD WOULD MAKE KNOWN WHAT IS THE RICHES OF THE GLORY OF THIS MYSTERY AMONG THE GENTILES WHICH IS CHRIST IN YOU; THE HOPE OF GLORY."

HEMOGLOBIN HAS IRON = RED  
CHLOROPHYL HAS MAGNESIUM = GREEN

**MATTHEW 2:1**  
WHEN JESUS WAS BORN THERE CAME WISE MEN FROM THE EAST, WHERE IS HE THAT IS BORN KING OF THE JEWS? WE HAVE COME TO WORSHIP HIM.

THE MIND CONVERTS THE BODY TO THE SOUL.  
JOHN 1:9 "JESUS SAITH VNTU HIM I AM THE WAY, THE TRUTH AND THE LIFE, NO MAN COMETH VNTU MY FATHER BUT BY ME."



THE KABBALAH STATES BEFORE HUMANS THE ADAM KADMON' OR HEAVENLY HUMAN WHO IS THE TOTALITY OF THE SEPHIROTH, THE ANDROGYNOUS COSMIC BEING OR 'MACRO-ANTHROPOS' THE PRIMEVAL SOUL; WAS THE SPIRITUAL REFLECTION OF THE DIVINE CREATOR. ADAM & EVE CREATED AS A PHYSICAL REFLECTION OF THE ADAM KADMON.

WE CAN WORK WITH THE ENERGIES OF KABBALISTIC TREE OF LIFE TO ACCESS THE SPIRITUAL FORCES OF CREATION; THE ADAM KADMON IS THE DIVINE HUMAN MATRIX, ACTIVATE THE GOD OR DIVINITY CODE BY THE INTEGRATION OF THE 3 ASPECTS OF THE HUMAN BODY; THE PHYSICAL BODY, THE SOUL BODY & THE SPIRITUAL BODY.

IN OTHER MYTHS OF CREATION IT IS SAID THAT THE TARCHONS FORMED AN EARTHLY ADAM TO FULFILL THEIR SEXUAL DESIRES, AS THEY WERE FEMALE. - THE HUMAN RACE IS JUST AVATARS FOR SPIRIT.

↓  
THE UNIFIED FIELD SEPERATED TO REDUCED VERSIONS, FROM ALL OF COMPLEXITY TO MORE SIMPLIFIED VERSIONS OR MINIATURE VERSIONS WITH THE SAME COMPLEXITY. - MAN IS MADE IN GODS IMAGE, AND NOT MADE w/ 2 HANDS; BUT SPECIFICALLY WITH SOUND. "GOD SAID LET THERE BE LIGHT" - ALSO WHEN JESUS CAME TO BE "THE WORD WAS MADE FLESH AND HE PITCHED HIS TENT AMONG US."

THE WORLDS SPIRITUAL TEACHINGS - TELL US THAT "GOD" SEEKS ONENESS, UNITY & CONNECTION. THE FUNDAMENTAL QUALITY OF THE AETHER IS LOVE & LIGHT AND SINCE NATURE IS LOVING, IT SEEKS TO HAVE EVERYONE FEEL THE SAME WAY. IT IS CONTINUALLY STRIVING TO HAVE EACH CONSCIOUS LIFE FORM THE UNIVERSE REUNITE WITH LOVE & LIGHT AS MUCH AS POSSIBLE. THEREFORE GOD IS EVOLVING THROUGH THE FREE WILL DECISIONS OF ITS APPARENTLY SEPERATE PARTICIPANTS.

# THE QABBALAH

MER=LIGHT Mercury KA=SPIRIT caduceus BA=BODY Balance

**D.N.A** - DIVINE NATURAL GREEN=ENERGY ACTIVATION

ACTIVATE YOUR NATURAL DIVINITY ~

"KEEP YOUR EYES SIMPLE!"

MATTHEW 6:22 "THE LIGHT OF THE BODY IS THE EYE, IF THEREFORE THINE EYE WERE TO BE MADE SINGLE, THY WHOLE BODY SHALL BE FULL OF LIGHT."  
- JESUS

**APOPHASIS** APOPHATIC INQUIRING

TO SAY WHAT SOMETHING ISNT, USING DEDUCTIVE REASONING, LOGIC & CRITICAL THINKING, RESULTING IN TRUTH DISCOVERY; ARRIVING AT KNOWLEDGE. - HOW TO FIND A NEEDLE IN A HAY STACK, BURN THE HAY, IT WILL BE REVEALED IN THE END.

KEN WHEELER @THEORIA Apophasis "TODAYS CURRENT BRANCH OF SCIENCE IS BASED UPON PARTICULISM, (THE CULT OF BUMPING PARTICLES) THAT ALL INTERACTIONS IN THE UNIVERSE CAN BE QUANTIFIED, QUANTUM MECHANICS IS A MATERIALISTIC MINDSET, ITS ATOMISTIC. THAT THERE MUST BE SOMETHING PHYSICAL THERE. THE IDEA OF A VIRTUAL PHOTON PASSING THROUGH A LIGHT-BULB IS HILARIOUS!"

THESE ARE NOT SCIENTISTS THEY'RE MATH MATICIANS AND IF THEY SAY SOMETHING IS A MIRACLE, THEY'RE A PRIEST! -LMAO

S/O @BroSanchezTV  
YouTube ↑



**JOHN 4:24** "GOD IS SPIRIT."

AYN = ABSOLUTE  
 AYN SOF = BOUNDLESSNESS  
 AYN SOF AUR = BOUNDLESS LIGHT

**HEBREWS 13:8** "HE IS THE SAME YESTERDAY, TODAY AND FOREVER."

**KETHER**

"BRAHMA" ATMA SELF

**JOHN 4:8** "GOD IS LOVE."  
**JOHN 15:5** "I AM THE VINE, YOU ARE THE BRANCHES!"



**THE DESCENT OF MANIFESTATION**  
 ALL CREATION BEGINS AS AN EMANATION FROM THE DIVINE MIND. FROM SUBTLE TO DENSE, THE TREE UNFOLDS AND SPIRIT DESCENDS INTO MATTER.

**REV 21:6** "IT IS DONE. I AM THE ALPHA AND THE OMEGA." A → Z

**PSALM 23:4** "YOUR ROD AND YOUR STAFF THEY COMFORT ME."  
 "GOD IS MAN AWAKE" - Angels -



THE INFINITE CYCLE OF CONSCIOUSNESS IS THE OURBOROS, SNAKE EATING HIS TAIL, CONSTANT GENERATION, OPERATION, AND DESTRUCTION.  
 G.O.D. - DBBD



THE ZIGZAG OF CREATION IS CALLED THE LIGHTNING FLASH OF CREATION, OR THE FLAMING SWORD OF SOPHIA.

HIGH FREQ MATTER = LIGHT  
 LOW FREQ LIGHT = MATTER

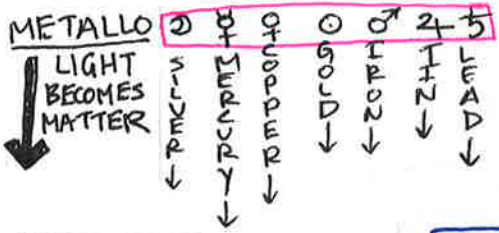

THE RETURN OF ENERGY FROM DENSE MATTER BACK THROUGH THE VARIOUS STAGES, SEPHIROTH AND WORLDS OF CREATION, IS KNOWN AS THE 'PATH OF THE SERPENT' BECAUSE OF ITS REVERSE OF COMPLIMENTARY ZIG ZAG NATURE BACK UP THE DIAGRAM CALLED THE TREE OF LIFE.

GENESIS 1:1 "IN THE BEGINNING OF CREATION AND THE ELOHIM CREATED THE HEAVENS AND THE EARTH."

**LUKE 10:18** JESUS SAYS "I SAW SATAN FALL LIKE LIGHTNING FROM HEAVEN."

**2 CORINTHIANS 11:14** "AND NO MARVEL; FOR SATAN HIMSELF IS TRANSFORMED INTO AN ANGEL OF LIGHT."

**JOHN 14:10** "BELIEVEST THOU NOT THAT I AM IN THE FATHER AND THE FATHER IN ME? THE WORDS THAT I SPEAK UNTO YOU YOU SPEAK NOT OF MYSELF: BUT THE FATHER THAT DWELLETH IN ME, HE DOETH THE WORKS."

**GENESIS 1:28** "COME LET US MAKE MAN IN OUR IMAGE AND IN OUR LIKELINESS."

- ZOHAR** "THE SOURCE OF ALL CREATION"
9. DIO/GOD • DIVINE • 3rd Heaven - Minds of Celestial Angels
  8. Seraphim • ABYSS... • 2nd Heaven - Minds of Spiritual Angels
  7. Cherubim • MENTAL • 1st Heaven - Minds of Natural Angels
  5. Dominions • ASTRAL • Spiritual Realm - Minds of Earthlings
  4. Powers
  3. Principalities
  2. Archangels
  1. Angels • MATERIAL • Hell Realm - Minds of Devils

**ROMANS 16:20** "THE GOD OF PEACE WILL SOON CRUSH SATAN UNDER YOUR FEET."

**MATTHEW 6:19** "DO NOT LAY UP FOR YOURSELVES TREASURES ON EARTH WHERE MOTH AND RUST DESTROY, AND WHERE THIEVES BREAK IN AND STEAL."

WHAT HAPPENS ABOVE DICTATES WHAT HAPPENS BELOW.  
**JOHN 5:19** "THE SON CAN DO NOTHING OF HIMSELF UNLESS IT IS SOMETHING HE SEES THE FATHER DOING."

**JOHN 10:30** "I AND THE FATHER ARE ONE."



∞  
 — ITS ALL ABOUT BALANCE —  
 AND ELEVATING CONSCIOUSNESS

**JOHN 4:8** "HE WHO DOES NOT KNOW LOVE, HAS NOT COME TO KNOW GOD BECAUSE GOD IS LOVE."

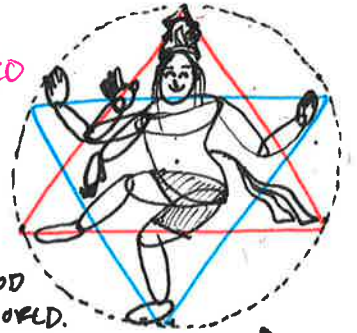

SHIVA  
 HEX-SIX-SEX

NUWA & FUXI



BROTHER & SISTER  
 WHO SURVIVE THE FLOOD  
 AND REPLENISH THE WORLD.

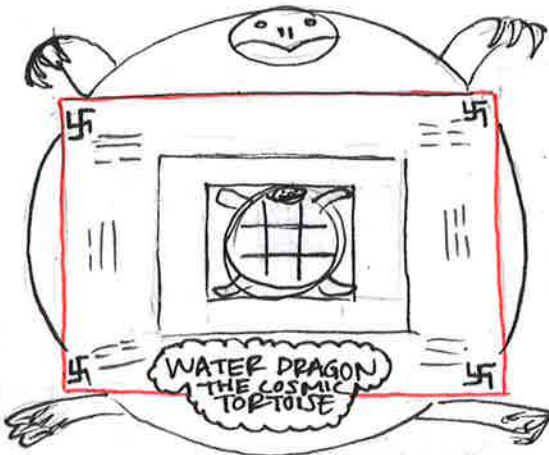

HERMES-HERMIT  
 — WE FIND LIGHT IN DARKEST —

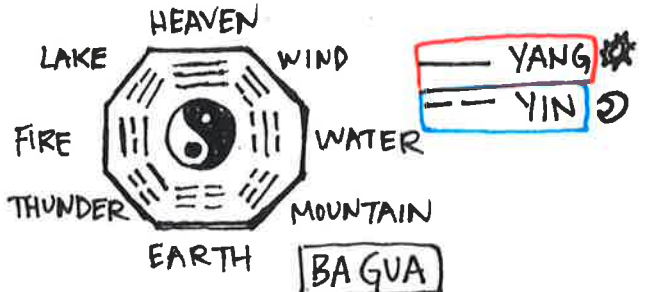

BAGUA

— THE EIGHT DIAGRAMS —

**PSALMS 52:3** "YOU LOVE EVIL RATHER THAN GOOD, FALSEHOOD RATHER THAN SPEAKING THE TRUTH."



REBIS  
 "HERMAPHRODITUS"

REBIS = RES-BINA & DUAL-MATTER

**GALATIANS 4:16**

"HAVE I BECOME YOUR ENEMY BY TELLING YOU THE TRUTH."

**GENESIS 1:29** "GOD SAID BEHOLD I HAVE GIVEN YOU EVERY HERB THAT YIELDS SEED WHICH IS ON THE FACE OF THE EARTH, AND EVERY TREE WHOSE FRUIT YIELDS SEED. TO YOU SHALL BE FOR FOOD. ALSO TO EVERY BEAST OF THE EARTH, TO EVERY BIRD OF THE AIR AND EVERY CREATURE THAT CRAWLS UPON THE EARTH, IN WHICH THERE IS LIFE, I HAVE GIVEN EVERY GREEN HERB FOR FOOD AND IT WAS SO."

**MATTHEW 7:16**

"BEWARE THE FALSE PROPHETS YOU WILL KNOW THEM BY THEIR FRUITS."

HEBREWS 13:5 "KEEP YOUR LIFE FREE FROM LOVE OF MONEY AND BE CONTENT."



ST MICHAEL IS THE SYMBOL OF A BALANCED HUMAN, THE SUN @ THE CENTER IS THE VINE, THE OTHER PLANETS ARE THE BRANCHES!!

CHRONICLES 16:12  
 "NET IN HIS DISH HE SOUGHT NOT TO THE LORD, BUT TO THE PHYSICIANS."

**TITUS 2:13** "AND WE WAIT FOR THE BLESSED HOPE AND GLORY OF THE APPEARING OF OUR GREAT GOD AND SAVIOR JESUS CHRIST."



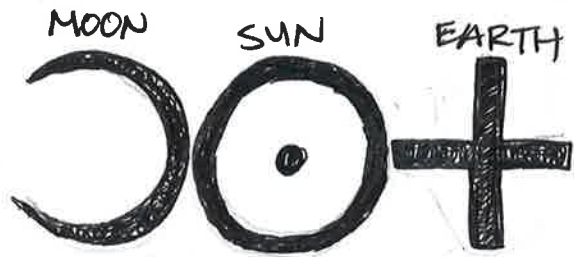

THE 3 PRIMAL SYMBOLS OF CONSCIOUSNESS

THE 7 TRADITIONAL METALS OF THE ALCHEMISTS AND THEIR TRANSMUTATION.

WE CAN EXAMINE HOW THE TRANSFORMATION OF OUR CONSCIOUSNESS IS DEPICTED THROUGH THE TRANSFORMATION OF THESE METALS.

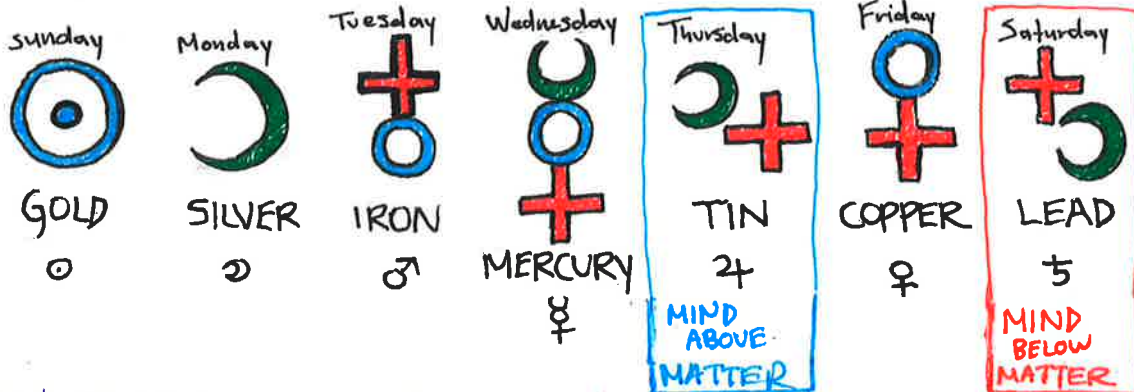

WHEN THE CROSS DOMINATES, THE SOUL IS BURIED BY THE EARTH.



THE SYMBOL OF MERCURY REVEALS 3 LEVELS OF CONSCIOUSNESS, THE FIXED IN MATTER AS THE SALT, ANIMALISTIC NATURES, AND EARTHLY ELEMENT, THE CRESCENT IS THE REFLECTION OF THE SELF CONSCIOUSNESS, AND THE CIRCLE IS THE RADIATING, SPIRITUAL DIVINE CENTRE... THE LIGHT.

MERCURY IS THE ALLEGORICAL SYMBOL OF CONSCIOUSNESS IN ITS RAW STATE ITS THE FACE OF THE STILL WATERS OF THE GREAT SEA OVER WHICH THE SPIRIT FLEW, THE 'PRIMA MATERIA'

IT IS SOLID AND LIQUID @ THE SAME TIME, THEREFORE MERCURY TRANSCENDS LIFE AND DEATH.

THE CIRCLE IS THE SYMBOL OF WHOLENESS, THE SOLAR PRINCIPLE, THE RADIATING FORCE. THIS SYMBOLIZES MAN @ HIS HIGHEST ORDER OF BEING. IT ALSO REPRESENTS THE SPIRITUAL LIFE AND ATTUNEMENT WITH THAT WHICH IS UNIVERSAL.

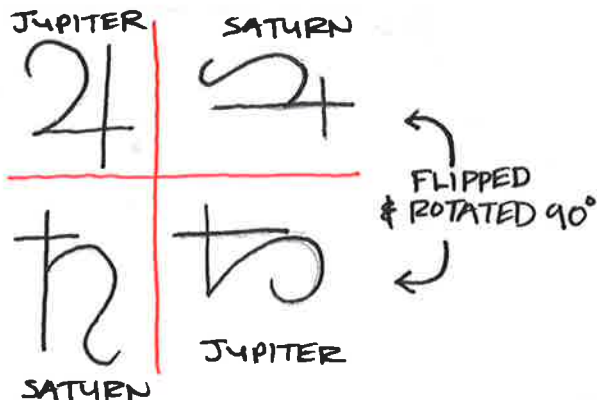

+

SALT REPRESENTS THE CONTRACTING FORCE. (CONDENSATION) (CRYSTALLIZATION)

♀ MERCURY IS THE OMNI-PRESENT SPIRIT OF LIFE. IT TRANSCENDS LIFE AND DEATH (LIQUID & SOLID)

♁ SULFUR IS USED TO DENOTE THE EXPANSIVE FORCE (EVAPORATION) (DISSOLUTION)



DIAMETER

SUN = 864K MILES  
 EARTH = 7,920 MILES  
 MOON = 2,160 MILES  
 MAN = 72 INCHES

SUN = 8.64  
 EARTH = 7.92  
 MOON = 2.16 +  
 MAN = 7.2  
 -----  
 25.92

$24 \times 60 \times 60$   
 86,400 SECONDS IN A DAY  
 $\div 33333 = 25,920$

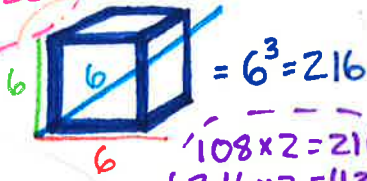

$108 \times 2 = 216$   
 $216 \times 2 = 432$   
 $432 \times 2 = 864$   
 $864 \times 3 = 2592$

- 1.68
- 3.375
- 6.75
- 13.5
- 27
- 54
- 108
- 216
- 432
- $864 \times 3 =$
- 2,592

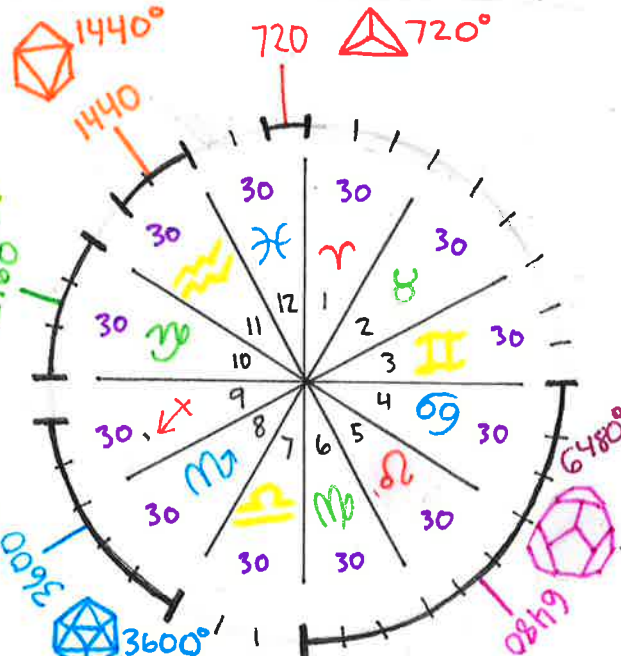
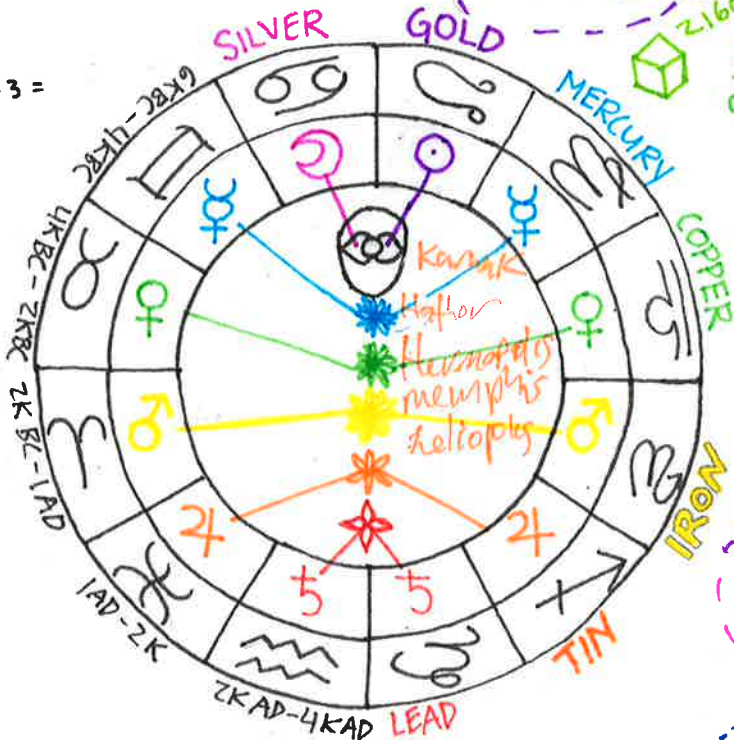

$\frac{.636}{1.2722}$   
 $\frac{1.2722}{1.618}$   
 $\frac{4 \div \pi}{1.2722} = 3.144$   
 $\frac{4 \div 3.144}{1.2722} = 1.2722$

$1.618 = \frac{1 + \sqrt{5}}{2}$   
 $\phi = \frac{1 + 2.236}{2}$

$\frac{2.236}{5}$   
 $\frac{1.61}{2.592}$

THE PRECESSION OF THE ECLIPTIC IS 72 YEARS PER DEGREE.  $72 \times 360^\circ = 25,920$

1 PLATONIC MONTH OR AGE IS 2160. 72 YEARS TIMES 30 DEGREES = 2,160

THE AVERAGE HUMAN ADULT HAS A HEARTBEAT 70 BPM  $70 \div 1.618 = 43.2$

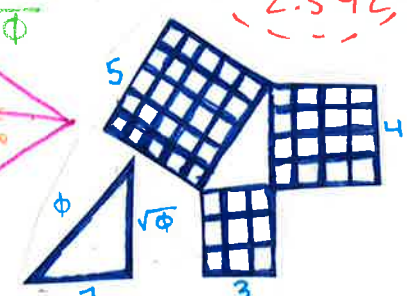
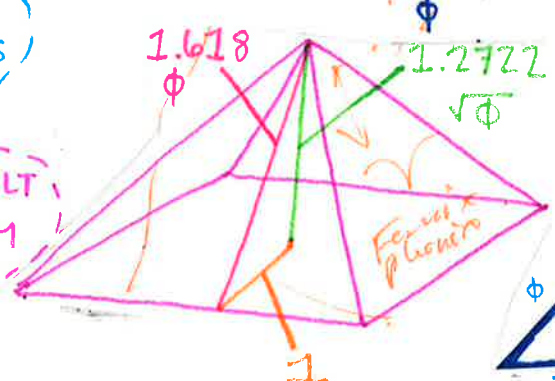

$\frac{432}{432} = \text{"Speed of Light"}$   
 $186,282$  MPS

$\frac{25920}{671,864,400} = \text{"Speed of Light"}$   
 671 Million MPH



positive and negative  
"RED SHIFT / BLUE SHIFT" - Walter Russel!  
WALTER RUSSEL - "IN THE WAVE LIES THE SECRET OF CREATION."  
"TO KNOW THE MECHANICS OF THE WAVE IS TO KNOW THE ENTIRE SECRET OF NATURE."

NIKOLA TESLA - "THINK IN TERMS OF ENERGY, FREQUENCY AND VIBRATION TO FIND THE SECRETS TO THE UNIVERSE."  
"IF YOU KNEW THE MAGNIFICENCE OF 3, 6, 9 YOU WOULD HAVE THE KEY TO THE UNIVERSE." TESLA STUDIED ROGER BOSCHVICH "THE THEORY OF NATURAL PHILOSOPHY" [1763]

Leonardo Davinci: "If you find from your own experience that something is a fact and it contradicts what some authority has written down, then you must abandon the authority and base your reasoning on your own findings."

NIKOLA TESLA: "One must be sane to think clearly but one can think deeply, and be quite insane."  
"Light cannot be anything else but a longitudinal disturbance in the Ether involving alternate compressions and rarefactions. In other words light can be nothing else than a sound wave in the Ether."

"The Moon does rotate not on its own but about an axis at the center of the Earth, the True and only one."

J.J. Thompson: "An Electron is 1 unit of DiElectric Discharge." <sup>THE CONCEPT OF 1856-1940</sup>

Michael Faraday: "Magnetism is the DiElectric Field." <sup>1791-1867</sup>

Eric Dollard: "You cant understand the ELECTRIC Field Theory without knowing what counterspace is."

Walter Russel The Secret of Light, Atomic Suicide The Universal One.

Charles Proteus Steinmetz Elementary Lectures on Electric Discharges, waves and Impulses [1911]

Ptolemy Geocentric Stationary Earth (Primum Mobile)

Michaelson Morely Experiment [1887]

1. There is only a  $15^\circ$  per hour,  $360^\circ$  daily rotation over a 24 hour period. (No other Motion Detected)
2. We are not revolving at 30 KMPS or 66,600 MPH around the Sun, Nor are we rotating.
3. The Stars Turn Counter Clockwise above our heads, circling the north pole, and rising from the East and setting to the West.

The Double Slit Experiment

[1801] 1. Proof that Light Particles such as photons don't exist, Light acts as a wave as it splits and recombines like water around a log sticking up in a river.

LIGHT BECOMES MATTER = SPATIUMATTER  
THE INSUPERABLE WAVELOS

~ IMPLICIT WHOLENESS to the entire Universe. ~  
KEN WHEELER - "HYDROGEN, THE MOST FUNDAMENTAL PARTICLE IN THE UNIVERSE, IS ULTRA HIGH ENERGY LIGHT."



THE MIND IS AN INTELLIGENT SOLUTION.  
ALL PHYSICALITY IS AN EMERGENT PROPERTY  
OF THE PHYSICAL CONSTRAINTS OF THE SYSTEM.

ITS EVERYWHERE, YET TAKES  
UP NO SPACE... USING FRACTAL  
GEOMETRY / GENETICS.

HOW DID OUR NEO CORTEX, NEURONS & BLOOD  
VESSELS IN OUR CIRCULATORY SYSTEM GET  
WIRED UP? BIFURCATION & ARBORIZATION,  
LIKE SYSTEMS OF A PLANT. PROFESSOR  
ROBERT SAPOLSKY - 2010 STANFORD, HAS  
LECTURES TITLED "CHAOS & REDUCTIONISM";  
ALSO "EMERGENCE & COMPLEXITY".

ITS A MATHEMATICAL  
SOLUTION USING A FRACTAL  
SYSTEM TO SOLVE THE  
PACKING PROBLEM.

**ANANKÉ** = NECESSITATIVELY  
MEANING  
NO OTHER  
WAY.....

A SCALE FREE PRINCIPLE IS NECESSARY.  
- A FRACTAL INSTRUCTION OR RULE: GROW  
UNTIL IT IS 5 TIMES LONGER THAN IT  
IS WIDE, WHICH WOULD BE THE DIAMETER  
OR CROSS SECTION OF THE TUBE, THEN  
SPLIT AT THAT CERTAIN POINT. THE  
DISTANCES BETWEEN THE SPLITTING  
GETS SHORTER; WHEN DEALING WITH  
BIFURCATION.

ROB. SAPOLSKY -  
"THERE ARE NOT  
ENOUGH GENES IN THE  
GENOME TO MAKE UP  
FOR THE NEURONAL  
COMPLEXITY IN OUR  
BRAINS FROM SINGLE  
CELL NEURONS TO  
MULTICELLULAR BODIES  
LIKE THE CIRCULATORY  
SYSTEM. - WHICH IS ONLY  
5% OF THE BODIES MASS.



FRACTAL

"FRACTALS WE ARE ALL  
OF INFINITE CONSCIOUSNESS"

WE ARE THE SALT OF THE EARTH...  
THAT IS OUR BODIES... WHICH IS DUST  
THAT WILL RETURN TO THE EARTH... OUR  
SOULS HOWEVER ARE NOT MADE OF SALT  
OR DUST, IT RETURNS TO THE AETHER.  
WE ARE SPIRITS IN A HUMAN VESSEL.

MAN IS GOD ASLEEP, THE HUMAN BODY  
ITSELF IS NOT GOD, IT IS JUST THE AVATAR  
GOD USES WHEN DREAMING UP THIS WORLD  
THAT WE CALL OUR CURRENT REALITY.

GOD IS YOU, AND YOU ARE THE SOUL,  
NOT THE BODY, WHICH IS JUST A  
VESSEL FOR GOD... WHICH IS YOU.

YOUR SOUL IS PURE ETERNAL LIMITLESS  
UNCONDITIONAL ENERGY... THEREFORE  
YOU ARE GOD BECAUSE YOU ARE AN  
ETERNAL SOURCE OF ENERGY. YOU ARE  
YOUR SOUL, LIFE ITSELF.. GODS INTELLIGENCE  
IS WITHIN, THATS WHY IT SAYS GOD IS  
WITHIN YOU IN THE BIBLE; GOD IS MAN  
AWAKE.



-THIS PHYSICAL TEMPORARY FORM IS NOT OUR PRIMORDIAL STATE.  
WE ARE ALL JUST SPIRITS TRAPPED IN A HUMAN BODY, ALL SPIRITS  
ARE ONE SOUL ENERGY, SEPERATED INTO DIFFERENT BODIES....

ALL IS ONE - ONE IS ALL. ENERGY -



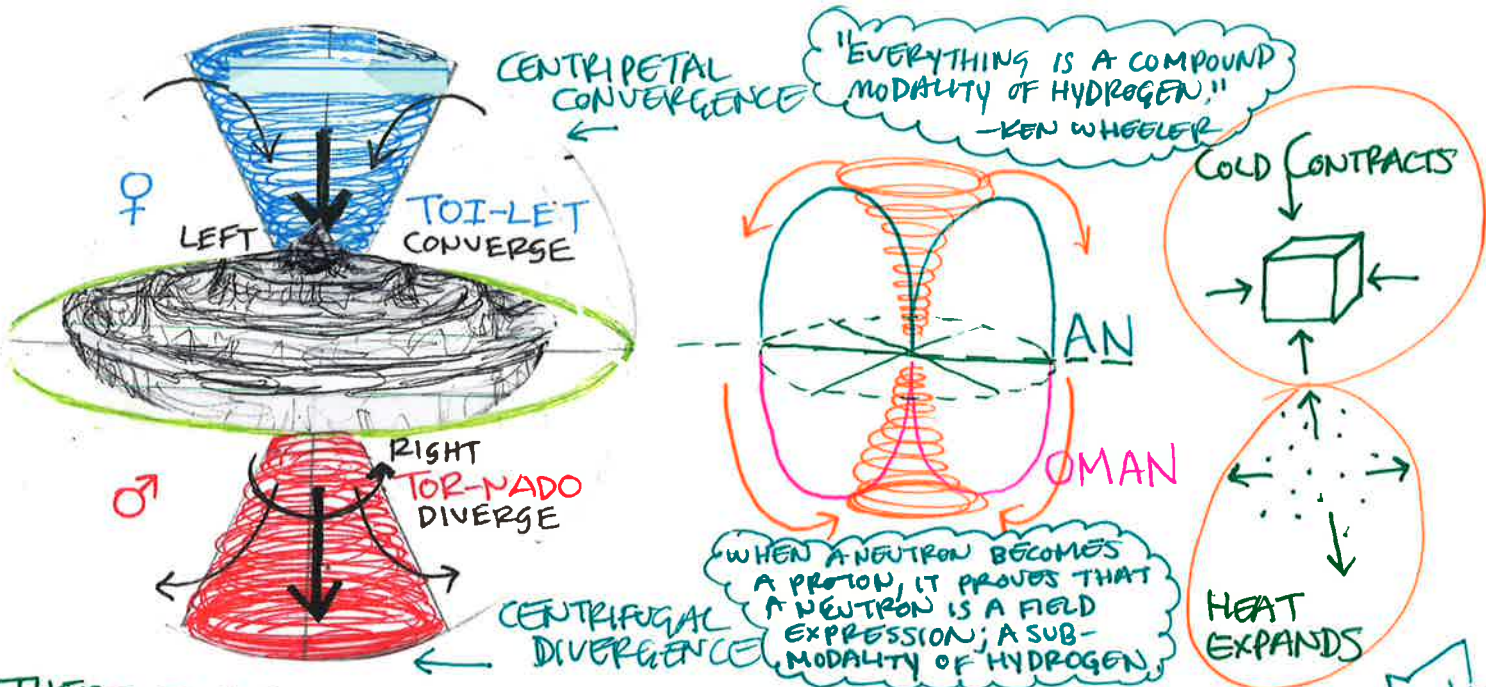

THERE IS A PERPETUAL VORTEX AT THE CENTER OF THE WORLD @ THE NORTH POLE. NIKOLA TESLA WANTED THIS FACT TO BE KNOWN BY ALL, BUT OTHERS BEGGED TO DIFFER. THE FREE ENERGY TESLA MENTIONED IS UNDOUBTEDLY THE TRUE REALIZATION THAT INFINITE SOURCE POWER ENERGY EXISTS, NOT ONLY IN OUR UNIVERSE BUT ITS RIGHT WITHIN OUR REACH, @ THE CENTER OF ALL OUR CONTINENTS AND OUR OCEANS. THOUGH OUR OCEANS ARE SATURATED WITH SALT, THERE IS A PERPETUAL FOUNTAIN OF FRESH WATER, BECAUSE THE ENTIRE CONCEPT OF THE UNIVERSE IS TO ETERNALLY RECYCLE MATTER, TRANSFORMING THE INFINITE ENERGIES OF SOURCE, WHICH CAN NEVER BE CREATED NOR DESTROYED.

THE HUMAN BODY IS PHYSICAL AND THE MIND IS NON-PHYSICAL. THE BODY IS OF THE EARTH, AND THE MIND IS OF THE AETHER. THE CONCEPT OF PHYSICS AND META PHYSICS IS NO DIFFERENT THAN HEADS AND TAILS OF A COIN, AS KEN WHEELER CLARIFIES.

COUNTERSPACE & SPACE THE TORUS AND THE HYPERBOLA, TOGETHER THESE ARE THE CONJUGATE FIELDS OF THE UNIVERSE, EACH BEING THE INVERSE GEOMETRY OF EACH OTHER.

MAGNETISM IS THE TOKOIDAL AETHER RAREFACTION (FUNDAMENTAL FORCE) CENTRIFUGAL DIVERGENCE "RIGHT TURNING" FORCE & MOTION, CREATING VOLUME. -ITS THE DIELECTRIC FIELD, WHEN IT LOSES INERTIA (THE LOSS OF ENERGY) OR (DIELECTRIC TORSION) -ITS THE 3 DIMENSIONAL "S CURVE" OF A FORCE VECTOR WHICH EXTRAPOLATES INTO AND AS THE TORUS, (THE VOLUMINOUS MAGNETIC FIELD).

THE DIELECTRIC HYPERBOLOIDAL FIELD INCREASES INERTIA & ACCELERATES TO THE CENTER OF THE MAGNETIC FIELD (TOWARDS COUNTERSPACE) THE LOWEST PRESSURE ZONE.

ELECTRICITY IS THE COMPOUND OF DIELECTRICITY & MAGNETISM COLLECTIVELY, -ITS NOT AN AUTONOMOUS FIELD, LIKE MAGNETISM WHICH CAN STAND ON IT OWN, AND MAGNETISM IS THE FULL EXTRAPOLATION OF CENTRIPETAL CONVERGENCE OF THE DIELECTRIC FIELD. LIGHT IS THE LOWEST EXTRAPOLATION, LOW ENERGY, CYCLIC CIRCUITS. COMPOUND

THE PARADOXICAL CONJUGATE FIELDS  
 SPACE & MATTER  
 ~ ALL PHYSICITY IS SUSTAINED BY MOTION ~



~ WE ARE ALL THE CHOSEN ONES ~ MY BODY "IS REAL LIGHT"

1000 x 144 =  
**144,000**

**ROMANS 8:11** "THE VERY SAME SPIRIT THAT RAISED JESUS FROM THE DEAD IS ALIVE IN YOU.!!"

**REV. 7:3** "TILL WE HAVE SEALED THE SERVANTS OF OUR GOD IN THEIR FOREHEADS, AND I HEARD THE NUMBER OF THEM WHICH WERE SEALED, AND THERE WERE SEALED **144,000** OF ALL THE TRIBES OF THE CHILDREN OF ISRAEL."

**REV. 14:1** "THEN I LOOKED AND BEHOLD A LAMB STANDING ON MOUNT ZION AND WITH HIM **144,000** WHO HAD HIS NAME AND THEIR FATHERS NAME WRITTEN ON THEIR FOREHEADS."

**REV. 21:10** "AND HE CARRIED ME AWAY IN THE SPIRIT TO A GREAT HIGH MOUNTAIN AND SHOWED ME THE CITY JERUSALEM, COMING OUT OF HEAVEN FROM GOD. ITS RADIANCE LIKE A MOST FARE JEWEL."

**REV. 21:14** "AND THE WALL OF THE CITY HAD 12 FOUNDATIONS AND IN THEM THE NAMES OF THE 12 APOSTLES OF THE LAMB."

**REV. 21:17** "AND HE MEASURED THE WALL THEREOF **144 CUBITS**, ACCORDING TO THE MEASURE OF MAN THAT IS, OF THE ANGEL."

**2 CORINTHIANS 12:17** "I KNOW A MAN IN CHRIST WHO 14 YEARS AGO WHETHER IN THE BODY OR OUT OF THE BODY I DO NOT KNOW, GOD KNOWS. SUCH A ONE WAS CAUGHT UP TO THE 3RD HEAVEN."

**KINGS 6:8** "THE ENTRANCE TO THE LOWEST FLOOR WAS ON THE SOUTH SIDE OF THE TEMPLE, A STAIRWAY LED UP TO THE MIDDLE LEVEL, AND FROM THERE THE 3RD."

**ECCLIESASTES 12:7** "THEN SHALL THE DUST RETURN TO EARTH AS IT WAS, AND THE SPIRIT SHALL RETURN TO GOD WHO GAVE IT."

**2 CORINTHIANS 4:18** "SO WE FIX OUR EYES NOT ON WHAT IS SEEN BUT WHAT IS UNSEEN, FOR WHAT IS SEEN IS TEMPORAL BUT WHAT IS UNSEEN IS ETERNAL."

**CORINTHIANS 3:16** "DO YOU NOT KNOW THAT YOU ARE THE TEMPLE OF GOD, AND THAT THE SPIRIT OF GOD LIVES IN YOU?"

**ACTS 7:48** "THE MOST HIGH DWELLS NOT IN TEMPLES MADE WITH 2 HANDS."

**ROMANS 1:20** "FROM THE CREATION OF THE WORLD GODS INVISIBLE QUALITIES, HIS ETERNAL POWER AND DIVINE NATURE HAS CLEARLY BEEN OBSERVED."

**KINGS 8:1** "THE MOST HOLY HOUSED THE ARK OF THE COVENANT WHICH SAT BETWEEN 2 MASSIVE CHERUBS." - 2 CEREBRAL HEMISPHERES.

**MARK 16:19** "JESUS WAS TAKEN UP TO HEAVEN AND HE SAT AT THE RIGHT HAND OF GOD." - RIGHT HEMISPHERE OF THE BRAIN!

**PSALM 82:6**

"I HAVE SAID YOU ARE GODS AND WE ARE ALL FRACTALS OF INFINITE CONSCIOUSNESS - DBBD"

3rd



INNER DOME

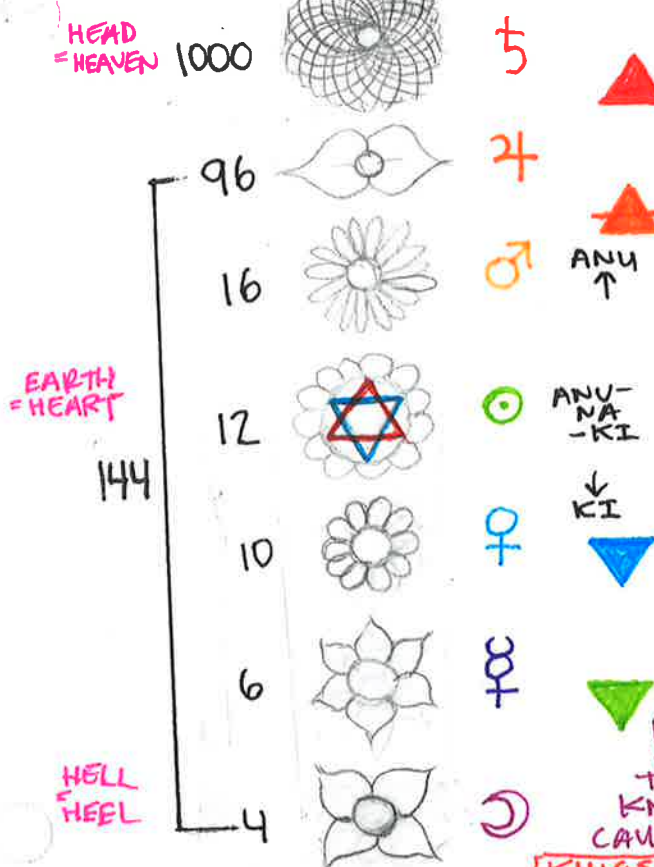

**GENESIS 6:4** "THERE WERE THE NEPHILIM ON EARTH IN THOSE DAYS, AND ALSO AFTER THAT, WHEN THE SONS OF GOD ~~WENT DOWN~~ CAME UNTO THE DAUGHTERS OF MEN ~~AND THEY BECAME~~ CHILDREN TO THEM."

**2 CORINTHIANS 5:1** "NOW WE KNOW THAT IF THE EARTHLY TENT WE LIVE IN IS DESTROYED WE HAVE A BUILDING FROM GOD, AN ETERNAL HOUSE IN HEAVEN NOT BUILT BY HUMAN HANDS, BECAUSE WE ARE CLOTHED, WE CANNOT BE FOUND NAKED."

**LUKE 17:21** "THE KINGDOM OF GOD DOES NOT COME WITH OBSERVATION; NEITHER SHALL THEY SAY LOOK HERE NOR LOOK THERE FOR BEHOLD THE KINGDOM OF GOD IS ~~WITH YOU~~ IN YOUR MIDST." MID SECTION OF THE BRAIN!



**THIS WORLD IS NOT OUR HOME**

**Colossians 3:2** "SET YOUR MIND ON THINGS THAT ARE ABOVE NOT ON THINGS THAT ARE ON EARTH!"

**2 Corinthians 5:8** "YES WE ARE OF GOOD COURAGE AND WE WOULD RATHER BE AWAY FROM THE BODY AND @ HOME WITH THE LORD."

**2 Corinthians 5:2** "Far in this tent we groan longing to put on our Heavenly Dwelling."

**John 8:23** "He said to them you are from below I am from above, you are of this world, I am not of this world."

**1 Peter 2:11** "Dear friends I urge you as foreigners and exiles to abstain from fleshly desires which wage war against your soul. Live such good lives amongst the evil doers."

**Romans 12:2** Do not be conformed to this world, but be transformed by the renewal of your mind, that by testing, you may discern what is the will of God what is good acceptable and perfect.

**2 Corinthians 10:3** "For though we walk in flesh, we are not waging war according to the flesh."

**John 5:19** "We know that we are from God, and the whole world lies in the power of the evil one."

THE GREEN LION BIRTHED FROM ROYAL WATER. I AM HE WHO WAS THE GREEN AND GOLD LION WITHOUT CARES, WITHIN ME LIES ALL THE MYSTERIES OF THE PHILOSOPHERS

V.I.T.R.I.O.L. = "Visit The Interior Parts of the Earth by Rectification Thou Shalt Find the Hidden Stone."

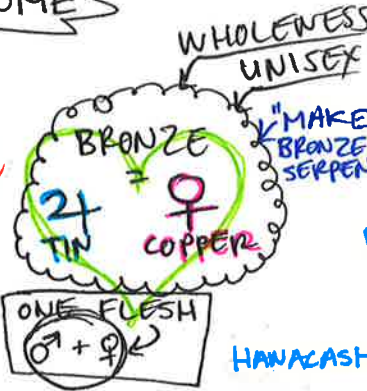

SERAPHIM = FIERY SERPENTS WHICH ARE THE CLOSEST TO GOD.



NUMBERS 21:6  
 מַכַּחֲשִׁים  
 Machachashim  
 מַכַּחֲשִׁים  
 Machachashim  
 HANAKASHIM HASERAPHIM

NUMBERS 21:9  
 נָחָשׁ  
 NAGASH  
 Shin - Koph - Nun  
 NACASH = SNAKE

נֶחֱשֶׁת  
 NACHASHET  
 Tav - Shin - Vav - Koph - Nun  
 NECOSHET = COPPER

**NEPHI 17:41** AND HE DID STRAITEN THEM IN THE WILDERNESS WITH HIS ROD; FOR THEY HARDENED THEIR HEARTS, EVEN AS YE HAVE; AND THE LORD STRAITENED THEM BECAUSE OF THEIR INIQUITY. HE SENT FIERY FLYING SERPENTS AMONG THEM; AFTER THEY WERE BITTEN HE PREPARED A WAY TO LOOK; AND BECAUSE OF THE SIMPLENESS OF IT, THERE WERE MANY WHO PERISHED

**EZEKIEL 1:20** WHEREVER THE SPIRIT WAS ABOUT TO GO THEY WOULD GO IN THAT DIRECTION, AND THE WHEELS WOULD RISE ALONG BESIDE THEM, FOR THE SPIRIT OF THE LIVING BEINGS WAS IN THE WHEELS.

**EZEKIEL 1:16** "AND THE APPEARANCE AND THEIR WORK WAS IT, WERE A WHEEL IN THE MIDDLE OF A WHEEL."

- V. - Visitae
- I. - Interiora
- T. - Terrae
- R. - Rectificando
- I. - Invenies
- O. - Occultum
- L. - Lapidem

BLOOD OF THE SUN  
 TEARS OF THE MOON



**HEBREWS 13:14** FOR HERE WE DO NOT HAVE A LASTING CITY BUT WE ARE SEEKING THE CITY WHICH IS TO COME.

MEANING: WHEN YOU COME TO THE GREEN HEART CHAKRA, YOU ARE ENERGIZED WITH LOVE. EARTH = HEART.

**EPHESIANS 6:12** FOR OUR STRUGGLE IS NOT AGAINST FLESH AND BLOOD BUT AGAINST THE RULERS AGAINST THE AUTHORITIES, AGAINST THE POWERS OF THIS DARK WORLD, AND AGAINST THE SPIRITUAL FORCES OF EVIL IN THE HEAVENLY REALMS.



SOLOMONS TEMPLE

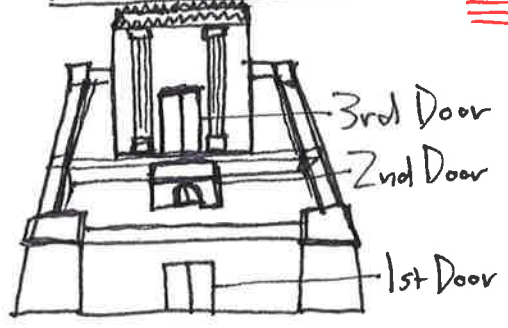

THE HIGH PRIEST.

THE TABERNACLE } SANCTUARY  
TENT OF MEETING

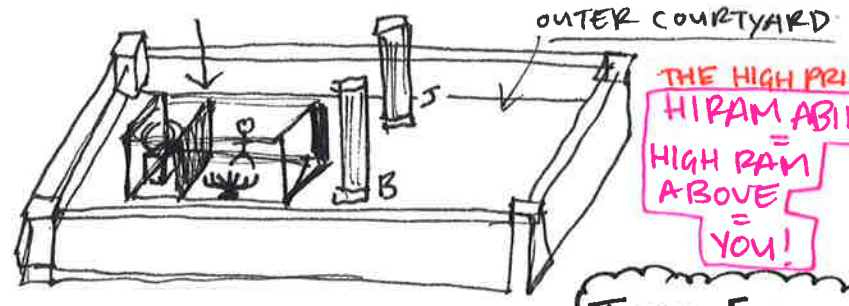

THE HIGH PRIEST.  
HIRAM ABIFF  
HIGH RAM  
ABOVE  
= YOU!  
← SELF.  
↑ YOU HIGHER

THE TEMPLE OF THE SOUL OF MAN... THE VEIL IS LIFTED, WHEN WE BURN THE CANNABIS AT THE ALTAR OF INCENSE; WHERE WE ALTER OUR MIND TO UNLOCK OUR INNER-SENSE.

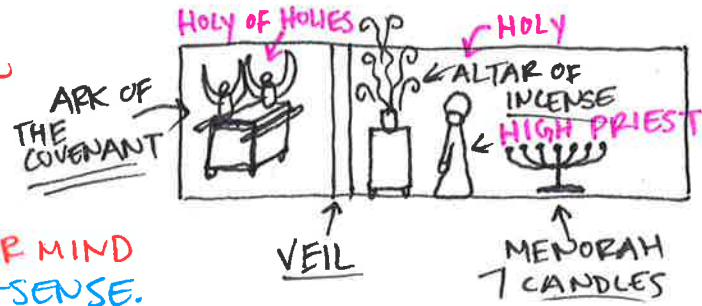

JERV-SALEM  
HERV-SELENE  
SOL-O-MOON

GOD SPECIFICALLY ASKS FOR (KANEH BOSOM) TO BE OFFERED TO HIM AS AN INCENT, 5 TIMES IN THE BIBLE.

WE HAVE AN ENDO CANNABINOID SYSTEM, WHICH REGULATES ALL SYSTEMS OF THE BODY. INGEST CANNABIS TO REGULATE THE HORMONE FUNCTIONING SYSTEM, AND TO CREATE HOMEOSTASIS WITHIN ALL FUNCTIONS IN THE SYSTEMS.

THE USE OF CANNABIS - IS A MASTER HEALING TOOL; IT TAKES ONE AWAY & ALLOWS ONE TO FIND THE SELF VERY EASILY, AETHERICAL ENERGIES ARE PULLED IN, AND STREAMS STRAIGHT FROM THE AETHER.

THE SKULL IS THE MOST HOLY; ITS THE BONE WITH THE MOST HOLES IN IT. THE ARK OF THE COVENANT IS THE CENTER PART OF THE BRAIN BETWEEN THE 2 HEMISPHERES OF THE CEREBRUM WHICH THE BIBLE REFERS TO AS CHERUBIM, THEY PROTECT WHATS HOLY. ON TOP OF THE ARK IS CALLED THE MERCY SEAT, WHILE THE PINEAL GLAND IS CALLED THE SEAT OF THE SOUL; IN THE ARK IS MOSES' STAFF WHICH REPRESENTS THE SPINE & ALSO THE 2 TABLETS AS WELL AS THE HOLY GRAIL & THE MANA FROM HEAVEN, THE HOLY OIL, WHICH IS THE CEREBRAL SPINAL FLUID.

REV 8:1 WHEN HE OPENED THE 7TH SEAL, THERE WAS SILENCE IN HEAVEN FOR ABOUT A HALF HOUR, AND I SAW THE 7 ANGELS WHO STAND BEFORE GOD. AND TO THEM WERE GIVEN 7 TRUMPETS.

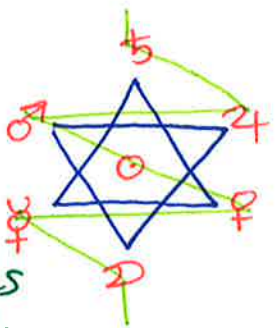

IN MICHAELANGELOS PAINTING "THE DREAM" @ THE METROPOLITAN MUSEUM OF ART, THERE IS AN ANGEL BLOWING A TRUMPET INTO THE 3RD EYE OF THE NUDE YOUTH WHO IS HOLDING A SPHERE WHICH MEANS SPIRIT.



The TEMPLE of the SOUL of MAN.

SOL & MOON TEMPLE  
IS YOU!

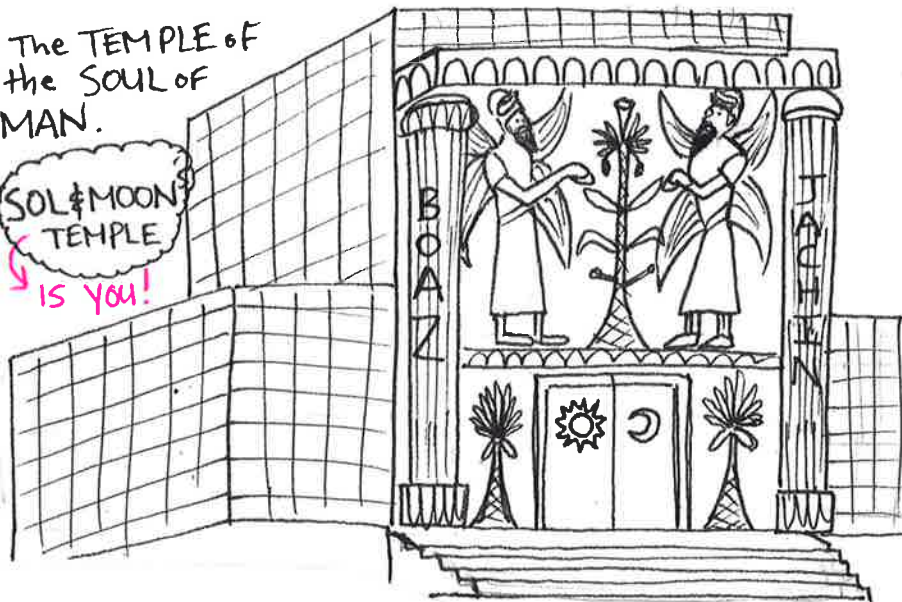

"A NEW HEAVEN & A NEW EARTH."

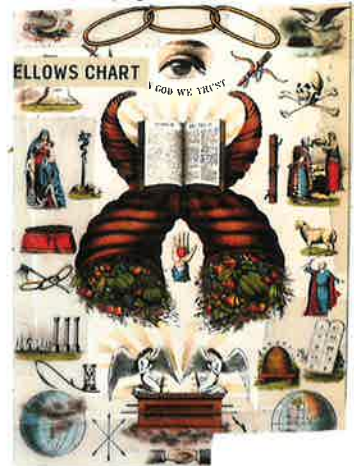

"A NEW JERUSALEM & THE BRIDE OF THE LAMB."

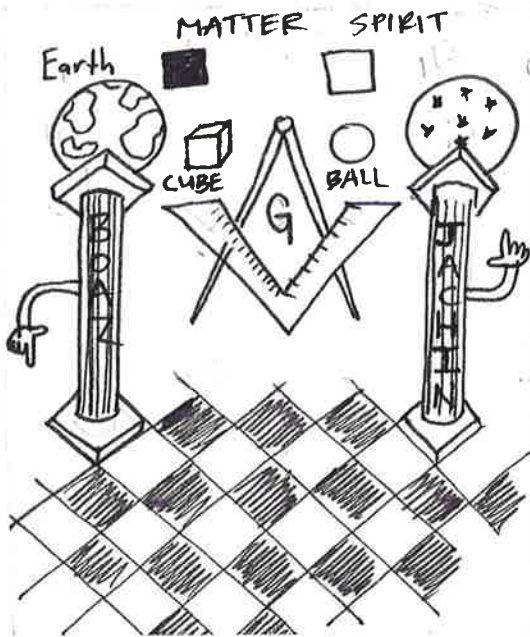

LUKE 17:21

"THE KINGDOM OF GOD DOES NOT COME WITH OBSERVATION; NEITHER WILL THEY SAY LOOK HERE OR LOOK THERE, FOR BEHOLD, THE KINGDOM OF GOD IS IN YOUR MIDST."

MIDST = MIDDLE

REV. 21 "THE CITY SHALL NOT NEED A SUN OR A MOON, FOR THE LAMB SHALL BE ITS LAMP."

OPTIC THALAMUS = PTAHS LAMP

REV 21:10 AND HE CARRIED ME AWAY IN THE SPIRIT TO A GREAT HIGH MOUNTAIN AND SHOWED ME THE HOLY CITY JERUSALEM COMING OUT OF HEAVEN FROM GOD. HAVING THE GLORY OF GOD ITS RADIANCE LIKE A MOST PURE JEWEL, LIKE A JASPER, CLEAR AS CRYSTAL. IT HAD A GREAT WALL W/ 12 GATES, 12 ANGELS & THE NAME OF THE 12 TRIBES OF ISRAEL WERE INSCRIBED ON THE GATES. AND THE WALL OF THE CITY HAD 12 FOUNDATIONS AND IN THEM THE NAMES OF THE 12 APOSTLES OF THE LAMB. AND HE MEASURED THE WALL THEREOF 144 CUBITS, ACCORDING TO THE MEASURE OF MAN THAT IS, OF THE ANGEL. ON THE EAST WERE 3 GATES, ON THE NORTH 3 GATES, ON THE SOUTH 3 GATES, AND ON THE WEST 3 GATES;

KINGS 6:31 "TWO ORNATE FOLDING DOORS OVERLAP W/ GOLD SEPARATED THE HOLY & MOST HOLY."

KINGS 7:48 "THE HOLY CONTAINED THE GOLDEN ALTAR OF INCENSE, THE GOLDEN TABLE FOR THE SHOW BREAD, 10 LAMP STANDS S NORTH & S SOUTH."

KINGS 7:21 "HE ERECTED THE PILLARS @ THE PORTICO OF THE TEMPLE. THE PILLAR TO THE SOUTH HE NAMED JACHIN, AND THE ONE TO THE NORTH BOAZ."

KINGS 8:1 "THE MOST HOLY PLACE HOUSED THE ARK OF THE COVENANT WHICH SAT BENEATH THE WINGS OF THE CHERUBIM!"

-THE SKULL IS THE MOST HOLY BONE IN THE BODY.

THE 4 ANGELS IN EZEKIEL 1:10

"AS FOR THE LIKENESS OF THEIR FACES, EACH HAD THE FACE OF A HUMAN, A LION, AN OX AND AN EAGLE."

4 FIXED SIGNS OF ZODIAC



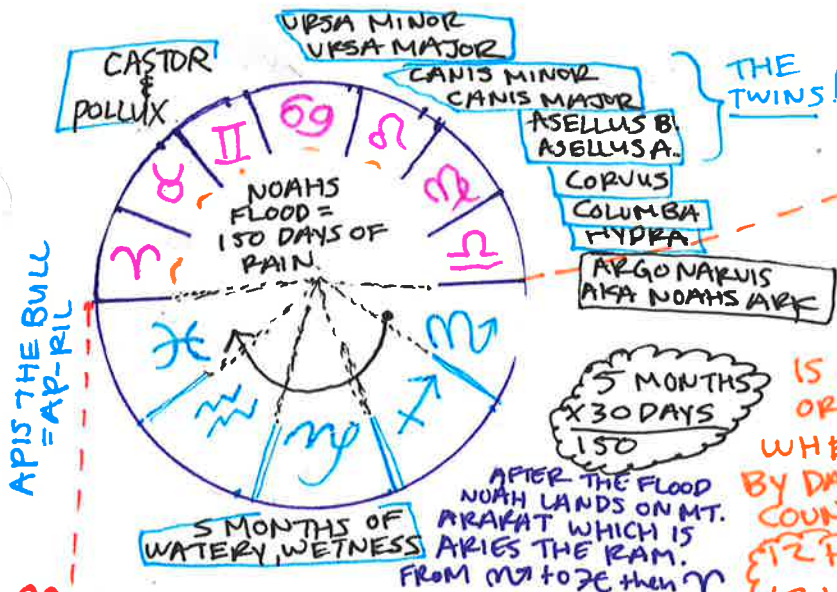

THE ENTRY OF THE SUN INTO LIBRA IN THE NORTH HEMISPHERE MARKS THE AUTUMNAL EQUINOX, WHEN THE DAY AND NIGHT ARE EQUAL ONCE AGAIN, THIS IS THE MOMENT OF EQUILIBRIUM. TISHREI IS THE 7TH MONTH, AND YOM KIPUR IS CELEBRATED (ATONEMENT DAY) OR JUDGEMENT DAY... BALANCE! WHEN THE FORCES SYMBOLIZED BY DAY AND NIGHT ARE IN PERFECT COUNTER POISE. (EQUINOX) EQUAL = NIGHT

12 HOUR DAY  
12 HOUR NIGHT

ARIES WAS CALLED "CRIS CHRYSONALLUS" WHICH MEANS CRIS THE GOLDEN FLEECE RAM." AT THIS TIME OF THE YEAR, THE DAY AND THE YEAR ARE CRITICIZED, OR JUDGED...

IN MODERN COURT ROOMS, THE JUDGE WEARS A SHEEP'S WIG, NEXT TO A BALANCE SCALE REPRESENTING THE BALANCE OF ARIES THE RAM, AND LIBRA THE SCALES.

OSIRIS WAS THE GOD OF THE UNDERWORLD AND HE SYMBOLIZED THE ALPHA AND OMEGA, TODAY'S JUDGES ARE PLAYING AS GOD, BECAUSE THEY CAN SET YOU FREE OR SEND YOU TO JAIL/HELL.

JEWES APRIL 10<sup>TH</sup> PESACH

MUSLIMS APRIL 2<sup>ND</sup> RAMADAN

CHRISTIANS APRIL 4<sup>TH</sup> EASTER

HINDUS APRIL 10<sup>TH</sup> RAMANAVAMI

SHINTOS APRIL 10<sup>TH</sup> ONTOHSAI

QURAN - SURAH AL-BAQARAH "THE HOLY MONTH OF RAMADAN, IN WHICH WAS REVEALED THE HOLY QURAN, A GUIDANCE FOR MANKIND, AND CLEAR PROOFS FOR THE GUIDANCE, AND THE CRITERIA BETWEEN THE RIGHT AND WRONG.

THE STORY OF JESUS WAS ORIGINATED BY OBSERVING THE STARS. - AND BODY.

THE SUN IS BORN OF A VIRGIN **AUG 21**

THE SUN IS CRUCIFIED IN LIBRA **SEP 21**

HE DIES FOR 3 DAYS **DEC 21**

IS REBORN **DEC 25** - 30 DAYS AFTER

DEC 21 IS **JAN 21** AQUARIUS, THATS

WHY JOHN THE BAPTIST SHOWS UP 30 YEARS AFTER JESUS' BIRTH,

HE THEN MEETS HIS DISCIPLES FROM

THE FISHER OF MEN THATS PISCES **FEB 21**

THEN HES THE LAMB OF GOD IN ARIES **MAR 21**

AND HE BECOMES THE LION OF THE TRIBE OF JUDAH LEO **JULY 21**

JESUS WAS CALLED THE LAMB OF GOD "AMNOS" TWICE IN THE BOOK OF JOHN, AFTER THAT JESUS GETS BAPTIZED AND IS CONTINUALLY ASSOCIATED WITH FISH.

THE FISH OF PISCES MARKS THE TIME WHEN JESUS WAS BORN @ THE END OF THE AGE OF ARIES.

THE 4 HORSEMEN OF THE APOCALYPSE EPOCH / EPOCA SEASON

- 1 MONOCEROS ♄ PALE HORSE ♈
- 2 CENTAURUS ♎ WHITE HORSE ♋
- 3 SAGITTARIUS ♐ RED HORSE ♌
- 4 PEGASUS ♈ BLACK HORSE ♍

" ALL OF THE PHILOSOPHIES, RELIGIONS & SCIENCES ARE 'I' " SANTOS BONACCI

ITS BLATANT WHEN YOU READ THE GOSPELS AND YOU KNOW THE STARS, WHAT THEY DO, AND WHAT THEY MEAN, ITS ALL THERE IF YOU'RE NOT SEEING IT, YOUR NOT LOOKING. - SANTOS BONACCI



IN THE BOOK OF MARK

~HARMONIOUS~  
HOLY MEANS TO BE WHOLESOME

THE SPIRIT OF THE LORD IS UPON ME BECAUSE HE HAS ANOINTED ME TO PREACH THE GOSPEL TO THE POOR;  
LUKE 4:19 - JESUS CAME... TO PROCLAIM THE ACCEPTABLE YEAR OF THE LORD.

ARIES 1:1-3:35 - THE BEGINNING OF THE STORY OF JESUS, THE SUCCESSOR TO KING DAVID, BAPTISM, MINISTRY BEGINS.

TAMRUS 4:1-4:4 THE PARABLE OF THE SOWER, GROWTH, LIGHT.

GEMINI 4:35-6:29 WINDSTORM, JESUS RESTORES AN IMPURE SPIRITED MAN, AND SENDS OUT THE 12 DISCIPLES BY TWOS.

CANCER 6:30-8:29 5,000 FED, 5 BREAD LOAVES AND 2 FISH, 12 BASKETS

LEO 8:9-9:29 AFTER SIX DAYS PETER JAMES AND JOHN WERE LED UP A HIGH HILL WHERE JESUS WAS TRANSFIGURED, GLORY, KINGSHIP

VIRGO 9:27-9:50 JESUS TOOK A LITTLE CHILD IN HIS ARMS AND SAID WHOEVER WELCOMES ONE OF THESE LITTLE CHILDREN IN MY NAME WELCOMES ME.

LIBRA 10:1-10:31 IS IT LAWFUL FOR MAN TO DIVORCE HIS WIFE? WHEN A MAN LEAVES HIS PARENTS TO BE WITH HIS WIFE THEY ARE ONE FLESH

SCORPIO 10:32-10:52 JESUS PREDICTS HIS DEATH JESUS PRAYS AT THE MT OF OLIVES WITH THE 12 DISCIPLES

SAGITTARIUS 11 JESUS ENTERS JERUSALEM ON A COLT (HORSE/DONKEY)

CAPRICORN 11:27-12:44 JESUS' AUTHORITY IS QUESTIONED.

AQUARIUS 13:1-14:6 A WOMAN CAME WITH A VERY EXPENSIVE PERFUME SHE BROKE THE JAR AND POURED THE PERFUME ON HIS HEAD. JESUS SAYS TO THE DISCIPLES "GO INTO THE CITY AND A MAN CARRYING A JAR OF WATER WILL MEET YOU, FOLLOW HIM INTO THE HOUSE HE ENTERS."

PISCES 15:21 THE CRUCIFICTION OF JESUS

JOB 38:31 "CANST THOU BIND THE SWEET INFLUENCES OF THE PLEIADES OR LOOSE THE BANDS OF ORION? CANST THOU BRING FORTH THE MAZZEROTH IN ITS SEASON? OR CANST THOU GUIDE ARCTURUS WITH HIS SONS?"

7 HEROS OF THE ECLIPIC - ♈ PERSEUS - ♉ OPHIUCHUS - ♊ BOOTES - ♋ ORION  
♌ ACEPHEUS - ♍ HERCULES - ♎ AURIGA

PSALMS 84:11 FOR OUR GOD IS A SUN. PSALMS 50:1 HIS POWER IS FROM THE RISING OF THE SUN UNTIL THE GOING DOWN THEREOF.

HEBREWS 12:29 FOR OUR GOD IS A CONSUMING FIRE.

ECCLESIASTES 11:7 TRULY THE LIGHT IS SWEET AND A PLEASANT THING IT IS FOR THE EYES TO BEHOLD THE SUN.

MALACHI 4:2 BUT UNTO YOU THAT FEAR MY NAME SHALL THE SUN OF RIGHTEOUSNESS APPEAR WITH HEALING IN ITS WINGS.

JOHN 1:9 GOD IS LIGHT AND IN HIM THERE IS NO DARKNESS

LUKE 2:21 AND WHEN THE 8 DAYS WERE COMPLETE FOR THE CIRCUMCISION OF THE CHILD, HIS NAME WAS CALLED JESUS.

THE SUN CUTS THE CIRCLE OF THE YEAR ON JANUARY 1ST ACCORDING TO TODAY'S MODERN CALENDAR.

THE SUN IS STILL ON THE WINTER SOLSTICE DEC 21ST FOR 3 DAYS

AND BEGINS TO MOVE ALONG ITS TRAJECTORY TOWARDS THE NORTH HEMISPHERE ON DEC 25TH

MARK 9:2 "6 Days later... HIS CLOTHES BECAME DAZZLINGLY WHITE, WHITER THAN ANY EARTHLY BLEACHER CAN MAKE THEM." AUG 6TH - LEO

25, 26, 27, 28, 29, 30, 31, 1  
8 WHOLE DAYS

JESUS IS JUPITER THE SUN IN PISCES MATTHEW 28:20 - I AM WITH YOU TO THE CLOSE OF THE AGE.

GENESIS 49:13 ZEBULUM  
"ZEBULUM IS THE HAVEN OF THE SEA."

GENESIS 49:17 DAN  
"DAN IS A SERPENT BY THE WAY THAT BITETH THE HORSES HEEL."

GENESIS 49:24 "HIS BOW ABODE" JOSEPH

GENESIS 49:5 II SIMON AND LEVI  
"THEY ARE BROTHERN."

JUDAH GENESIS 49:9 "JUDAH IS A LIONS WELP."

INNER UNDERSTANDING LITERATURE. ITS NOT LITERAL!

-R.I.P. Jordan Maxwell "The Bible is the Greatest Story Ever Told, But that's all it is... A STORY."

ARE THE 12 SONS OF JACOB, ARE THE 12 TRIBES OF ISRAEL, ARE THE 12 SIGNS OF THE ZODIAC!



JOHNS VISION OF CHRIST

**REVELATION 1:9** "I JOHN YOUR BROTHER AND COMPANION IN THE SUFFERING AND KINGDOM AND PATIENT ENDURANCE THAT ARE OURS IN JESUS, WAS ON THE ISLAND OF PATMOS BECAUSE OF THE WORD OF GOD, AND THE TESTIMONY OF JESUS. ON THE LORDS DAY I WAS IN THE SPIRIT AND I HEARD BEHIND ME A LOUD VOICE LIKE A TRUMPET WHICH SAID "WRITE ON A SCROLL WHAT YOU SEE, AND SEND IT TO THE 7 CHURCHES. TO **EPHESUS, SMYRNA, PERGAMUM, THYATIRA, SARDIS, PHILADELPHIA, AND LAODICEA.** I TURNED AROUND TO SEE THE VOICE THAT WAS SPEAKING TO ME, AND WHEN I TURNED I SAW 7 GOLDEN LAMP STANDS. AMONG THE LAMP STANDS WAS SOMEONE LIKE A SON OF MAN, DRESSED IN A ROBE, REACHING DOWN TO HIS FEET, AND WITH A GOLDEN SASH AROUND HIS CHEST. THE HAIR ON HIS HEAD WAS WHITE LIKE WOOL, AS WHITE AS SNOW, AND HIS EYES WERE LIKE BLAZING FIRE, HIS FEET WERE LIKE BRONZE GLOWING IN A FURNACE, AND HIS VOICE WAS LIKE THE SOUND OF PUSHING WATERS. IN HIS RIGHT HAND HE HELD 7 STARS AND COMING OUT OF HIS MOUTH WAS A SHARP, DOUBLE EDGE SWORD. HIS FACE WAS LIKE THE SUN SHINING IN ALL ITS BRILLIANCE.

**REVELATION 1:20** "THE MYSTERY OF THE 7 STARS WHICH THEY SAW IN MY RIGHT HAND, AND THE 7 CANDLES/TICKS. THE 7 STARS ARE THE 7 ANGELS OF THE 7 CHURCHES, AND THE 7 CANDLES/TICKS ARE THE 7 CHURCHES."

"IN THE FIRST CHAPTER OF REVELATION, JOHN IS DESCRIBING THE 7 ELOHIM, LUMINARIES!"  
- SANTOS BONACCI

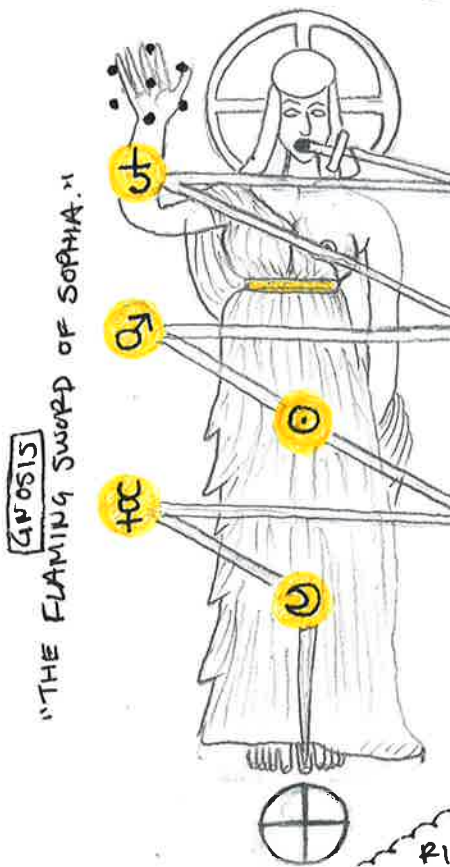

- Ω KRONOS WHITE HAIR
- ♃ ZEUS BLAZING EYES
- ♁ ARÉS SHARP SWORD
- ♄ ILÍOS FACE LIKE THE SUN
- ♀ AFRODÍTI SASH AROUND THE CHEST
- ♁ ERMÉS BRONZE FEET
- ♁ SELENE VOICE LIKE WATER

**REV. 5:1** "I SAW IN THE RIGHT HAND OF HIM THAT SAT ON THE THRONE, A SCROLL WRITTEN WITHIN AND ON THE BACKSIDE SEALED WITH 7 SEALS."

- THE SCROLL IS THE SPINE ..... THE 7 SEALS ARE THE 7 CHAKRAS ALIGNED!  
- DBBD





JUDGED & KICKED OUT OF HEAVEN.

WHEN WE ENTER LIBRA THE SUN IS



PERSEUS - IS SEEN CHASING ADAM & EVE OUT OF THE GARDEN WITH HIS SWORD, BECAUSE IN THE SPRING/SUMMER, ADAM (BOOTES) AND EVE (VIRGO) ARE SEEN IN HEAVEN @ NIGHT. IN FALL & WINTER TIME, PERSEUS RULES HEAVEN, AS HE IS IN THE CONSTELLATION ARIES.

THE TWO ASSES IN THE BARRA ARE DECANUS!



THE SOUTH & NORTH DONKEYS. ASELLUS AUSTRALIS + BOREALIS

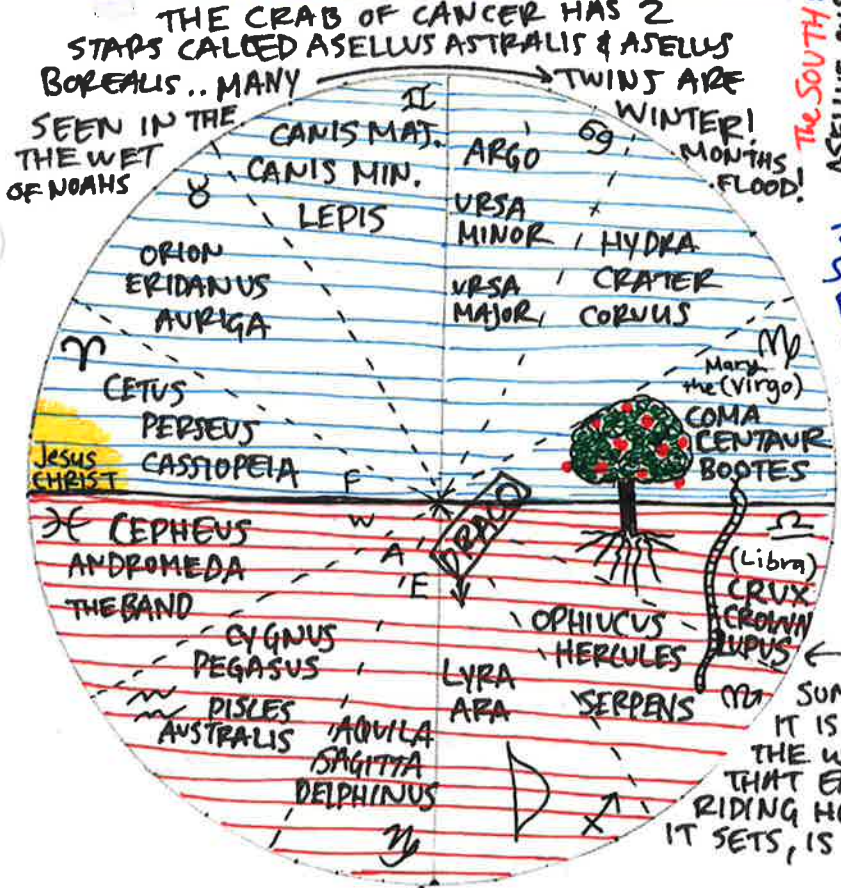

AT MIDNIGHT ON THE WINTER SOLSTICE, LOOK UP AND SEE SIRIUS! - WHICH IS IMPOSSIBLE TO SEE DURING SUMMER BECAUSE SIRIUS IS A STAR IN CANIS MAJOR, WHICH IS A DECAN IN GEMINI.

When the Sun enters  $\text{No}$  on Dec 21st, The Goat Sucks away all of the Sun's Energy. -METAPHORICALLY.

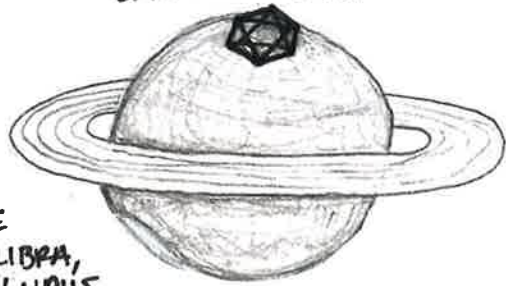

**CAPRICORN**  
THE CHUPACABRA - THE BLOOD SUCKING GOAT.



JESUS, MARY & SIMEON

LUKE 2:21 "AND WHEN THE 8 DAYS WERE COMPLETED FOR THE CIRCUMCISION OF THE CHILD, HIS NAME WAS CALLED JESUS."



JESUS - THE "SUN" OF GOD IS BORN DEC 25<sup>TH</sup> OF EVERY YEAR... 8 DAYS AFTER THE 24<sup>TH</sup> IS JANUARY 1<sup>ST</sup>. THE NEW YEAR BEGINS, AS WE CUT THE CIRCLE TO THE OLD YEAR. CIRCUMCISION



CORONATED = CORONA = CORNU

= HORN

CHRISTENING HAPPENS AT BIRTH OR REBIRTH. "KRST" = EGYPTIAN WORD FOR KING.

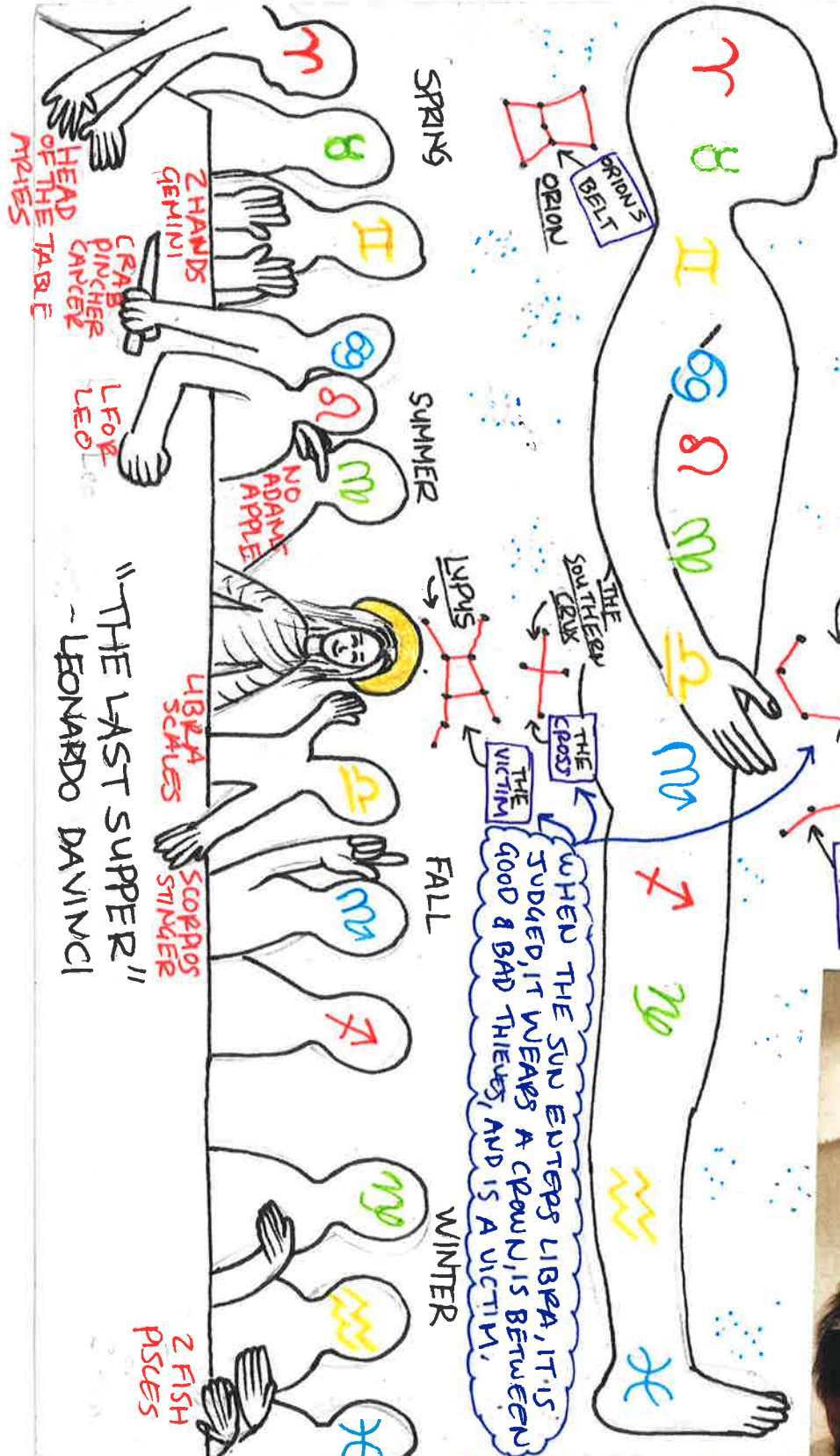

JESUS WEARS A CROWN OF THORNS AS HE DIES ON THE CROSS. THE HORNS OF JESUS ARE A SYMBOL OF HORNS. REBIRTH HAPPENS WHEN THE OLD SELF DIES... JESUS WAS BORN OF MARY BUT CHRIST WAS RAISED BY GOD. @33 HE IS KRSTED & REBORN!



NORTH EAST



SOUTH EAST

DEC 21

PARADISE HEAVEN

INVERNO INFERNO

ITS EASTER WHEN THE SUN RISES DUE EAST. ITS CALLED THE **EQUINOX** BECAUSE THE NIGHT IS EQUAL TO THE DAY... **EQUAL/NIGHT**

THE ROAD OF RECONCILIATION.

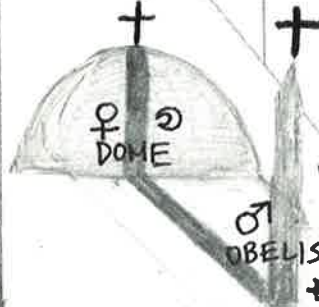

WHEN THE OBELISK (PHALLUS) SHADOW TOUCHES THE DOME (WOMB) - THIS MARKS CONCEPTION, 9 MONTHS LATER IS THE BIRTH OF THE SUN ✨ aka JESUS DECS

REV 12:1



"And there appeared a great wonder in heaven. A woman clothed with the sun, and the moon under her feet, and upon her head a crown of 12 stars."

SHE WAS PREGNANT AND CRIED OUT IN PAIN AS SHE WAS ABOUT TO GIVE BIRTH. THEN ANOTHER SIGN APPEARED IN HEAVEN, AN ENORMOUS RED DRAGON WITH 7 HEADS, 10 HORNS AND 7 CROWNS ON ITS HEADS. ITS TAIL SWEEP A THIRD OF THE STARS OUT OF THE SKY AND FLUNG THEM TO EARTH. THE DRAGON STOOD IN FRONT OF THE WOMAN WHO WAS ABOUT TO GIVE BIRTH, SO THAT IT MIGHT DEVOUR HER CHILD THE MOMENT HE WAS BORN. SHE GAVE BIRTH TO A SON, A MALE CHILD WHO "WILL RULE ALL THE NATIONS WITH AN IRON SCEPTER." AND HER CHILD WAS SNATCHED UP TO GOD AND TO HIS THRONE.



GOOD ↑ CROSS ↓ BAD ↓

"THE WOMAN FLED INTO THE WILDERNESS TO A PLACE PREPARED FOR HER BY GOD, WHERE SHE MIGHT BE TAKEN CARE OF FOR 1,260 DAYS." Revelation 12:6

AGE OF PISCES 1260 YEARS

- ASSUMPTION OF THE VIRGIN AUGUST 15 ♍ VIRGO DISAPPEARS BEHIND THE SUN. ON THE 8TH OF SEPTEMBER MARY IS REBORN.

"THE NATIVITY"

BEHOLD! I CORINTHIANS 15:51 I SHOW YOU A MYSTERY; WE SHALL NOT ALL SLEEP, BUT WE SHALL BE CHANGED IN A MOMENT, IN THE TWINKLING OF AN EYE @ THE LAST TRUMP; FOR THE TRUMPET SHALL SOUND & THE DEAD SHALL BE RAISED.





The Last Supper took place the night before Jesus knew he was to die. During it, he blesses bread, telling his disciples, "Take and eat, this is my body." Then he blesses a cup of wine, saying "Drink from it, all of you. This is my blood of the covenant." Finally, he exhorts them, "do this in remembrance of me."

THE SUN FALLS IN FALL, AND AT THIS TIME IS WHEN ANCIENTS HARVESTED THEIR CROPS, WHEAT FOR BREAD AND GRAPES FOR WINE.

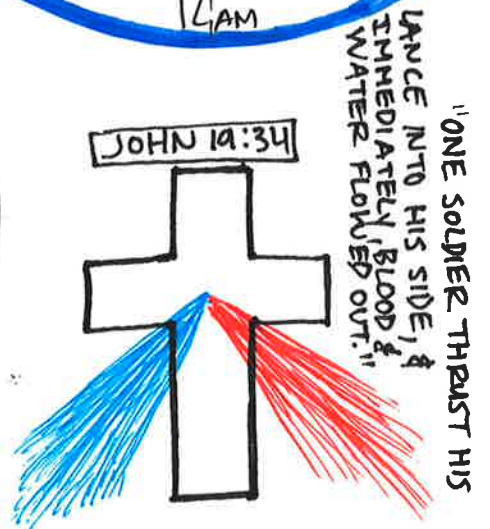
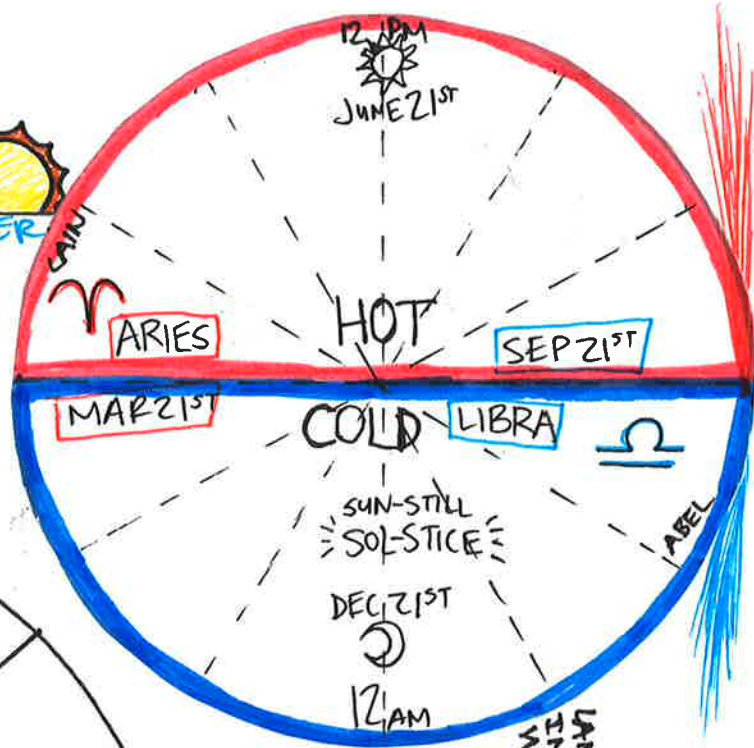
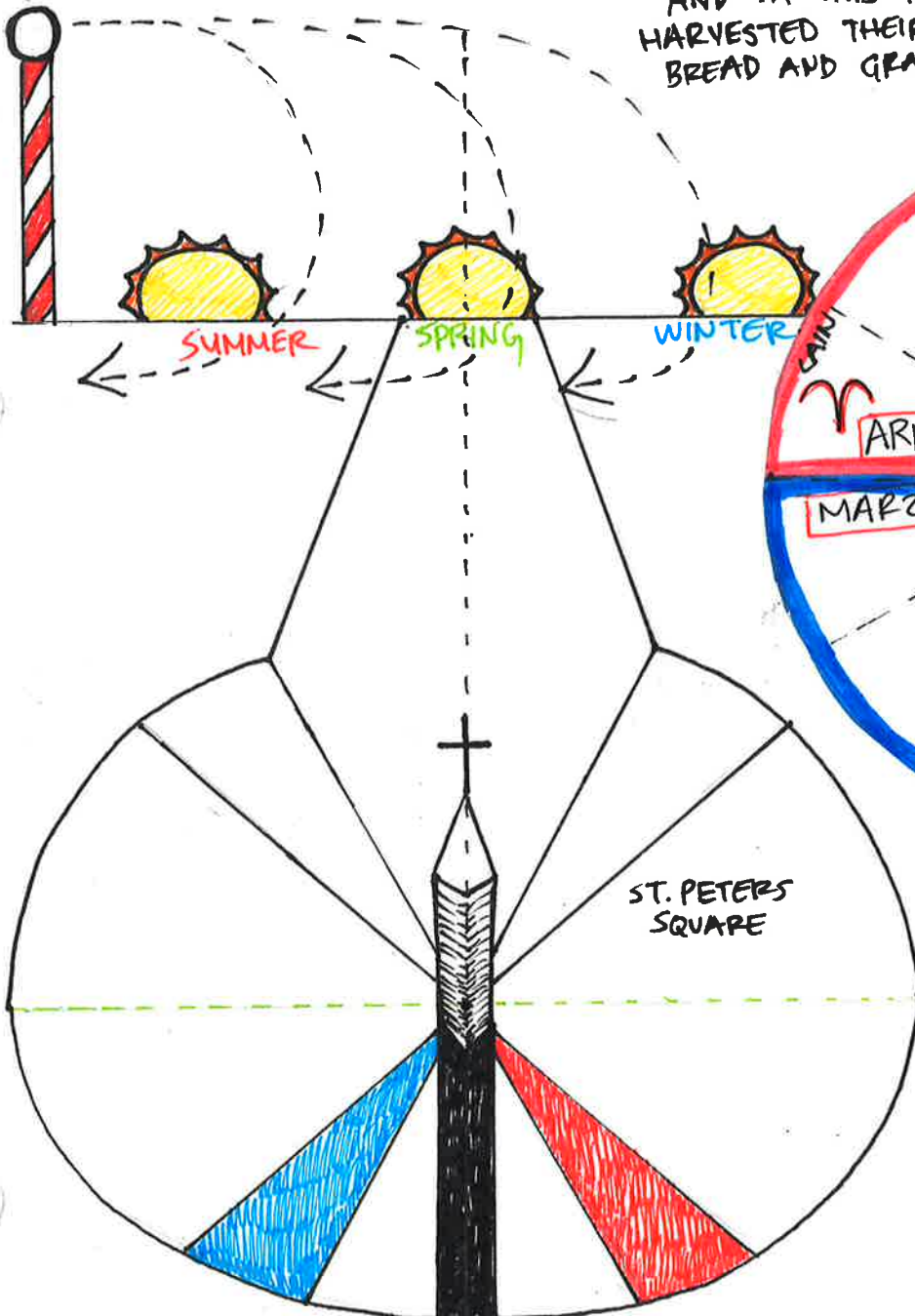

ST. PETERS BASILICA @ THE VATICAN (ROME, ITALY)



PLUTO WILL ENTER **AQUARIUS** 3/24/23 - March 24<sup>th</sup> 2023  
 THEN RETROGRADE ON 5/2/23 - May 2nd 2023 THEN PLUTO  
 WILL BE BACK IN **CAPRICORN** UNTIL 10/11/23 - October 11<sup>th</sup> 2023,  
 IT WILL RETURN TO **AQUARIUS** 1/12/24 - January 12<sup>th</sup> 2024,  
 THEN 1 FINAL RETROGRADE 5/2/2024 - May 2nd 2024 AND  
 ENTER **CAPRICORN** 9/2/24 - September 2nd 2024 UNTIL  
 10/12/24 - October 12<sup>th</sup> 2024 THEN OFFICIALLY ENTERS **AQUARIUS**  
 11/20/24 - November 20<sup>th</sup> 2024.

PLUTO HAS BEEN IN ♎ SINCE 2008 JAN. 25  
 ♎ PLUTO IN ♎ CAPRICORN SINCE 1/25/08

PLUTO RULES SCORPIO - THE 8<sup>TH</sup> HOUSE, ALSO KNOWN AS "HADES"

PLUTO IS THE PLANET OF TRANSFORMATION, IT IS KNOWN AS THE DESTROYER, ITS ENERGY IS POWERFUL, POTENT AND LETHAL. IT RULES THE DEATH AND REBIRTH PROCESS, BRINGING UP OUR DEEPEST, DARKEST PSYCHOLOGICAL PATTERNS AND HIDDEN PSYCHES, TO BE PURGED SO WE CAN TRANSFORM. PLUTO'S VIBRATION IS THAT OF RADICAL CHANGE, ELIMINATION AND DESTRUCTION. HE PRESENTS THE FORCE WHICH DESTROYS OBSSIVE PATTERNS AND HABITS THAT KEEP US STUCK. HE DIGS DEEP AND PULLS UP THE UNSEEN AND HIDDEN SIDES OF OUR NATURE, BRINGING THEM TO LIGHT OF DAY, WHERE HE FORCES US TO FACE THE DARK KNIGHT OF THE SOUL, IN ORDER TO TRANSFORM AND BRING ABOUT DEEP HEALING.

THE INTERPRETATION OF PLUTO IN A SIGN APPLIES TO A WHOLE GENERATION RATHER THAN THE INDIVIDUAL. RELATING TO THE EXPRESSIONS OF PLUTO ARE; **POWER, RADICAL CHANGE, UNVAISH TRUTH, COMPULSIVE, MANIPULATIVE, OBSSIVE.**

PLUTO SPENDS 12-32 YEARS IN EACH SIGN, AND TAKES 248 YEARS TO DO A FULL CYCLE IN EACH SIGN.

PLUTO HAS BEEN IN CAPRICORN SINCE 1/25/08.

**CAPRICORN** RULES THE PUBLIC LIFE, ITS THE 10<sup>TH</sup> HOUSE, IT RULES SOCIAL STANDARDS, ENTERTAINMENT, MUSIC AND OTHER INDUSTRIES, WHERE CONSUMERISM IS IMPORTANT. THE EXPRESSIONS OF CAPRICORN ARE; **STRUCTURE, STATUS QUO, GOVERNMENTAL BODIES, POLITICS, MATERIALISM, AUTHORITARIANISM, DISCIPLINE, HARDWORK, CAREER, ENTERPRISE, SOCIAL STATUS.**

IT IS THESE AREAS OF THE WORLD THAT HAVE BEEN AND ARE STILL GOING THROUGH RADICAL CHANGES, WE HAVE SEEN POWERFUL TRANSFORMATIONS IN OUR DAILY LIVES, MAJOR BREAKDOWNS, AND RESTRUCTURING OF OUR SOCIETAL CONSTRUCTS. 2012, 2016, 2020



5 RED STARS

- ARCTURUS ♋ BOOTES
- ANTARES ♏ SCORPIO
- BETELGEUSE ♌ ORION
- ALDEBARAN ♉ TAURUS (The Eye of the Bull)
- MARS ♂

↓ AND SOMETIMES  
 • ROSH SATAN ♎ (Perseus)

- SANTOS BONACCI

SANTOS BONACCI - "WAKE UP! YOUR SOUL IS OWNED BY THE VATICAN, YOU GOT A TRUST FUND UNDER YOUR NAME, THAT THE CATHOLIC CHURCH MAKES MONEY FROM. HATED BANNED MONEY GOES TO TAXES, AND THE GOVERNMENT CHURCH CORPORATION ITS A MONETARY SYSTEM THAT PROFITS THE PRIESTS OF BABEL!!"



ST. MICHAEL



WIKIFER

HORUS



OSIRIS ISIS



KRONOS



SATURN

ZEUS



VENUS



MAAT ANNUBIS

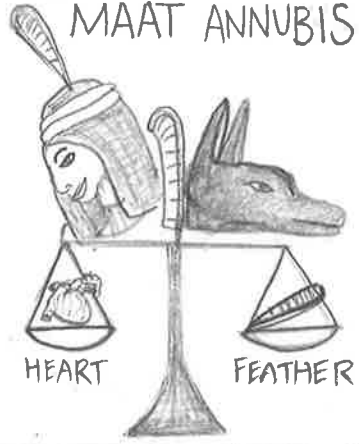

HEART

FEATHER

WASHINGTON



HERMES



JUSTITIA



THOR



THEMIS



JESUS CHRIST



LIBERTY



← 7

9/11

← 11

ST. PETER



BAPHOMET



OSIRIS



HORUS



ISIS



SET



SURTUR



ODIN



THOR



FRIGGA



CHRONUS



ZEUS



RHEA



SATURN



JOSEPH



JESUS



MARYA



SATAN



BUDDHA



MAYA



SAME DIETIES





SHIVA EYE - OLHO DE SHIVA

The pentagram on the forehead Baphometh symbolizes, the awakened of the Woman and the Man, on your 5 Senses and Five elements, awakened by the activity of the pituitary, by real practice ancient knowledge.



Wotan the Winged One-Eyed God!

HORUS THE WINGED ONE-EYED GOD





"JESUS THE NAZARENE KING OF THE JEWS."  
 IESOUS **FALSE X**  
 NAZERENVS  
 REX  
 IUDAERVM

OCCULT=HIDDEN IN PLAIN SIGHT

SECRET SYMBOLS  
 ROSICRUCIANS  
 1785



YH'S'WH  
 THE PENTAGRAMMATON  
 "THE 5 LETTER WORD  
 OF GOD."

ATONEMENT  
 = ATON + MENT  
**GOD-MIND**  
 A BALANCED MIND

SEPTEMBER  
 "YOM KIPPUR"  
 Atonement  
 Day

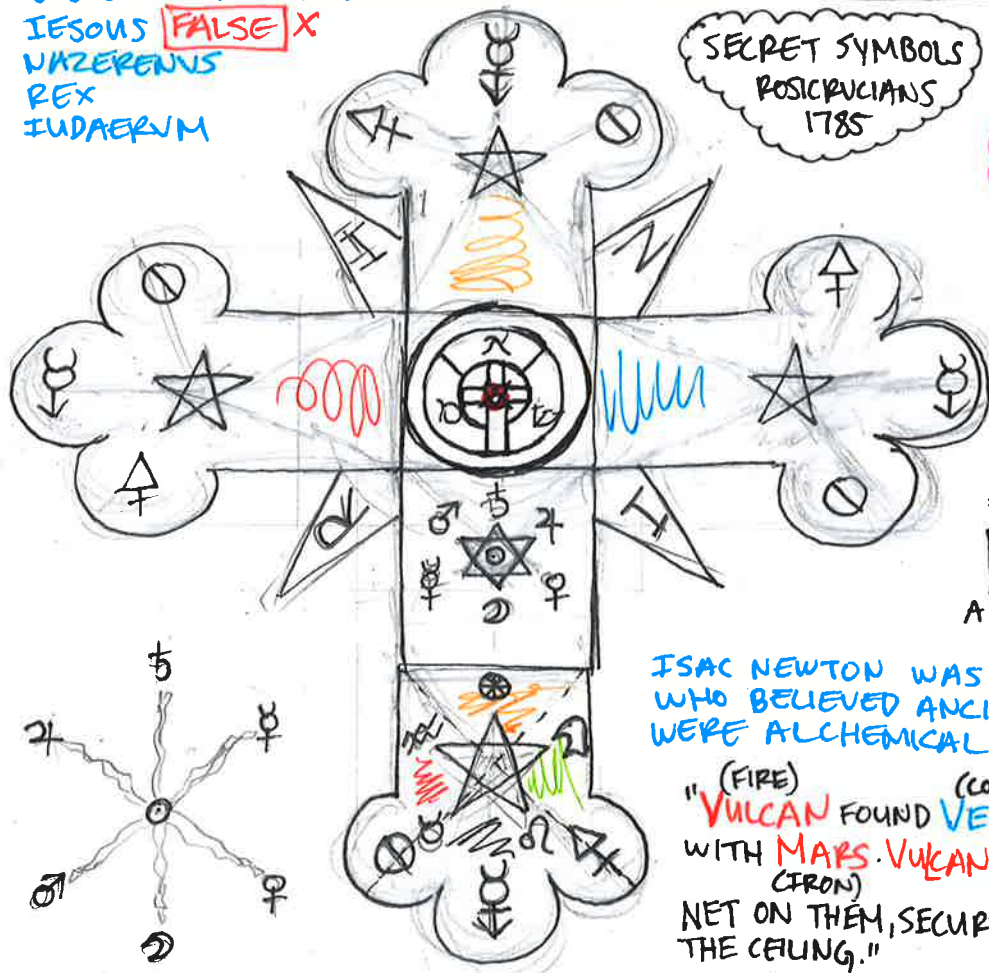

ISAC NEWTON WAS AN ALCHEMIST  
 WHO BELIEVED ANCIENT LEGENDS  
 WERE ALCHEMICAL RECIPES.

"(FIRE) VULCAN FOUND (COPPER) VENUS IN BED  
 WITH (IRON) MARS. VULCAN CAST A SILVER  
 NET ON THEM, SECURING THEM TO  
 THE CEILING."

BRONZE = COPPER + TIN  
 ♀ 4

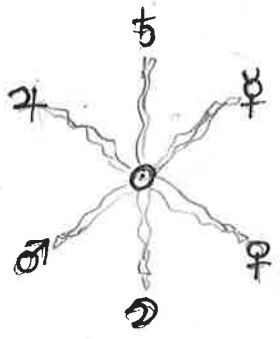

IGNE NATURA RENOVATUR INTEGRA  
 INBI NATURA RENOVATUR  
 BY FIRE, COMPLETION  
 CORRECT

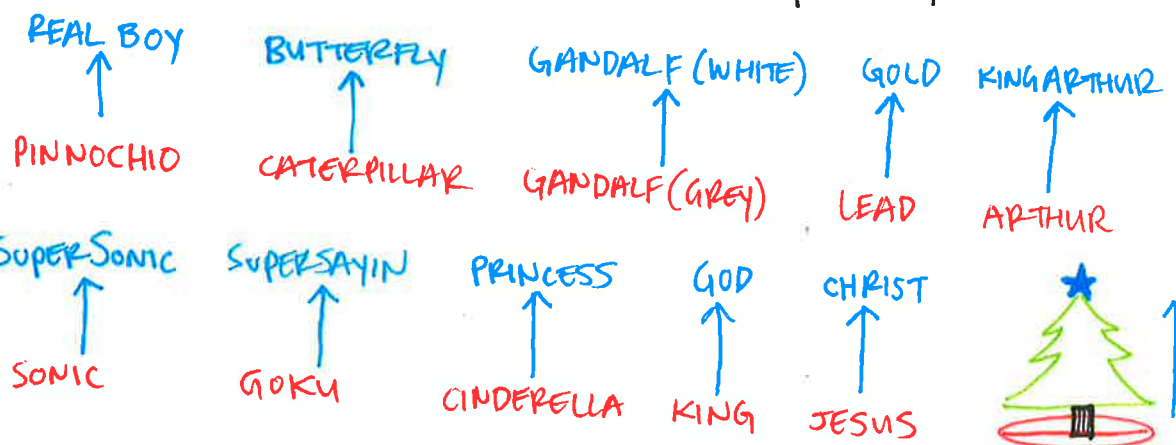

SANTA GOES DOWN  
 THE CHIMNEY THEN  
 BACK UP!

THOR IS THE ONLY ONE  
 WORTHY TO LIFT THE  
 HAMMER....  
 AR-THUR IS THE ONLY  
 ONE WORTHY TO LIFT  
 THE SWORD OUT OF THE  
 STONE....

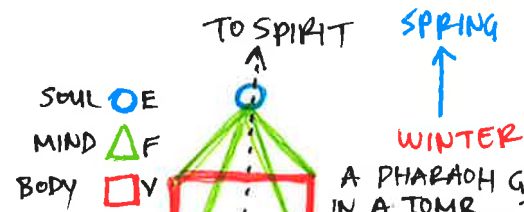

A PHARAOH GETS BURIED  
 IN A TOMB.... THE SPIRIT  
 BECOMES ONE WITH THE  
 ETERNAL SOURCE CONSCIOUSNESS,  
 UP THE 4 EDGES OF THE PYRAMID,  
 FROM EARTH TO AETHER.

ENLIGHTENMENT IS THE  
 END PRODUCT OF THE  
 MAGNUM OPUS aka  
 "THE GREAT WORK"

-The philosophers Stone.... IS YOU!

"Jesus was not a real historical  
 person of the Roman period, it's  
 the part of you that you must  
 find within you and awaken."  
 -Sanjosh Boreari



**PA FATHER**  
Beth Aleph  
2 1  
AB=3

**IS MOTHER**  
Mem Aleph  
40 1  
AM=41

**EL CHILD**  
Daleth Lamed Yod  
4 30 5 10  
YALIED=44

**GARDEN**  
Mem Daleth Kof  
40 4 100  
KADEM=144

**TREE OF LIFE**  
Mem Yod Yod Aleph Heh Tz Ayin  
40 10 10 8 5 90 70  
ETZ HAYIM=233

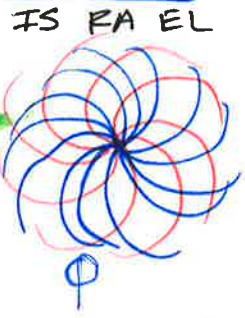

Movie  
1998 Pi

$233 \cdot 1.144 = 1.618$

JOHN 15:5  
"I AM THE VINE,  
YOU ARE THE  
BRANCHES."

- ♃ Greater Benefic **Wet/Hot**
- ♀ Lesser Benefic **Cold/Wet**
- ♂ Greater Malefic **Cold/Dry**
- ♁ Lesser Malefic **Hot/Dry**

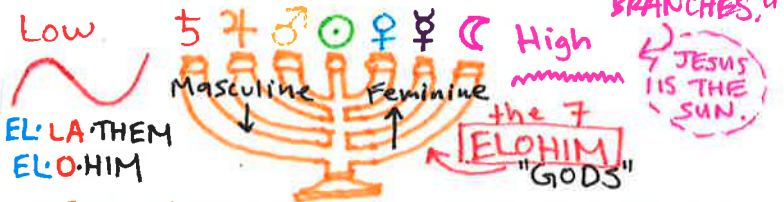

THE 7 PLANETS WERE THE 7 OLD GODS OF THE BABYLONIANS. THEY WERE REPRESENTED AMONG THE JEWS, EGYPTIANS AND PERSIANS BY 7 BRANCHED CANDLESTICKS (MENORAH) OR SEVEN FLAMED ALTAR FIRES.

- Harry Potter vs Draco Lucious Malfoy
- Thor - vs Surtur, Hela
- Jupiter - vs Saturn
- Horus - vs Set
- Luke - vs Darth Vader
- Zeus - vs Kronos
- Enlil - vs Enki
- Gandalf - vs Balrog
- ST Peter - Malchus
- Superman - Lex Luther
- Peter Pan - vs Captain Hook
- Jesus - vs Satan
- Peter pevensie - vs Jadis
- Peter Quill - Ego the Living Planet
- Peter Parker - Electro, Lizard, Goblin

♄ Saturn  
5 = Lamed  
Letter "L"  
in Hebrew  
EL = GOD  
KAL-EL = SON OF GOD  
SUPERMAN

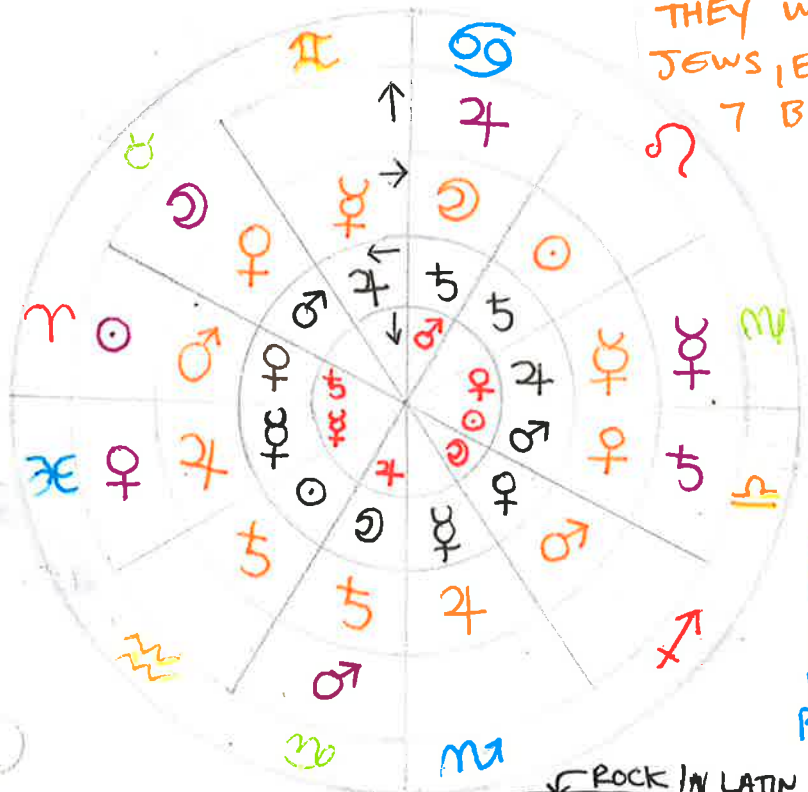

ROCK IN LATIN  
Petros = Jesus  
↑ JEDI JUST | SITH SINISTER ↓  
[Psalm 18:2] "The lord is my rock, my fortress and my savior!"



THE BODY BECOMES A MAGNET BY PUMPING CURRENT UP THE SPINE TO PRODUCE AN ELECTROMAGNETIC FIELD. RELEASE ENERGY FROM THE BASE OF THE SPINE TO THE TOP OF THE HEAD. -CHAKRA ALIGNMENT IS LIKE A BUNDLE OF RODS IN A FASCES.

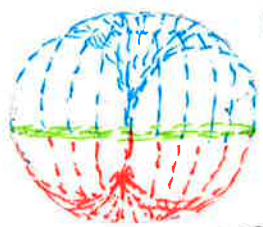
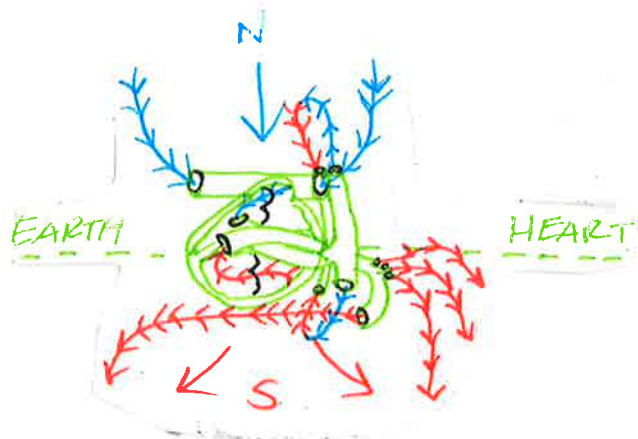

AWAY ♂ OXYGENATED ARTERIAL SYSTEM  
 ♡ VENUS SYSTEM  
 TO ♀ DEOXYGENATED

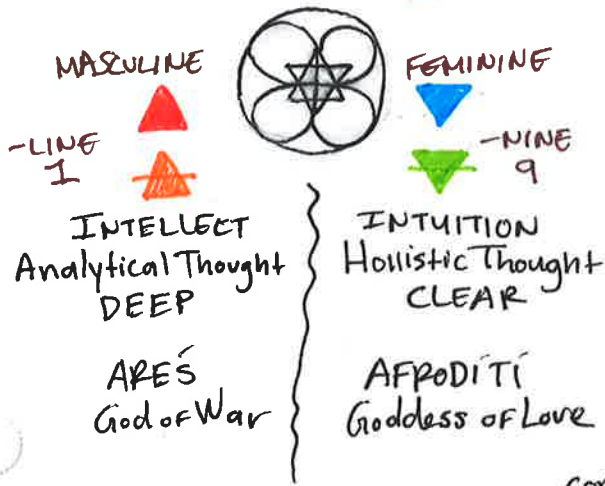
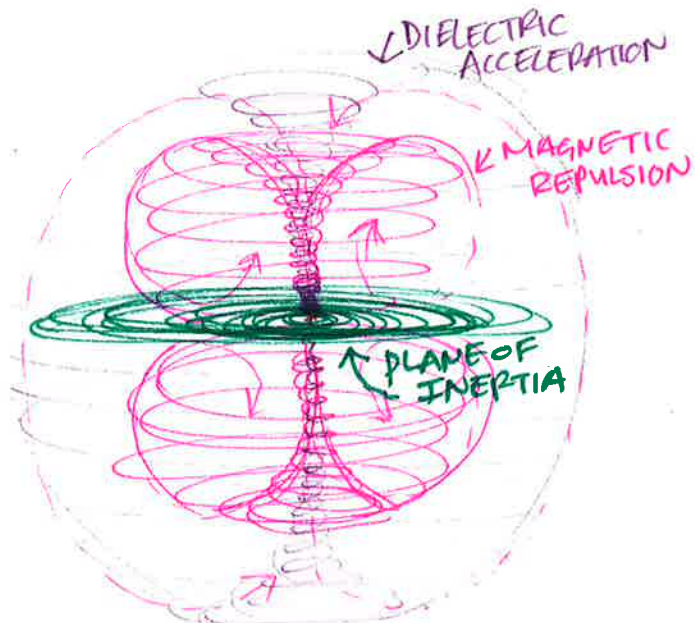

THE TORUS IS THE FORM OF FLOWING ENERGY DYNAMICS AT EVERY SCALE OF EXISTENCE THE 3D STRUCTURE OF THE TORUS IS THE VECTOR EQUILIBRIUM. ITS THE BLUE PRINT BY WHICH NATURE FORMS ENERGY INTO MATTER. WE CAN OBSERVE IT EVERY WHERE IN ATOMS, CELLS, JEEDS, FLOWERS, TREES, ANIMALS, HUMANS, HURRICANES, PLANETS, GALAXIES & EVEN THE COSMOS AS A WHOLE.

THE HUMAN RESONANCE IS DIRECTLY TIED TO THE SCHUMANN RESONANCE, THE EARTH'S CORE EXHIBITS A RESONANCE @ A CERTAIN FREQUENCY (7.8 ELF STANDING WAVE)



"ARCHANGEL"

ANGLES

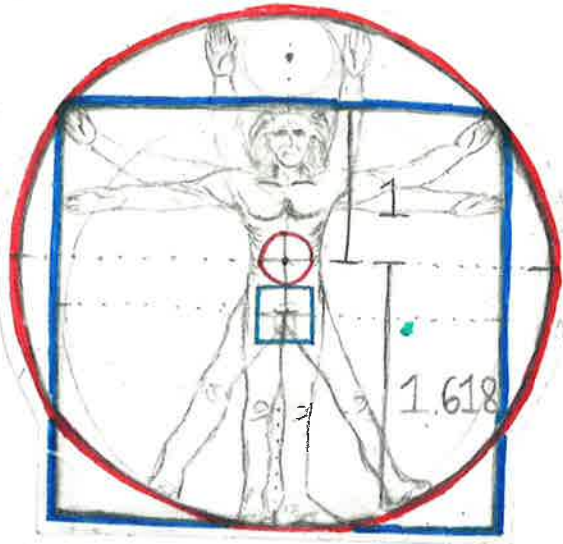
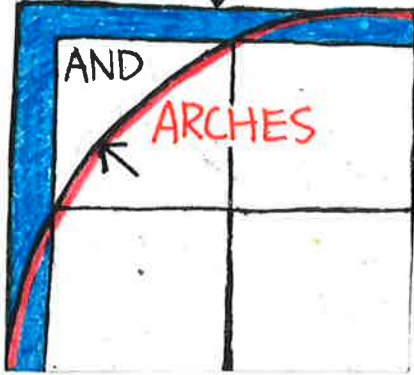

Golden Rectangle

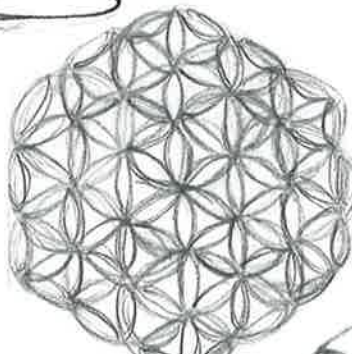
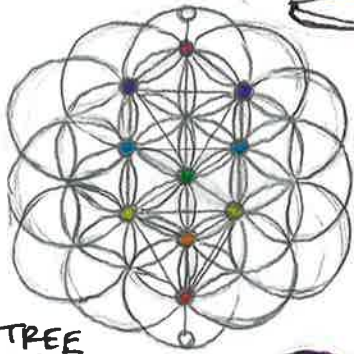
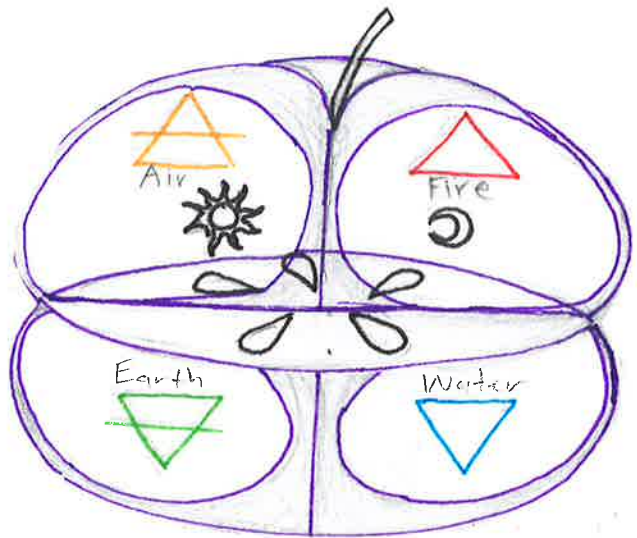
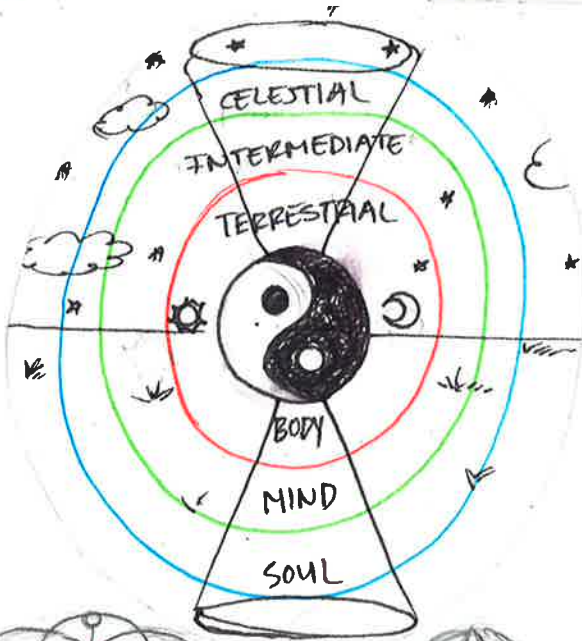
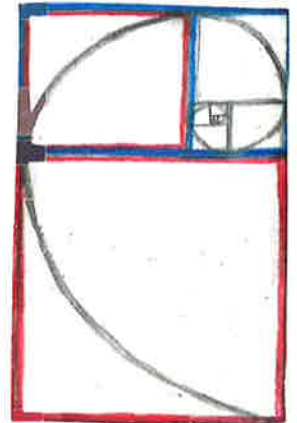

TREE OF LIFE



Daisy of Death

FLOWER OF LIFE

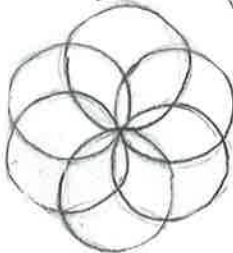

SEED OF LIFE



GERM OF LIFE



EGG OF LIFE

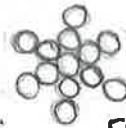

FRUIT OF LIFE

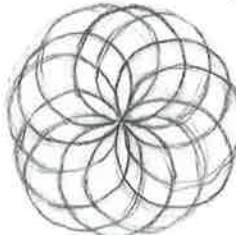

LOTUS OF LIFE



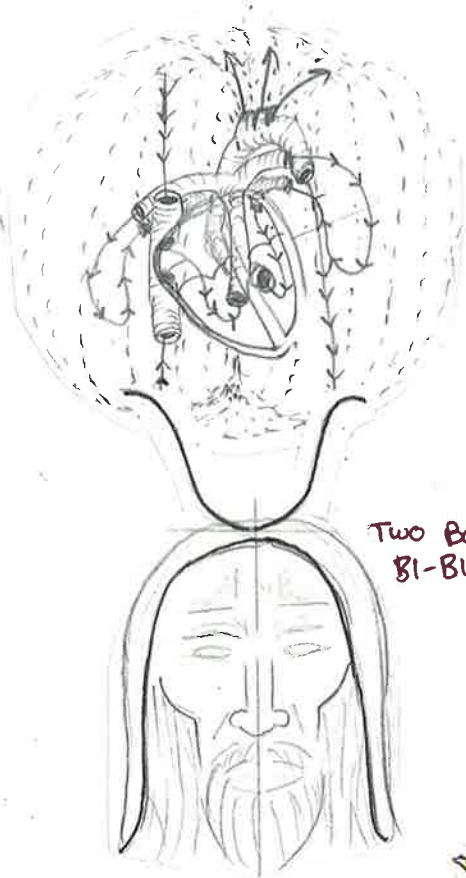

TWO BOWLS  
BI-BLE

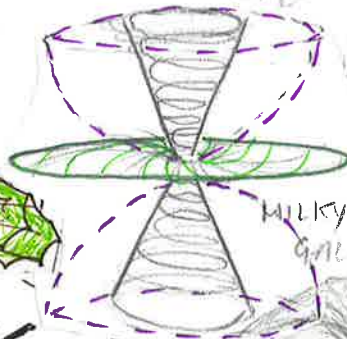
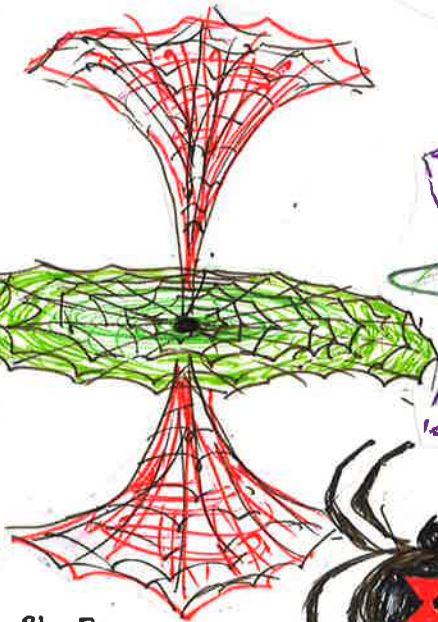
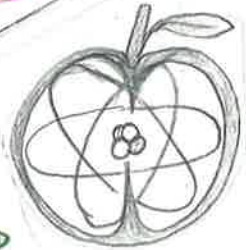
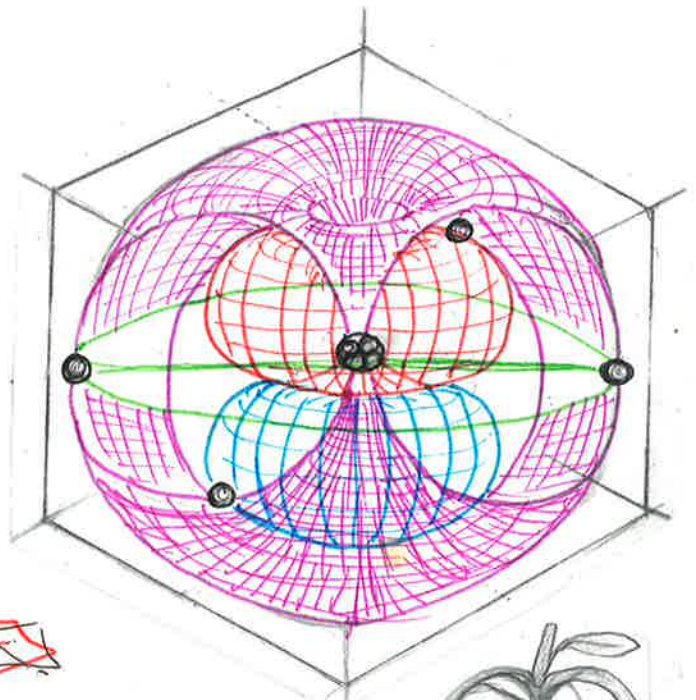
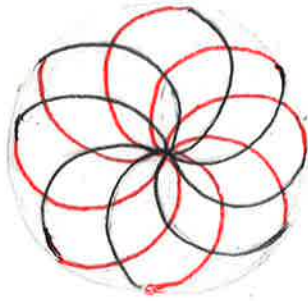

MILKY WAY  
GALAXY

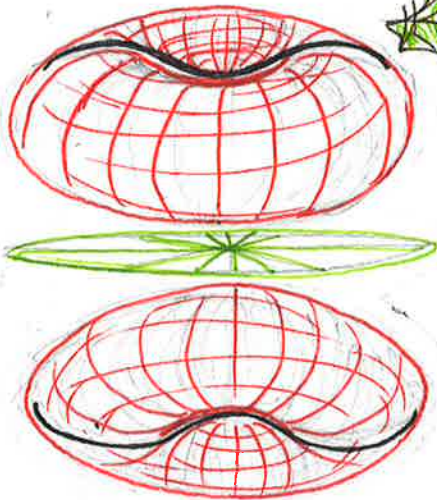

BL-BOL  
BLOOD CELL



BLACK WIDOW

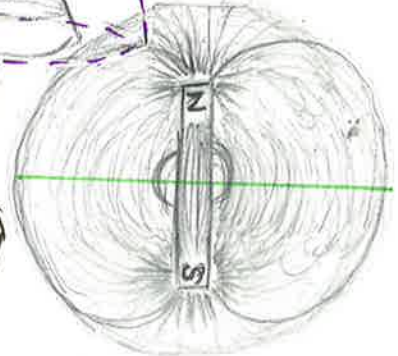

THE 'KAABA' STONE  
IN MECCA, ARABIA

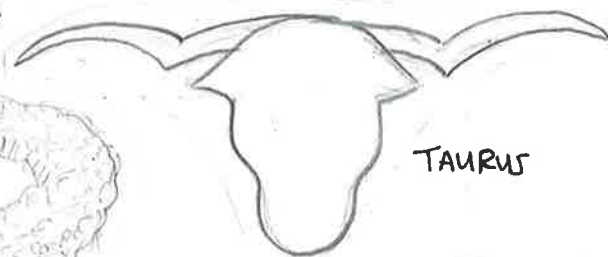
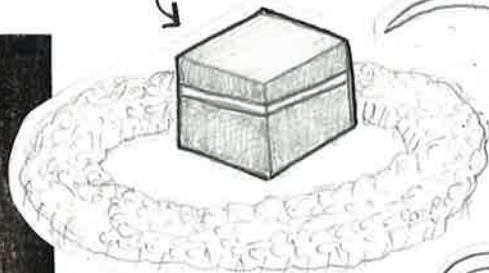

TAURUS

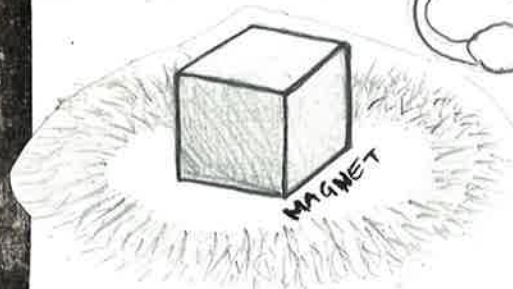

MAGNET

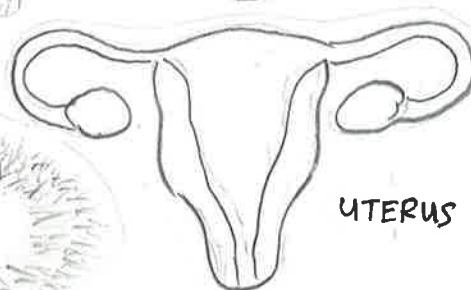

UTERUS



"JESUS"  
← SHROUD OF TURIN (EVERYTHING IS TOR-US FIELDS)

JESUS SPEAKS IN PARABLES!

PAIR OF  
BOWLS



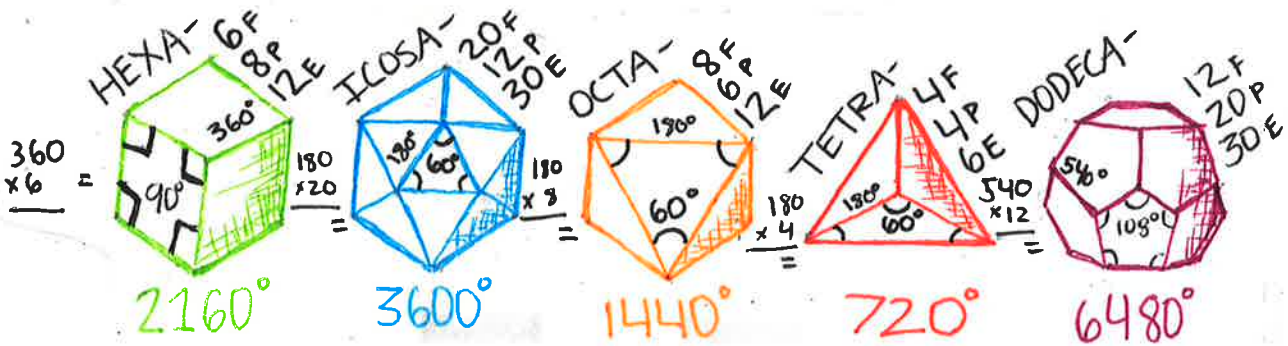

<b>EARTH</b> CARBON MOLECULE SOLID SOLIDITY • SENSE MINERAL SMELL	<b>WATER</b> Hydrogen ATOM LIQUID COHESION • EMOTION PLANT TASTE	<b>AIR</b> OXYGEN PARTICLE GAS MOTION • MIND ANIMAL HEARING	<b>FIRE</b> NITROGEN PHOTON PLASMA TEMPERATURE • SPIRIT HUMAN SIGHT	<b>AETHER</b> CONSCIOUSNESS ENERGY DIELECTRICITY DIMENSION • LOVE ANGEL TOUCH
--	---	--	--	--

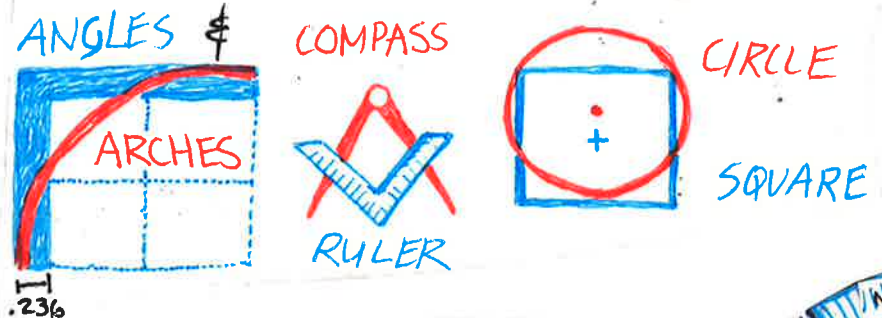

OXYGEN 65%  
 CARBON 18.5%  
 HYDROGEN 9.5%  
 NITROGEN 3.3%  
 CALCIUM 1.5%  
 PHOSPHORUS 1%  
 POTASSIUM 4%  
 SULFUR 3%  
 CHLORINE 2%  
 SODIUM 2%  
 MAGNESIUM 1%  
 IODINE 1%  
 ZINC 1%

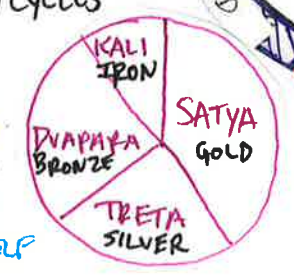
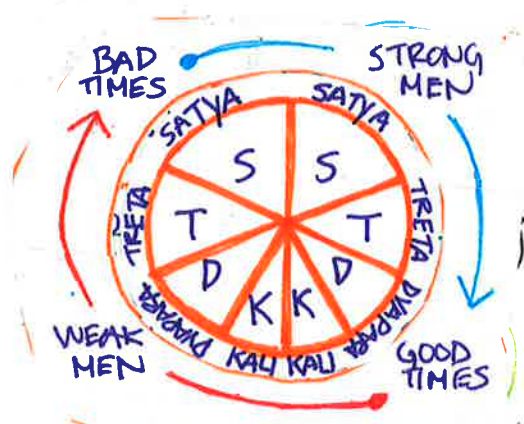
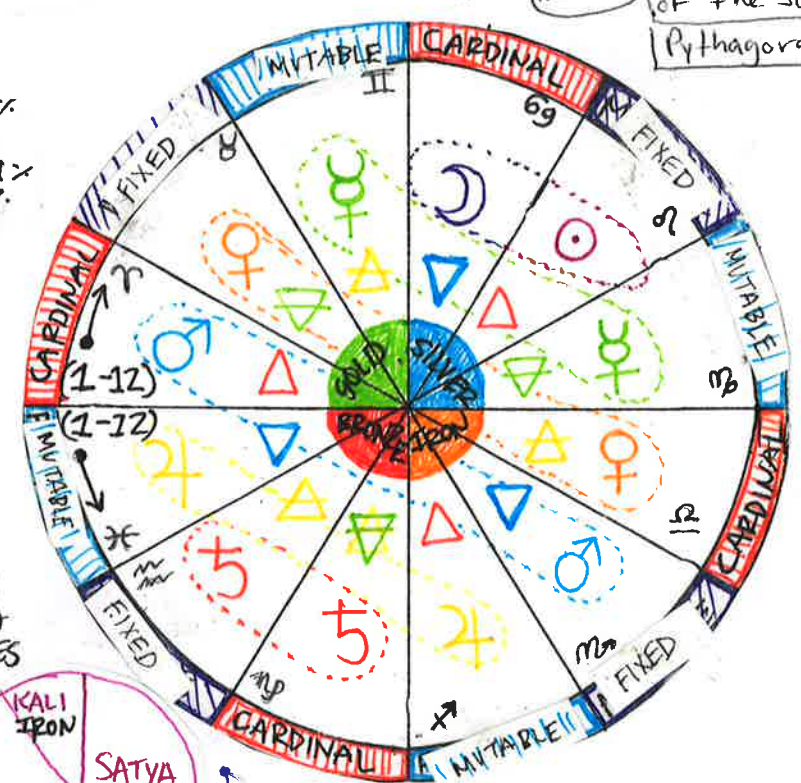

SELFISH - LOWER SELF  
 SELFLESS - HIGHER SELF



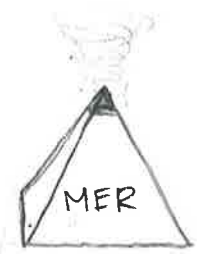
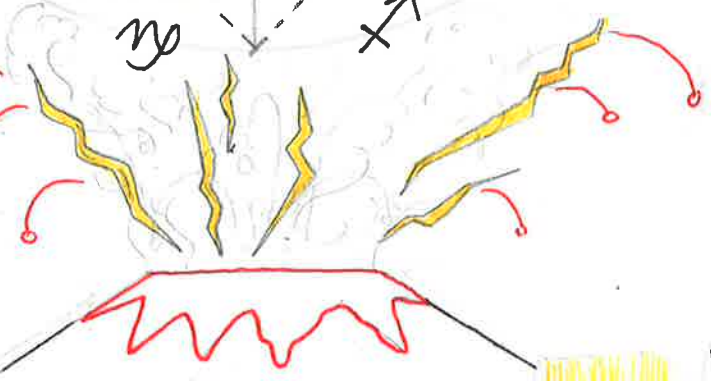
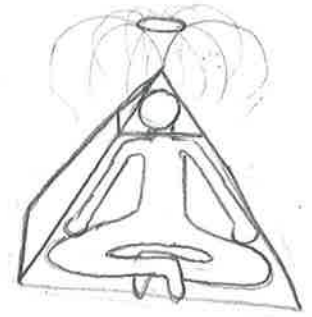
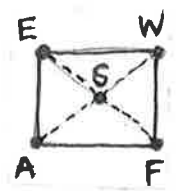
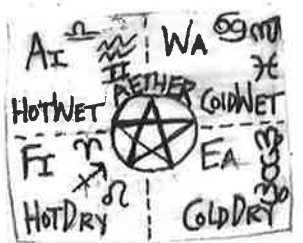
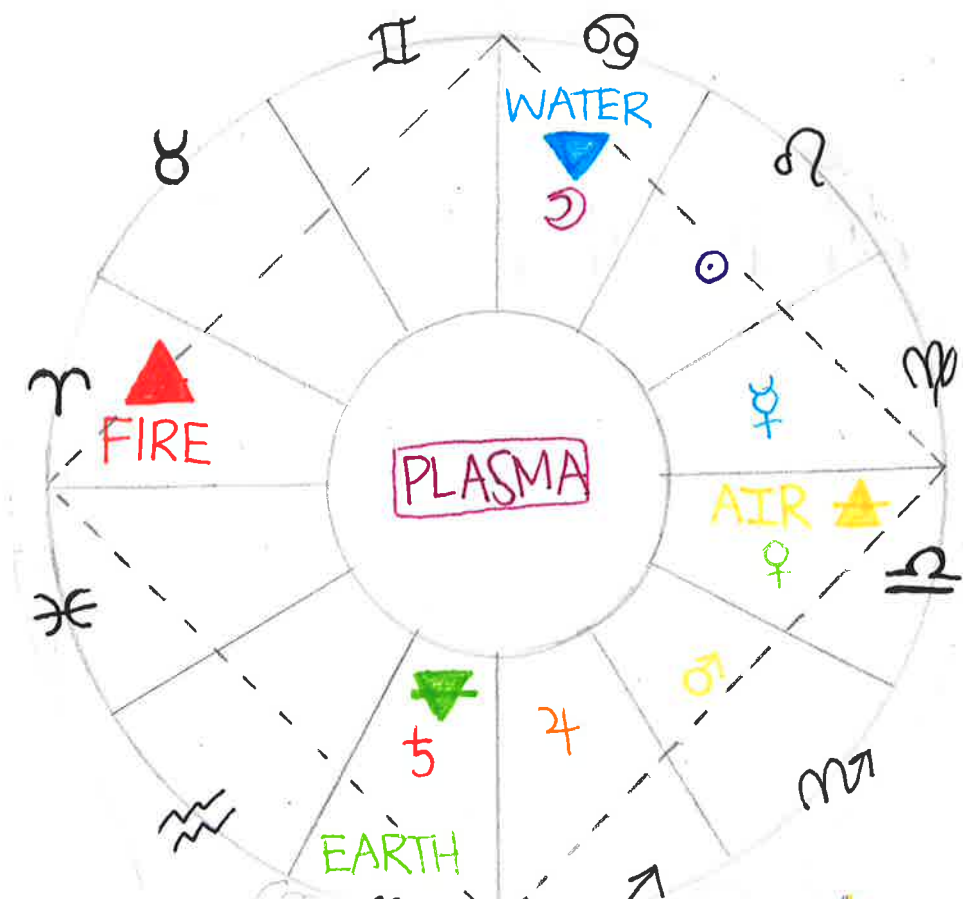

"PYRO-MID"  
"FIRE IN THE MIDDLE"

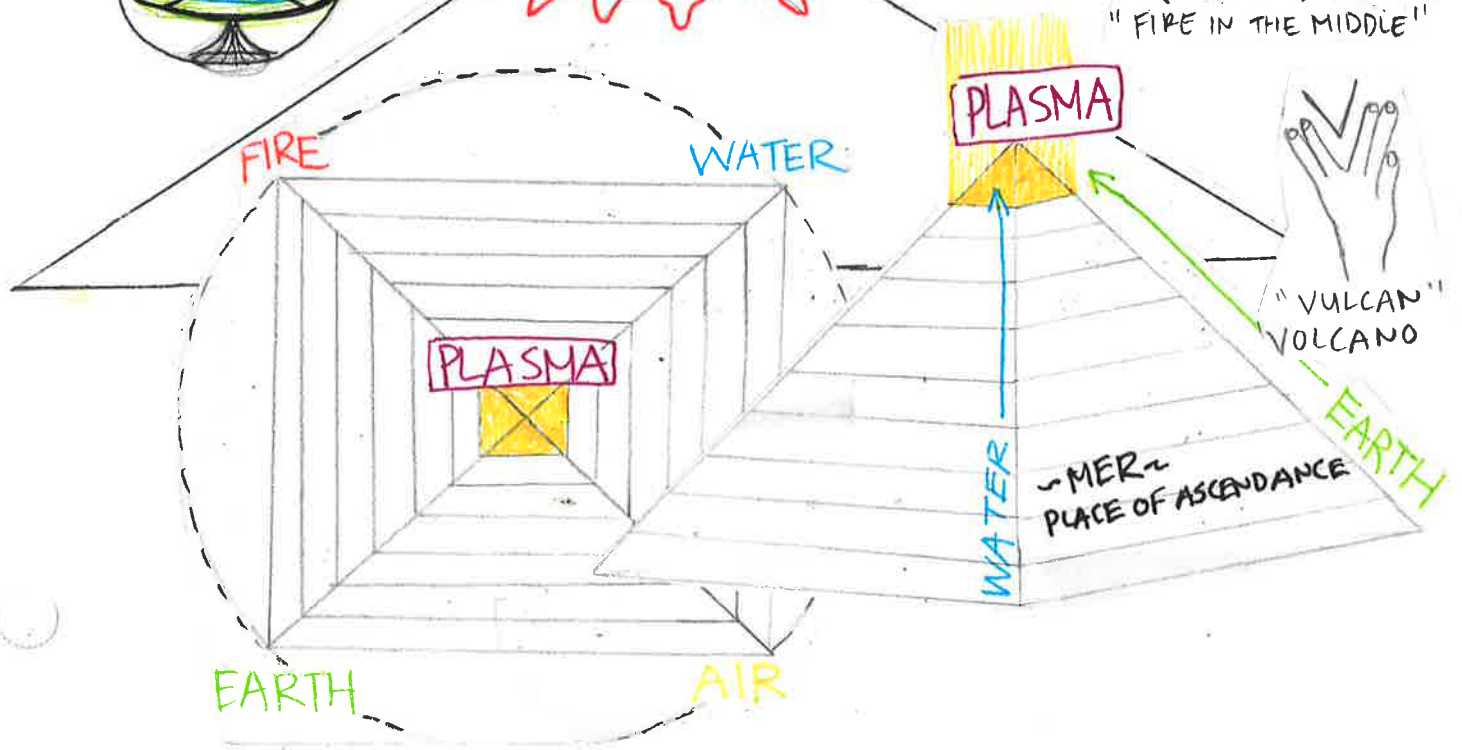



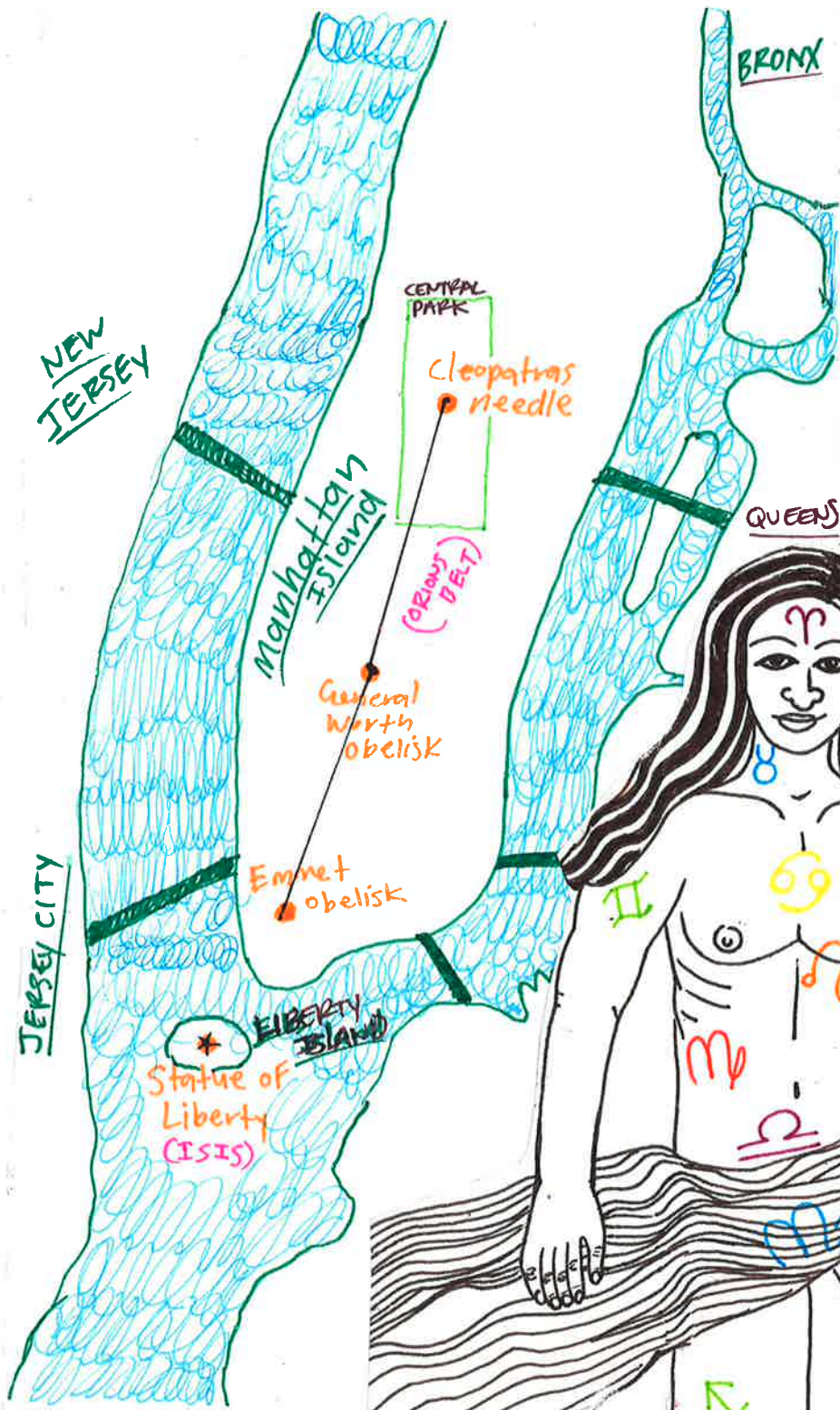

THE KABBALAH STATES BEFORE HUMANS THE ADAM KADMON (HEAVENLY HUMAN) OR ANDROGYNOUS COSMIC BEING WAS CREATED FIRST AS THE SPIRITUAL REFLECTION OF THE DIVINE CREATOR, ADAM AND EVE CREATED AS A PHYSICAL REFLECTION OF THE ADAM KADMON.

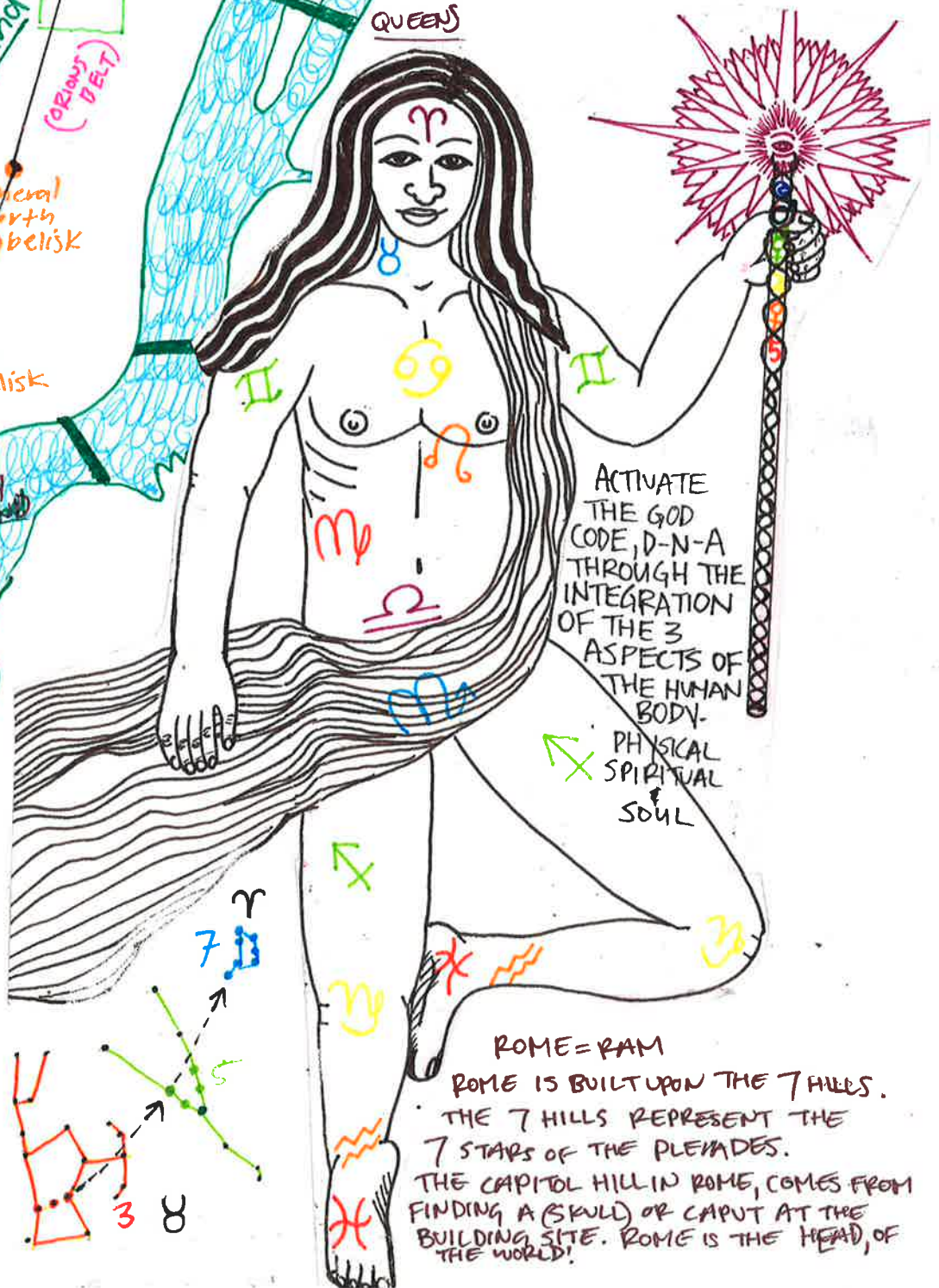

ACTIVATE THE GOD CODE, D-N-A THROUGH THE INTEGRATION OF THE 3 ASPECTS OF THE HUMAN BODY. PHYSICAL SPIRITUAL SOUL

ROME = RAM  
 ROME IS BUILT UPON THE 7 HILLS.  
 THE 7 HILLS REPRESENT THE 7 STARS OF THE PLEIADES.  
 THE CAPITOL HILL IN ROME, COMES FROM FINDING A (SKULL) OR CAPUT AT THE BUILDING SITE. ROME IS THE HEAD OF THE WORLD!

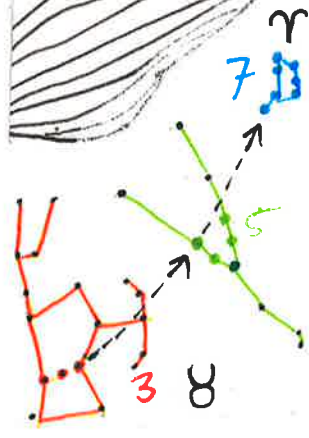



WARM  
(PRIMA-VERA)  
SPRING

12

HOT  
SUMMER

(TWINS)  
GEMINI

CANCER  
CRAB

ARIES  
(ARISE)  
ARES  
RAM

TAURUS  
BULL  
APRIL

LEO  
LION  
JULY

6  
PISCES  
FISH

VIRGO

6  
AQUARIUS  
MAN

SET-ENTA

LIBRA

(INVERNO)  
WINTER  
COLD

CAPRICORN  
GABRA  
SEA GOAT

SAGITTARIUS

FALL  
AUTUMN  
COOL

12

CSF flow

Central nervous system (CNS)

Ai	WA	EA
HOT WET	ETHER COLD WET	SPRIT COLD DRY
FI	MS	EA
HOT DRY	SPRIT	COLD DRY

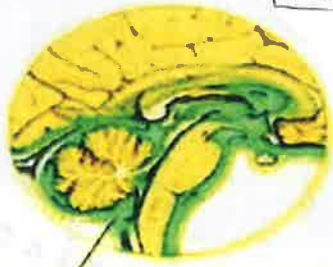

Cerebrospinal fluid (CSF)

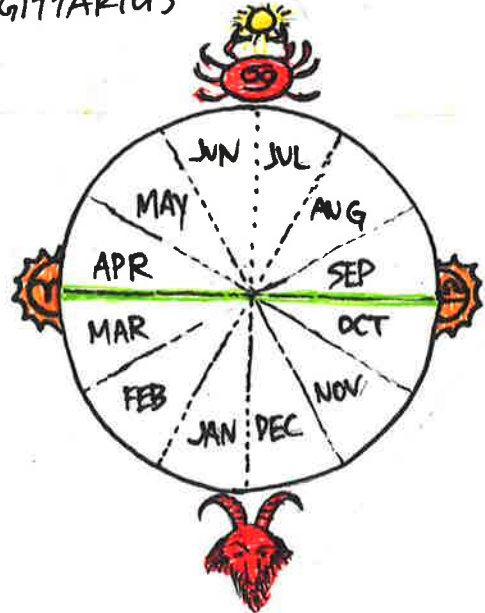



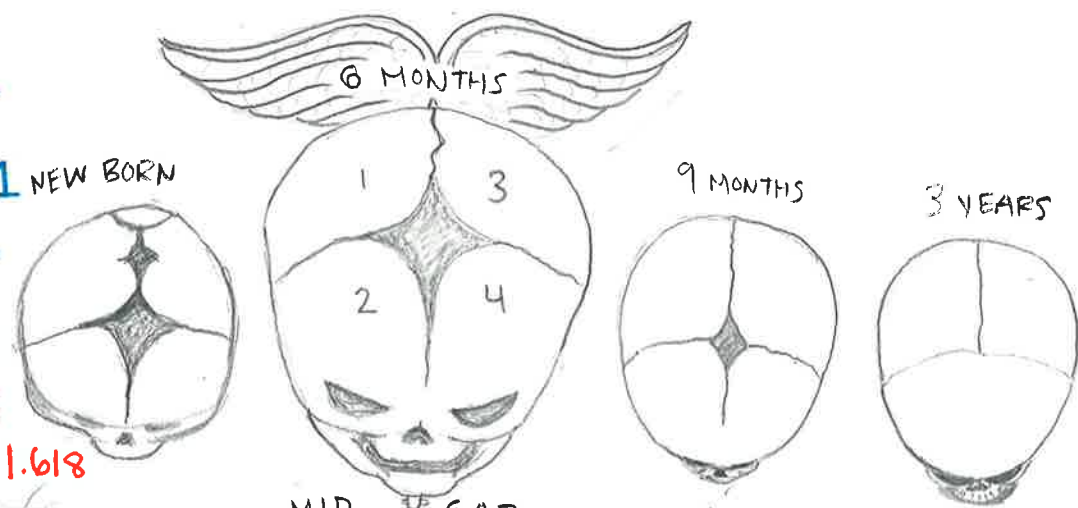
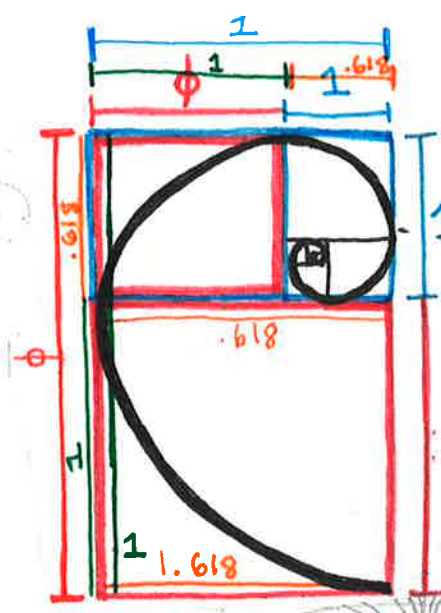

THE 12 BODY SYSTEMS

- 1 ENDOCANNABINOID
- 2 RESPIRATORY
- 3 CARDIOVASCULAR
- 4 REPRODUCTIVE
- 5 DIGESTIVE
- 6 ENDOCRINE
- 7 EXOCRINE
- 8 SENSORY/NERVOUS
- 9 RENAL
- 10 MUSCULAR
- 11 SKELETAL
- 12 LYMPHATIC/IMMUNE

THE 12 CRANIAL NERVES

- 1 OLFACTORY
- 2 OPTIC NERVE
- 3 OCULO MOTOR
- 4 TROCHLEAR
- 5 TRIGEMINAL
- 6 ABDUCEUS
- 7 FACIAL
- 8 VESTIBULOCOCHLEAR
- 9 GLOSSOPHARYNGEAL
- 10 VAGUS
- 11 ACCESSORY
- 12 HYPOGLOSSAL

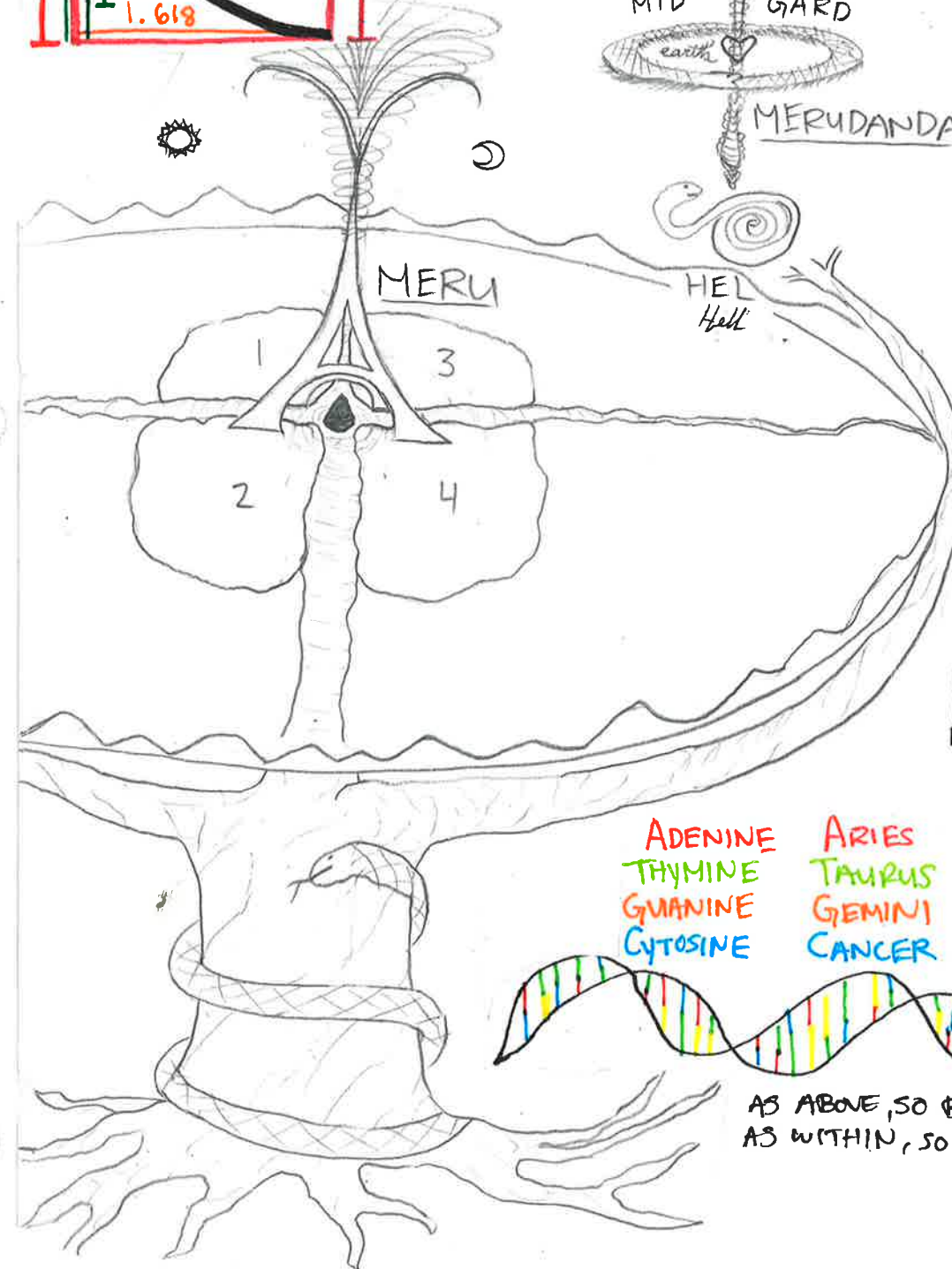

ADENINE  
 THYMINE  
 GUANINE  
 CYTOSINE

ARIES  
 TAURUS  
 GEMINI  
 CANCER

WE HAVE  
 46 CHROMOSOMES AND  
 64 NUCLEOTIDES/CODONS

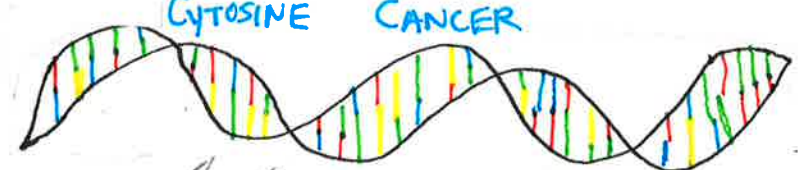

AS ABOVE, SO BELOW  
 AS WITHIN, SO WITHOUT



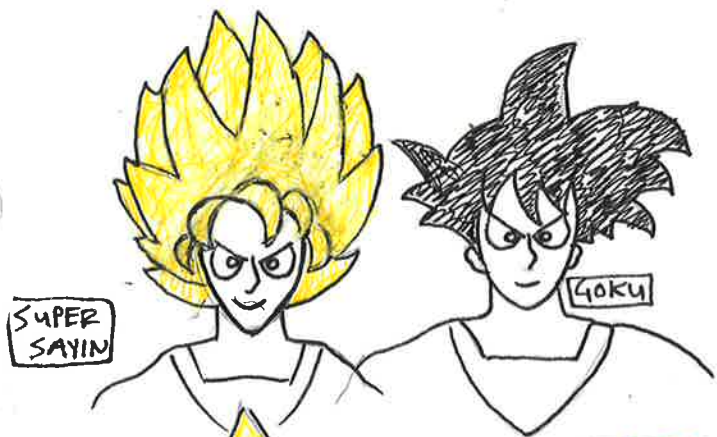

SUPER SAYIN

GOKU

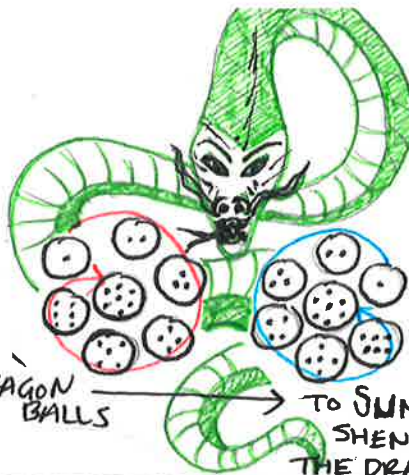

7 DRAGON BALLS

TO SUMMON SHENRON THE DRAGON

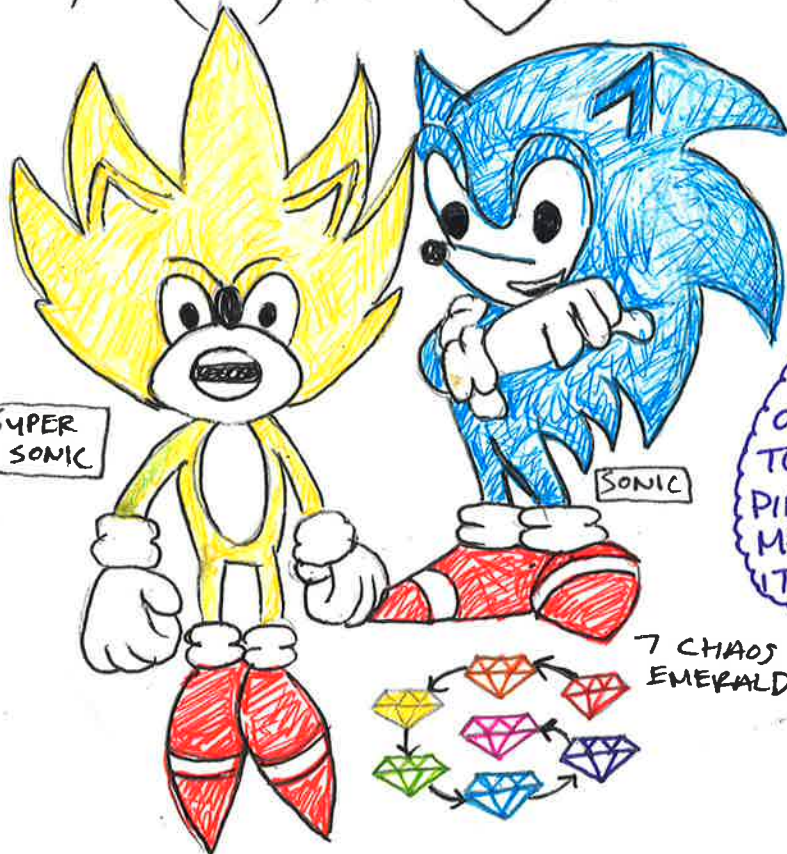

SUPER SONIC

SONIC

FROM SILVER TO GOLD

LUNAR CONSCIOUSNESS  
TO  
SOLAR CONSCIOUSNESS

THE CEREBRAL SPINAL FLUID IS SILVER IN THE NERVOUS SYSTEM & @ THE BASE OF THE SPINE, AND IT IS TURNED TO GOLD WHEN IT REACHES THE PINEAL GLAND, THE QUICKSILVER MERCURY RISES IN YOUR BODY AS IT WOULD IN A THERMOMETER.



7 CHAOS EMERALDS

E Time + F Space = V Form  
Kronos + Rhea = Jupiter  
Chronology + Area = Torus/Torso  
(COSMICRATORS)

BLACK LIGHT  
Dielectricity  
Rest  
Silence  
CHARGE  
CENTRIPETAL  
CONVERGENCE  
PURE POTENTIAL

WHITE LIGHT  
Magnetism  
Motion  
Torque  
DISCHARGE  
CENTRIFUGAL  
DIVERGENCE  
PURE IMPOTENCY

ELECTRICITY IS A HYBRID!

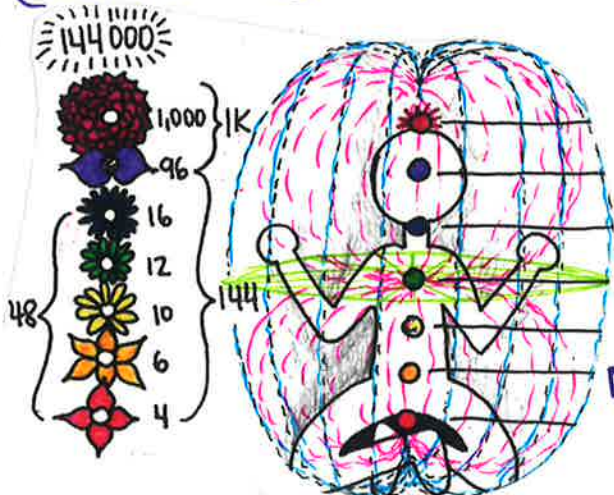

ZEUS - RED & BLUE LIGHT  
ILLUMINATION  
ELECTRIFICATION



(TRANSVERSE ELECTRO MAGNETIC)  
PURE ACTUALIZATION

SYNCHRONIZED ENERGY & HEMI-SYNC  
~ SYNERGY ~



EVERY CHAKRA IS A DIFFERENT COLOR DUE TO FREQUENCY - BUT THEY ALL COMBINE AS ONE.

EVERY HUMAN IS A DIFFERENT SHADE DUE TO DIVERSITY - BUT THEY ALL COMBINE AS SPIRITS IN A BODY.

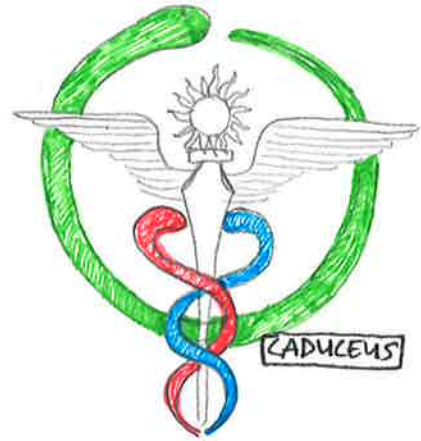
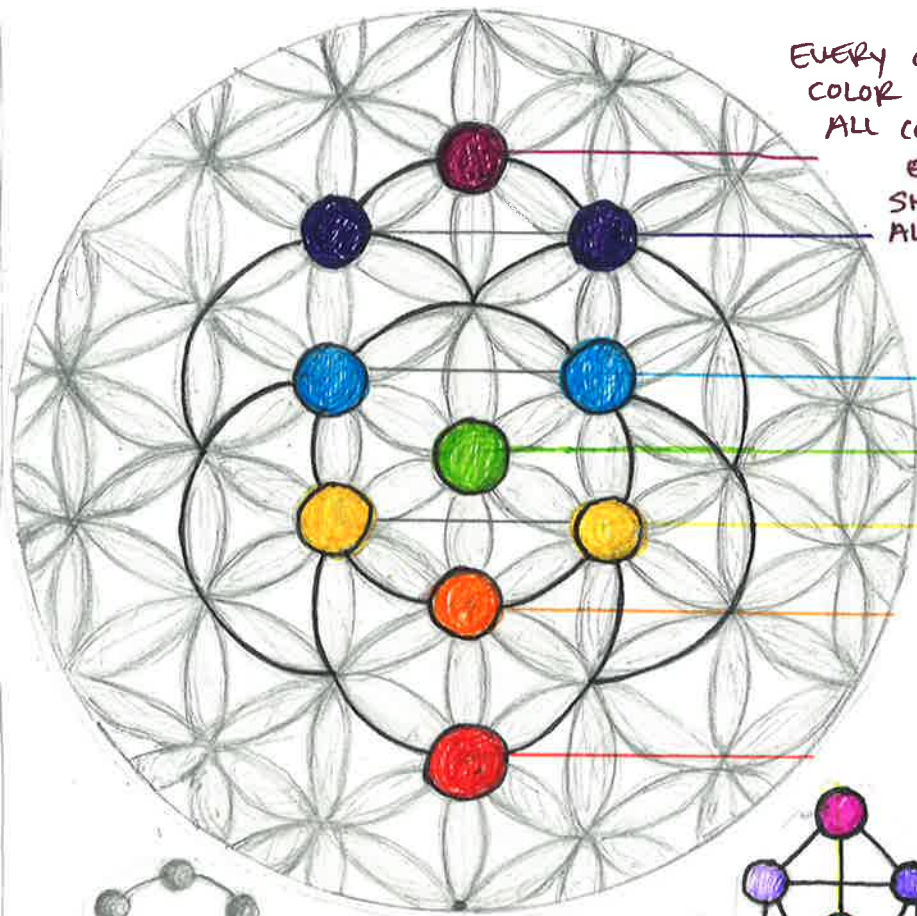

CADUCEUS



↑  
"THE FLOWER OF LIFE"

←  
"THE ANKH"



ASSYRIAN  
TREE OF LIFE



NORSE  
TREE OF LIFE

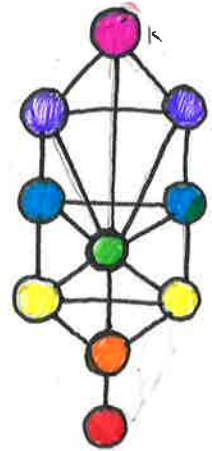

HEBREW  
TREE OF LIFE

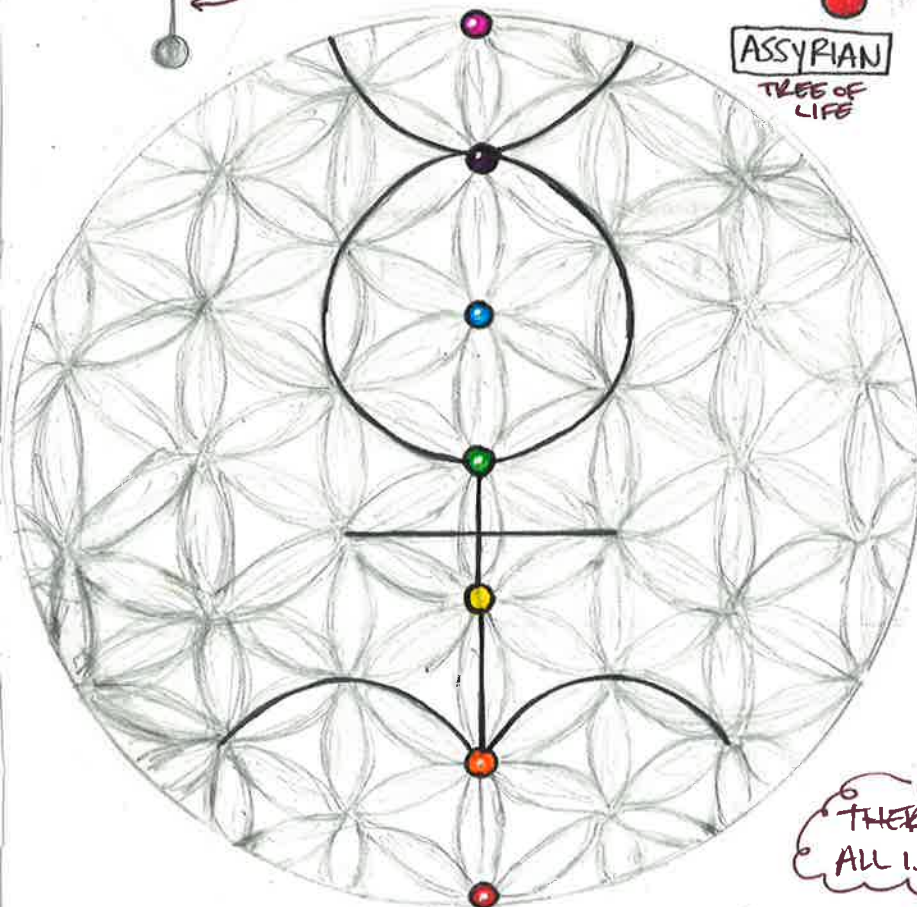

CAMELOT'S  
CASTLE

SOLOMONS  
TEMPLE

ANATOMY  
OF THE BODY

THERE IS ONLY ONE TRUTH, ALL IS ONE, AND ONE IS ALL! -DBDD



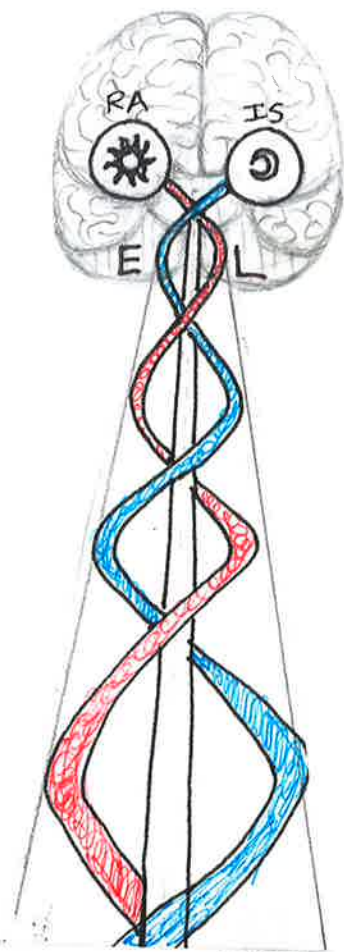
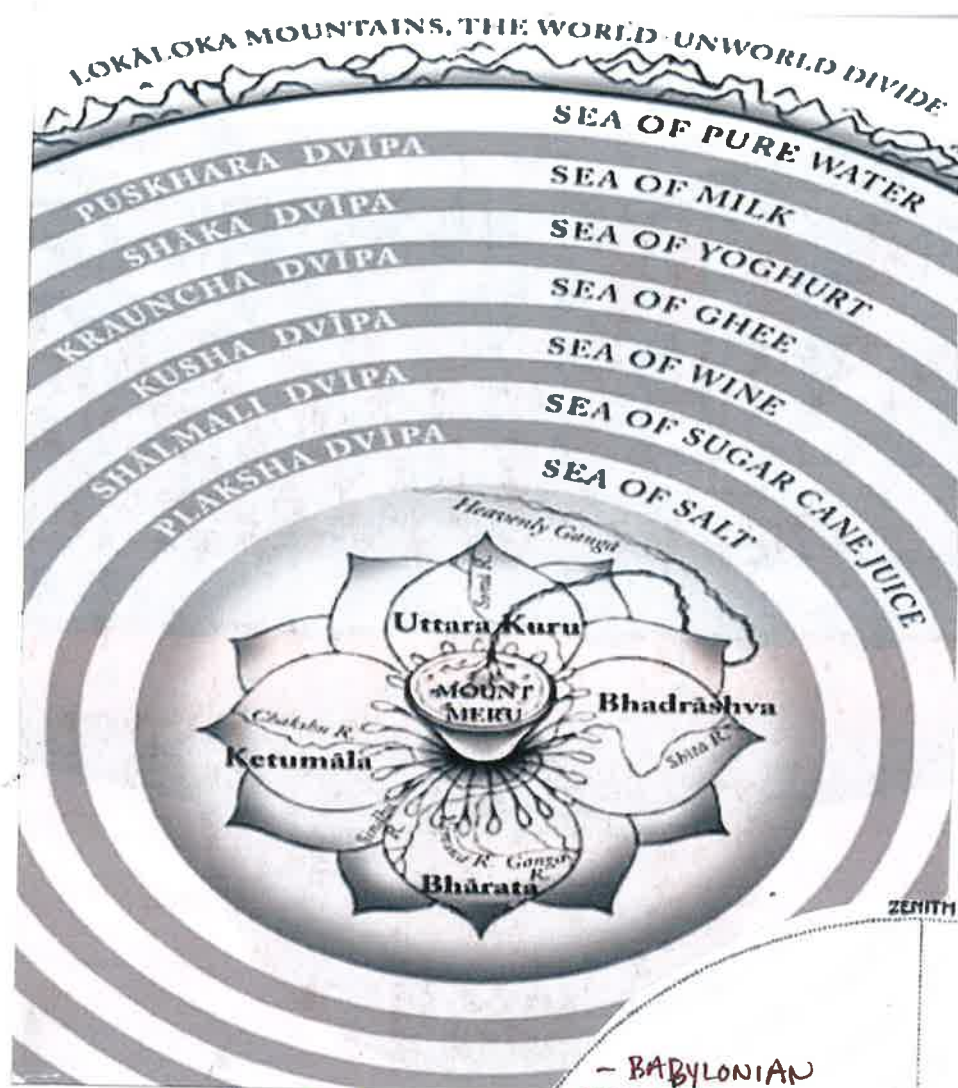

- BABYLONIAN COSMOLOGY

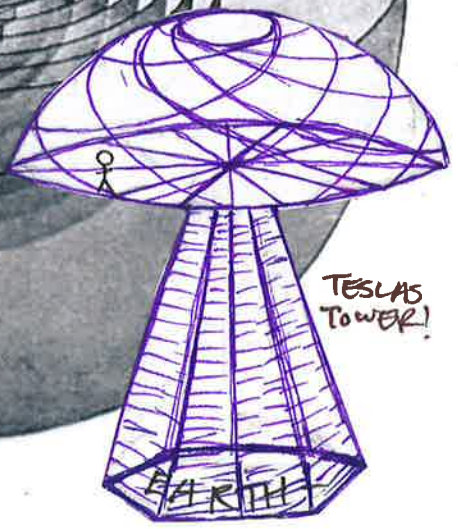
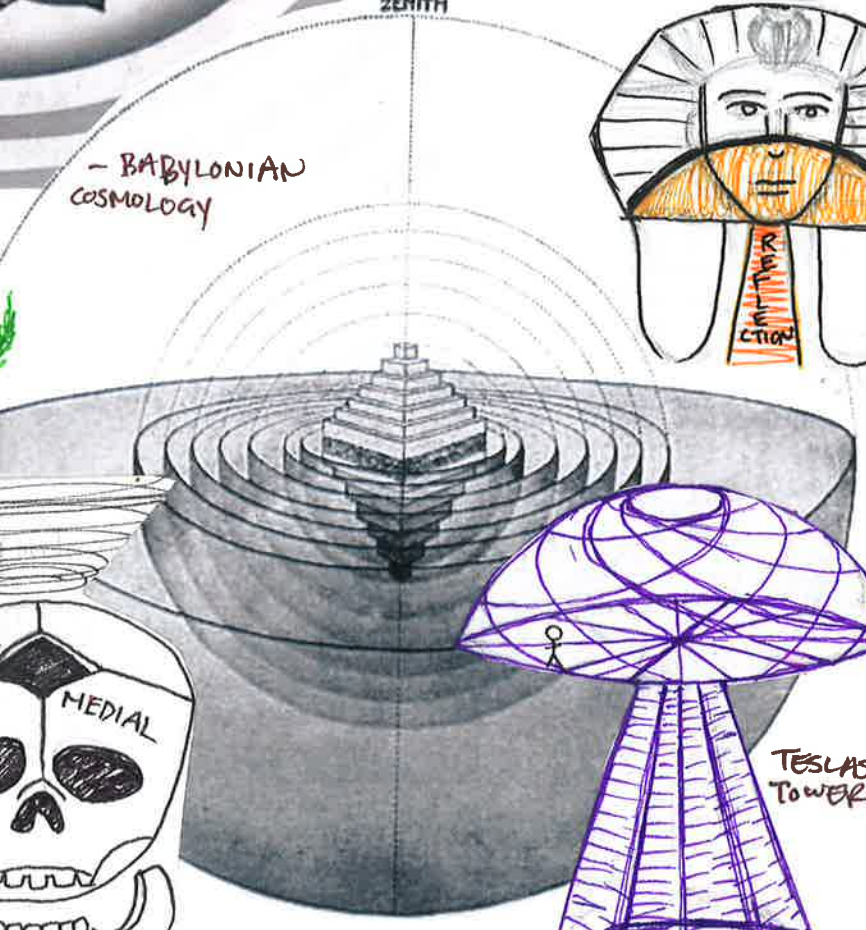
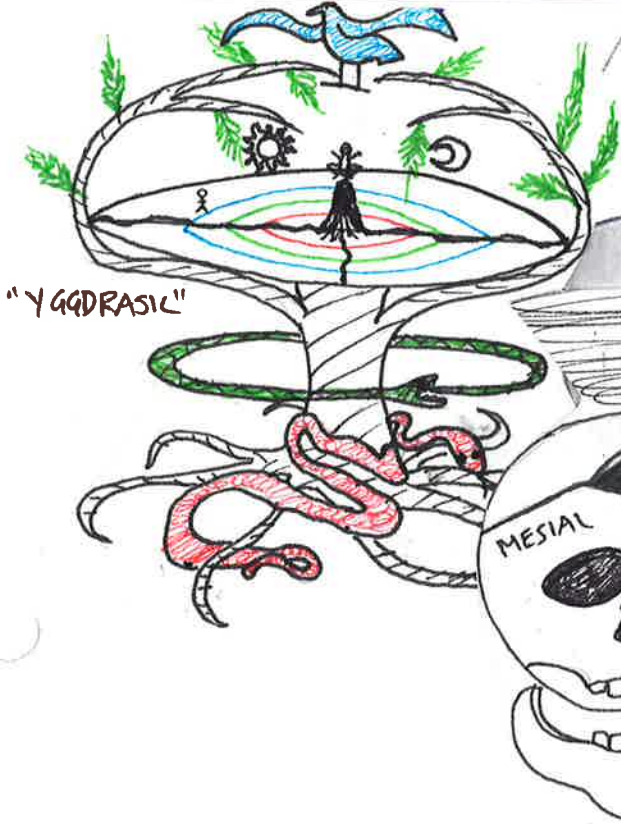



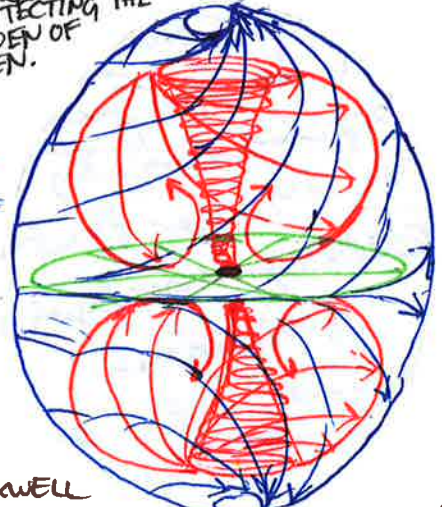
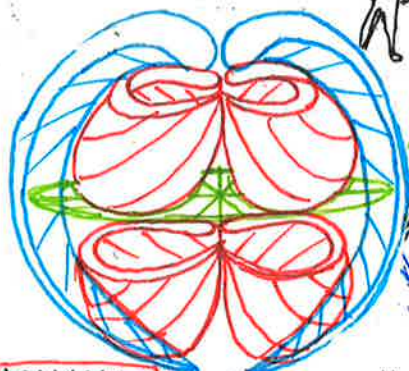
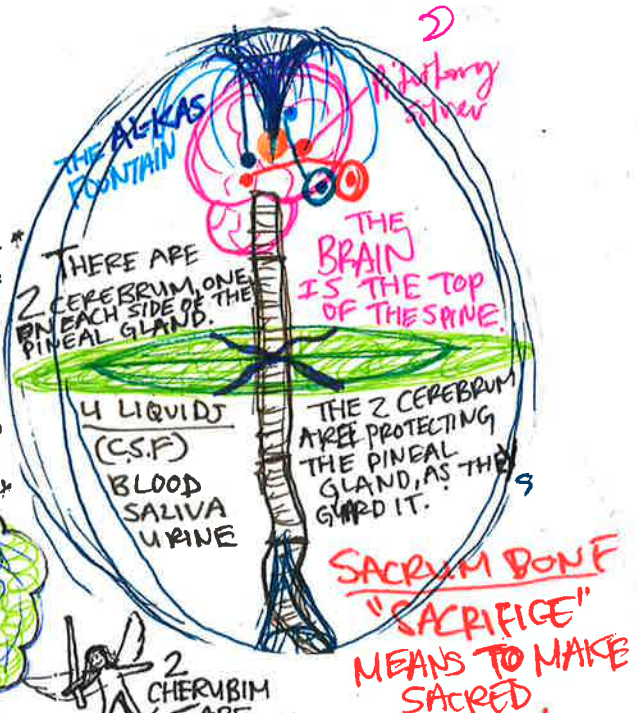
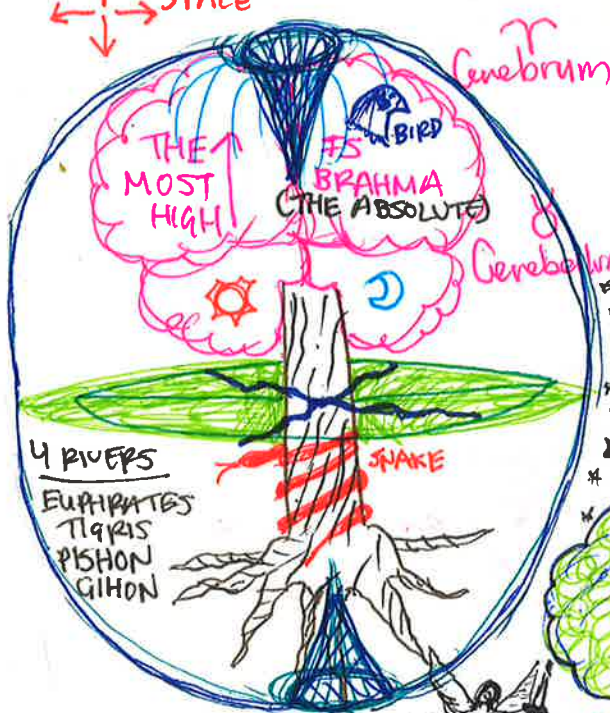
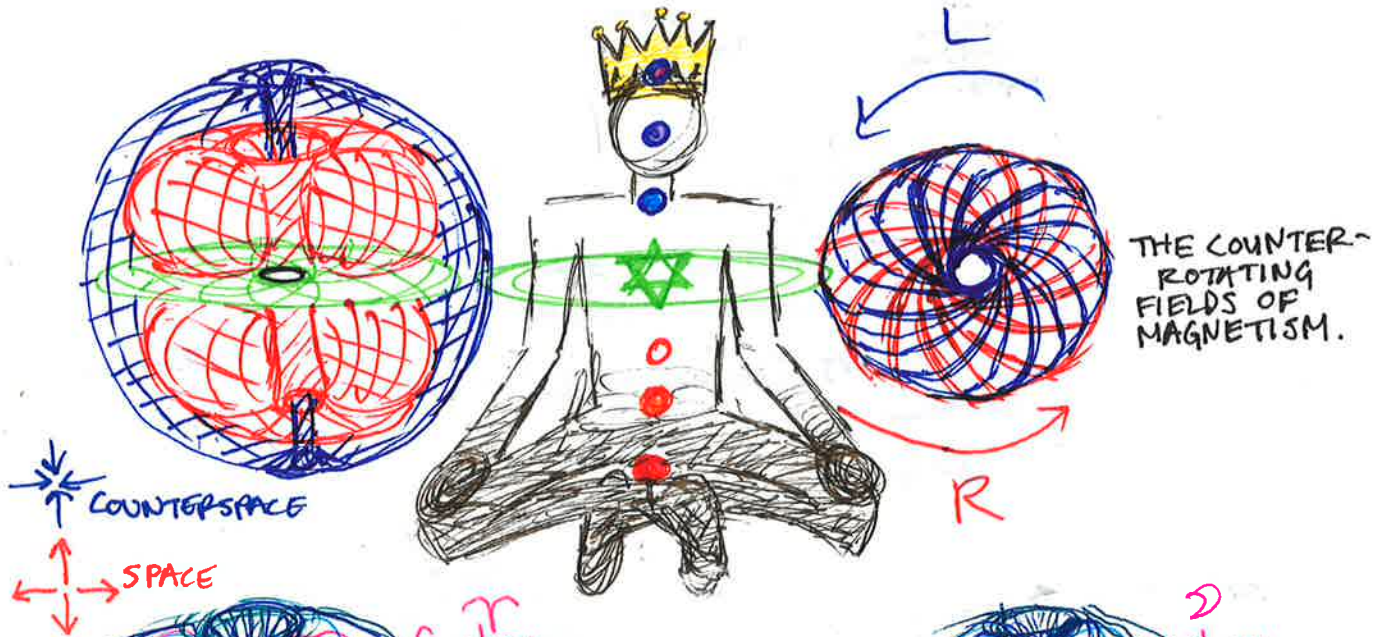

**ISAIAH 6:1** "In the year that King Uzziah Died, I saw the Lord, High and Exalted, Seated on a Throne, and The train of his Robe filled the Temple. Above him were **SERAPHIM**, Each with 6 wings: With 2 wings they Covered their faces, with 2 they Covered their feet, and with 2 they were flying."

- JORDAN MAXWELL  
 "THE BIBLE IS THE GREATEST STORY EVER TOLD!"  
 - BUT ITS JUST A STORY; WITH PURE ALLEGORY AND METAPHOR, FOR ANATOMY & ASTROLOGY.



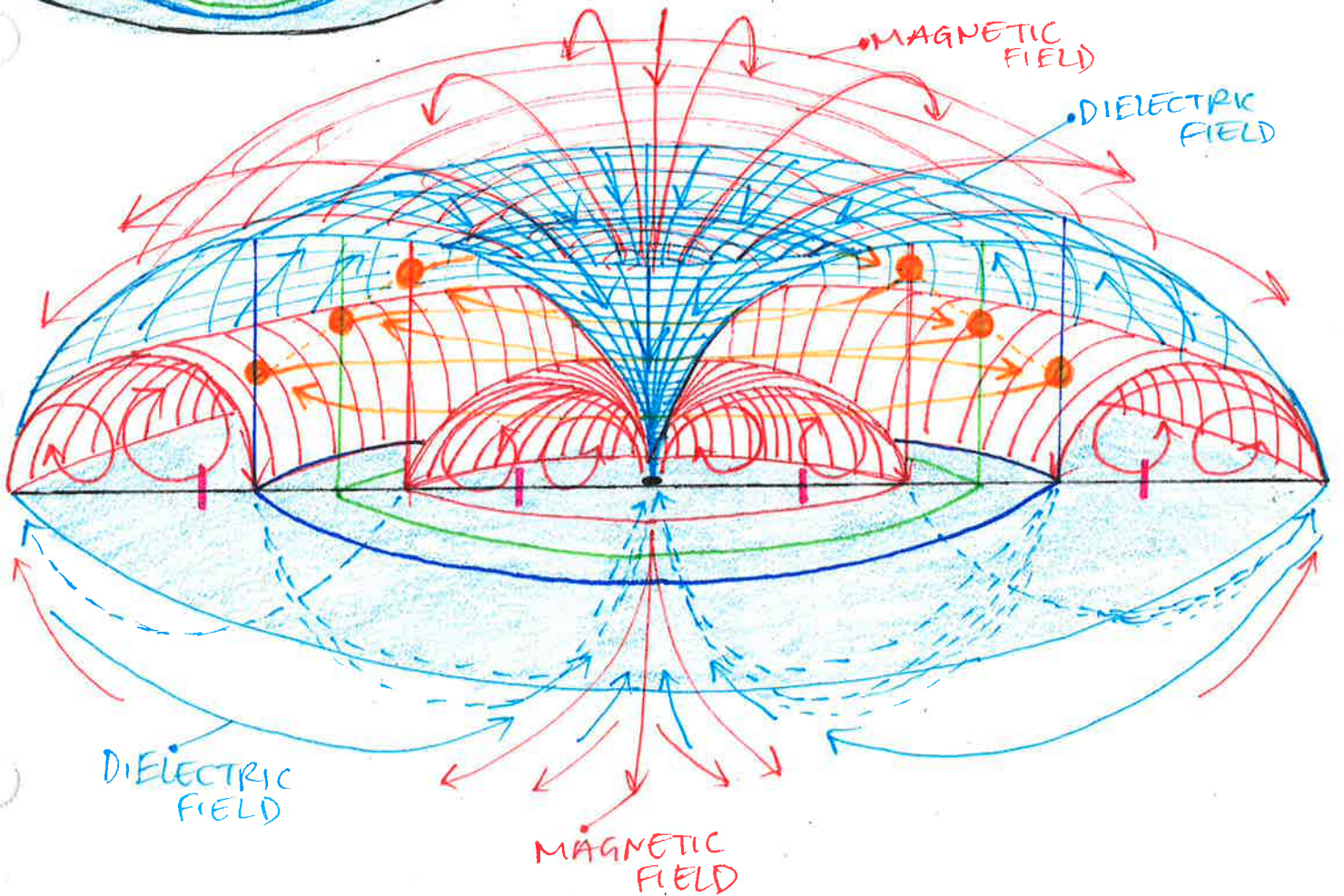
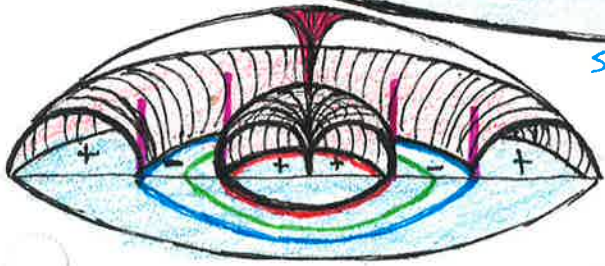
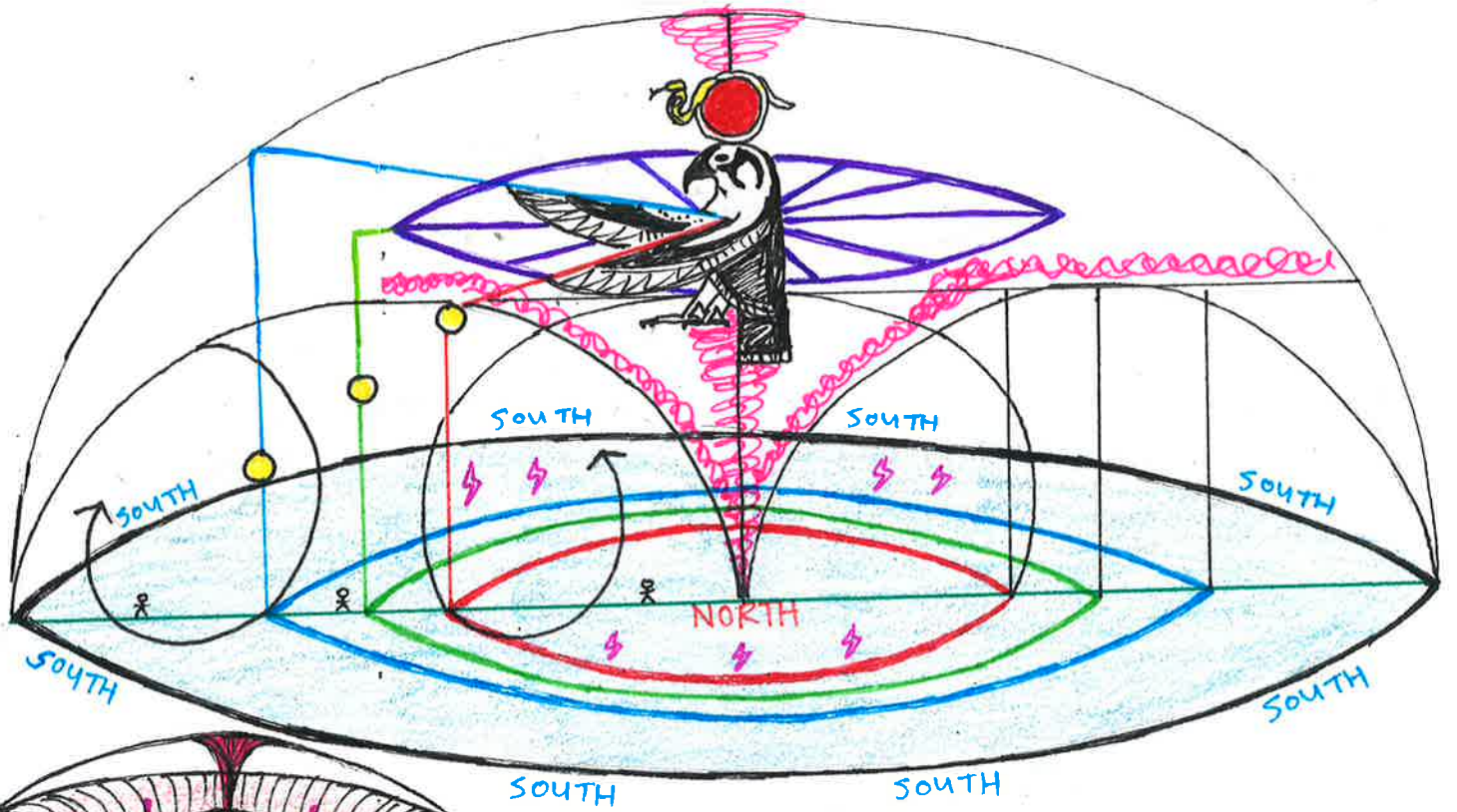



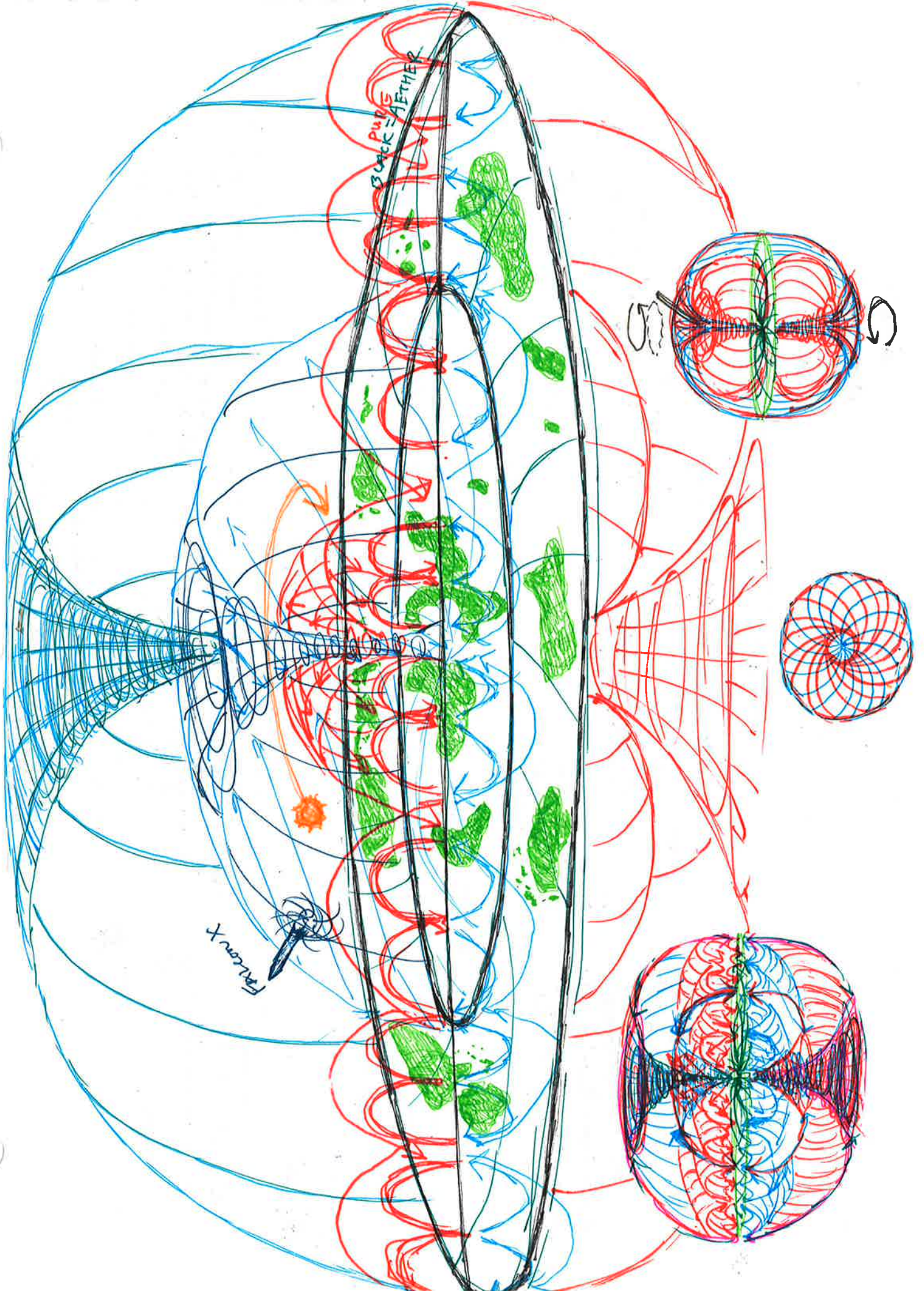



OS-IRIS  
OPEN-EYE

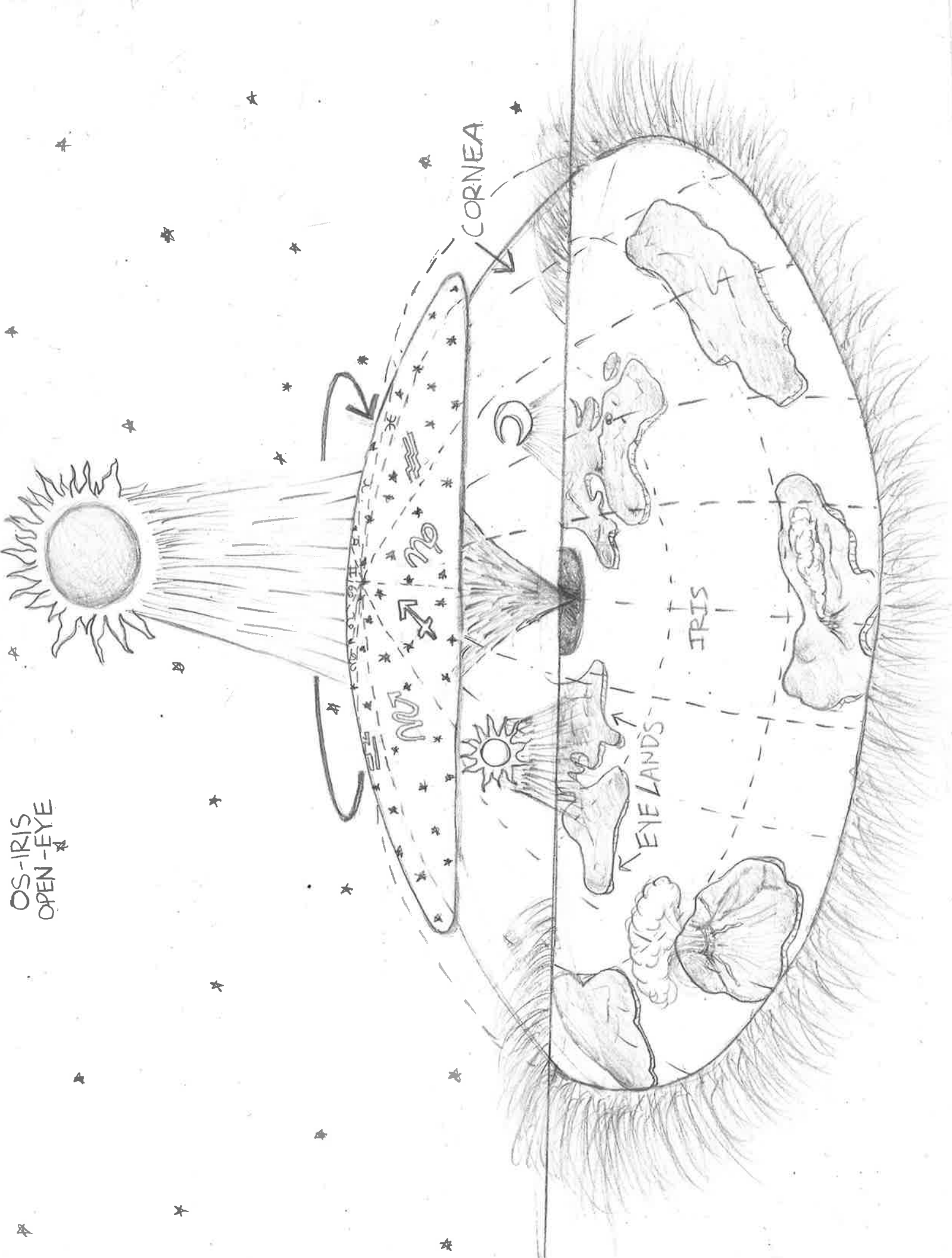

CORNEA

IRIS

EYE LANDS



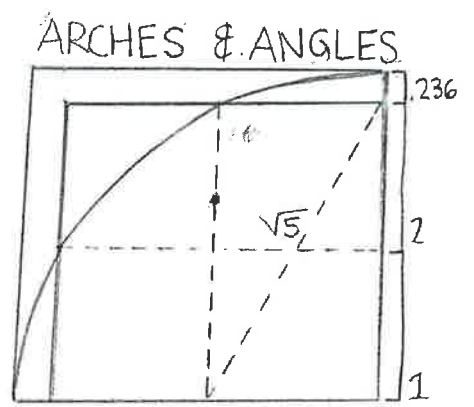
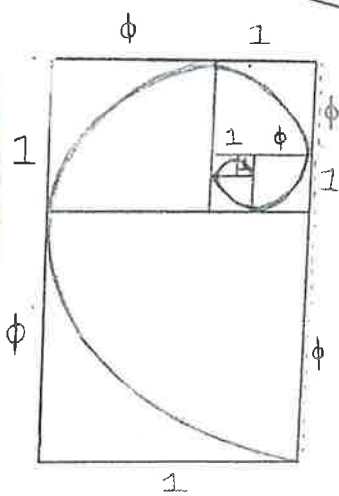
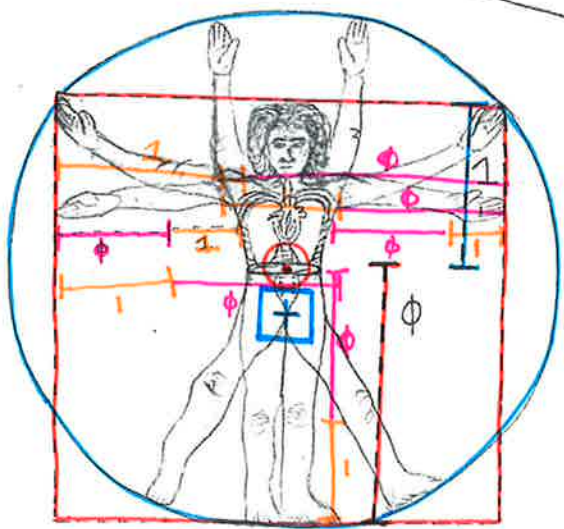
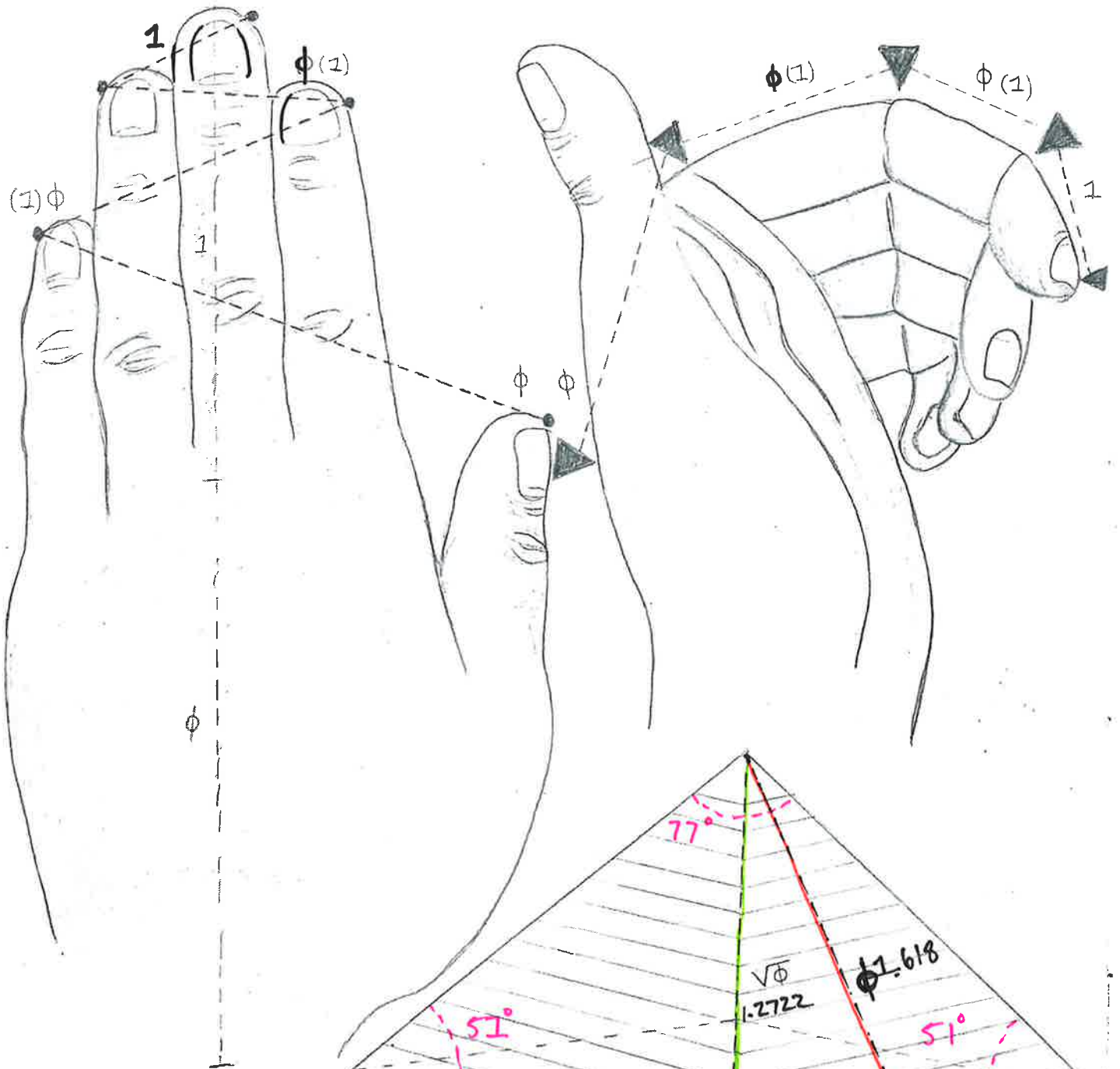



SEPHIROTH #1 REPRESENTS THE GOD HEAD OR GOD CONSCIOUSNESS.

SEPHIROTH #10 REPRESENTS US, OUR PHYSICAL EXISTENCE, THE PHYSICAL PLANE.

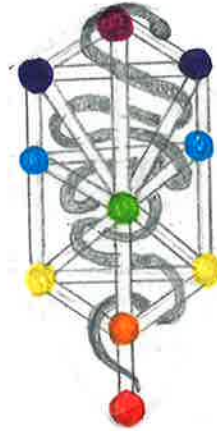
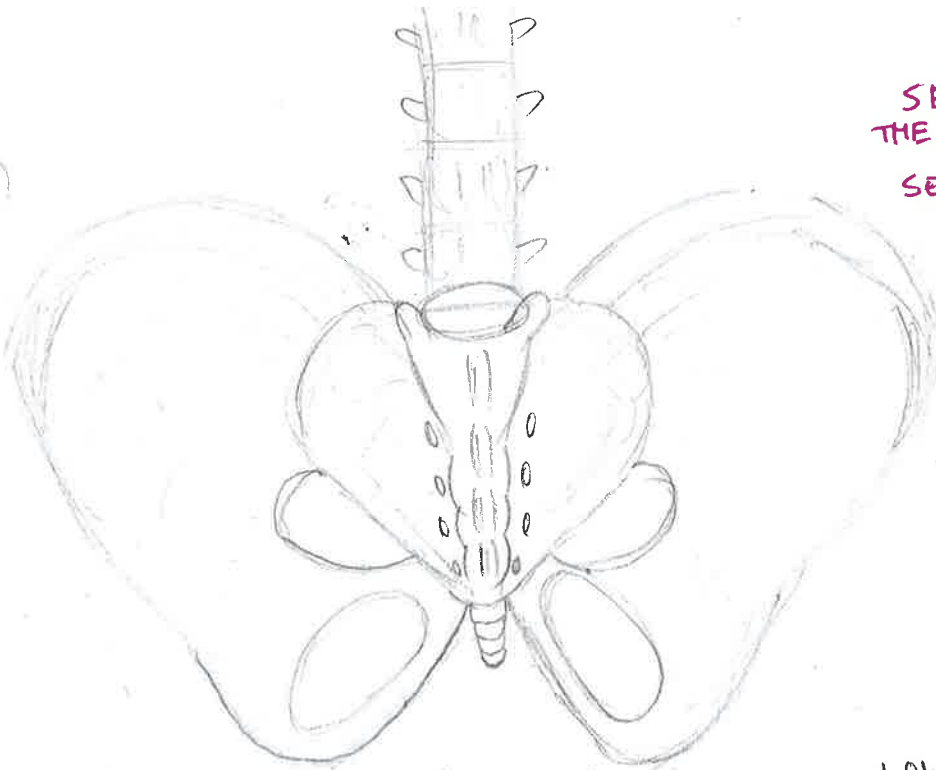

IF OUR CONSCIOUSNESS IS STUCK IN 10, WE ARE DISCONNECTED FROM GODS WISDOM, WE ARE DISCONNECTED FROM GOD-SELF.

FEAR



LOW FREQUENCY LONG SLOW WAVELENGTH ACTIVATES VERY FEW DNA CODING SITES.

THE SLAYING OF YALDABOATH IS THE OVERCOMING OF THE LOWER MIND.

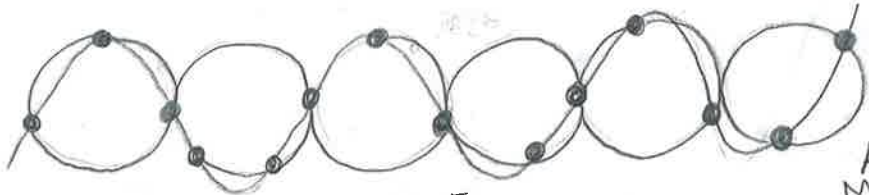

LOVE

HIGH FREQUENCY SHORT FAST WAVELENGTH ACTIVATES MANY MORE DNA CODING SITES.

LIKE DAVID AND GOLIATH.

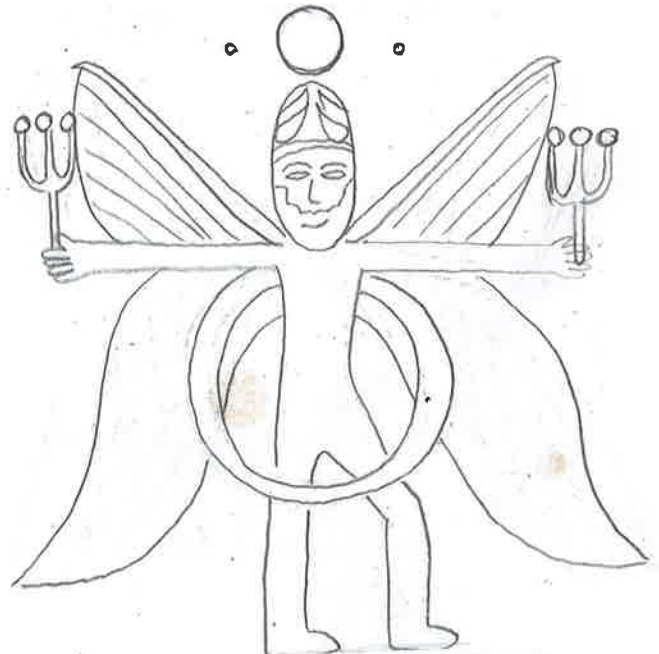
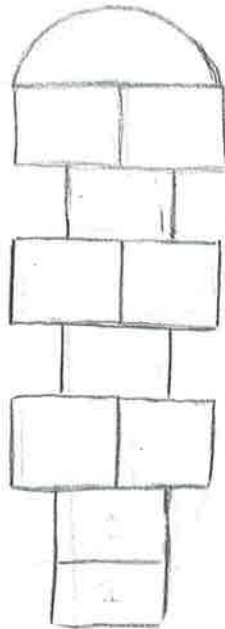
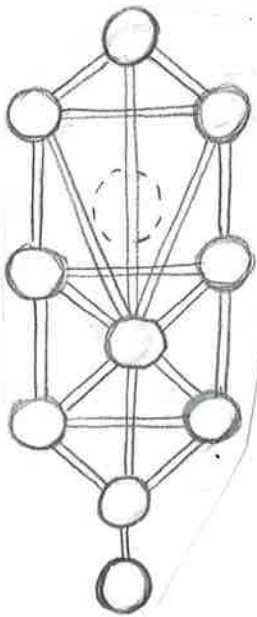

ODIN = ONE RUSSIAN

ANU ONE



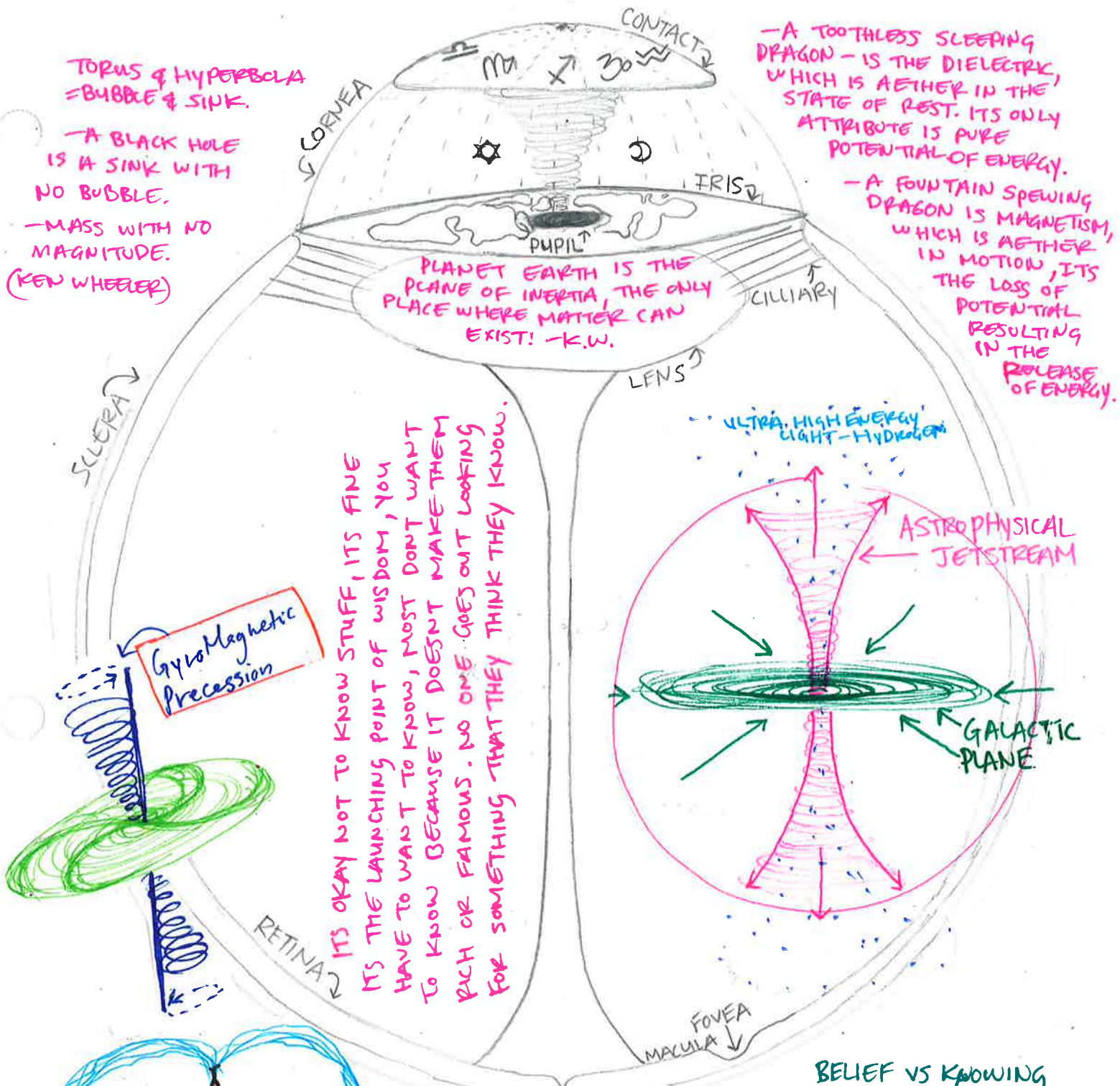

REV. 12:16 THE EARTH HELPED THE WOMAN AND THE EARTH OPENED UP ITS MOUTH AND SWALLOWED THE RIVER WHICH THE DRAGON SREW OUT OF ITS MOUTH.

← FROM A TO B, THERE IS SPACE. - RANGE.

**BELIEF VS KNOWING**

- EARTH'S SUPPOSED ROTATION - MACH 1.348 = 1,035 MPH = .445 KMPH
- EARTH'S SUPPOSED REVOLUTION - MACH 70-88 = 66,600 MPH = 30 KMPH
- SUN'S SUPPOSED REVOLUTION - MACH 716 = 550,000 MPH = 200 KMPH
- MILKY WAY'S REVOLUTION SUPPOSEDLY - MACH 847,160 = 650,000,000 MPH = 290,000 KMPH

Made possible by NASA



EL  
⚔

AETHER

Archetypal world  
ATZILUTH: DIVINE EMANATION

Spiritual World  
BRIAH: CREATION

psychological world  
YETZIRAH: FORMATION

physical world  
ASSIAH: ACTION

EARTH

THESSALONIANS 5:23 "MAY THE PEACE OF GOD SANCTIFY YOU WHOLLY, AND MAY YOUR SPIRIT, SOUL AND BODY BE KEPT SOUND."

"THE HEART IS THE LOCATION OF THE HUMAN SOUL AND LIFE FORCE." - IN ESSENCE

PEACE | Happiness  
INTELLIGENCE | Fulfillment  
LOVE | Harmony

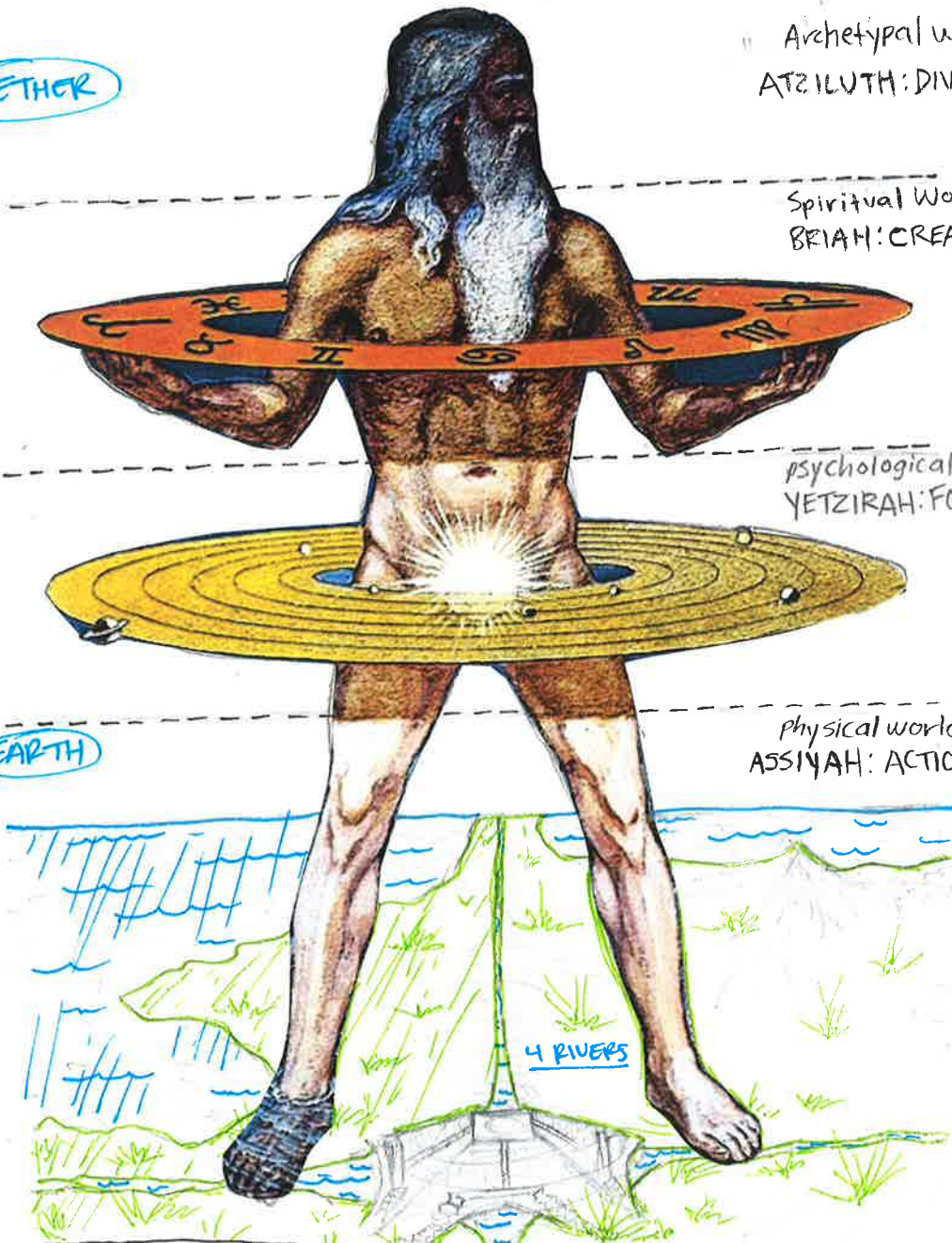

4 RIVERS

TIME IN EACH ZODIAC

☉ 2-3 Days	☉ 27-30 Days
♀ 25 Days	♀ 88 Days
♀ 28 Days	♀ 225 Days
♁ 1 Month	♁ 365 Days
♁ 2 Months	♁ 720 Days
♃ 1 year	♃ 12 years
♄ 2-3 years	♄ 27-30 years

FULL CYCLE IN EACH ZODIAC

♁ 7 years	♁ 84 years
♀ 14 years	♀ 168 years
♀ 11-30 years	♀ 248 years

<b>BODY</b>	<b>SPIRIT</b>	<b>SOUL</b>
SIGHT	AWARENESS	WILL
HEAR	SENSITIVITY	EMOTION
TASTE	UNDERSTANDING	<del>ESSENCE</del>
TOUCH	MOTIVATION	ESSENCE
SMELL	<b>SPIRITUAL</b>	<b>PSYCHOLOGICAL</b>
<b>PHYSIOLOGICAL</b>	EXTRA-TERRESTRIAL	CELESTIAL
TERRESTRIAL		



@BROSANCHEZTV  
YOUTUBE:

YOUTUBE: JESSE JOHNSON & FLATEARTH PHILOSOPHY

WAY THE SUN IS SMALLER THAN WHAT IS THEORIZED. AND SHINES IN ALL DIRECTIONS.

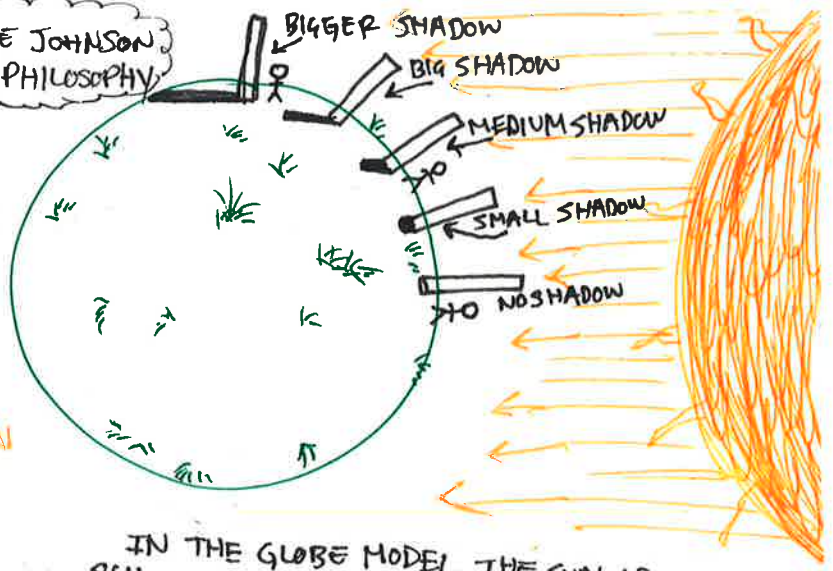
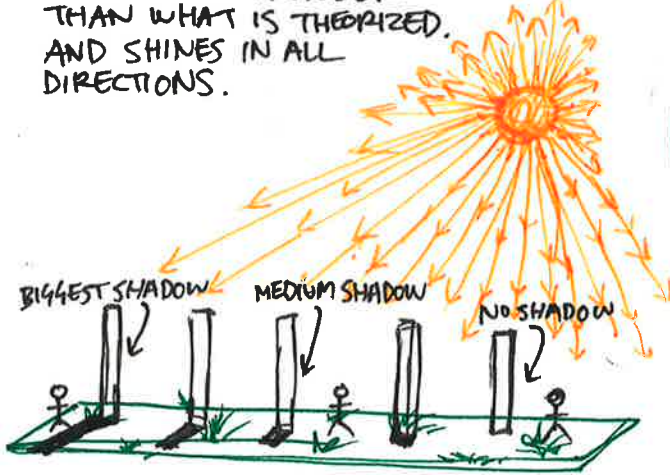

IN THE GLOBE MODEL, THE SUN IS 864,000 MILES IN DIAMETER AND 93 MILLION MILES AWAY; CAUSING LIGHT TO SHINE IN ONLY ONE DIRECTION WHICH IS OBSERVABLY INACCURATE.

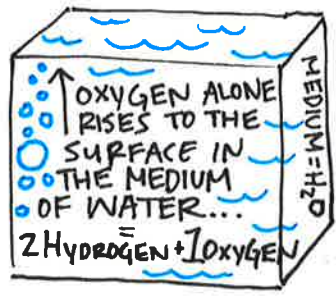

**LIGHT**  
 $H^1 = 1$  PROTON | Electron VS. 1.00794 U  
 $O^8 = 8$  PROTONS & 8 NEUTRONS HEAVY 15.999 U  
 $H^2O = 18.015$

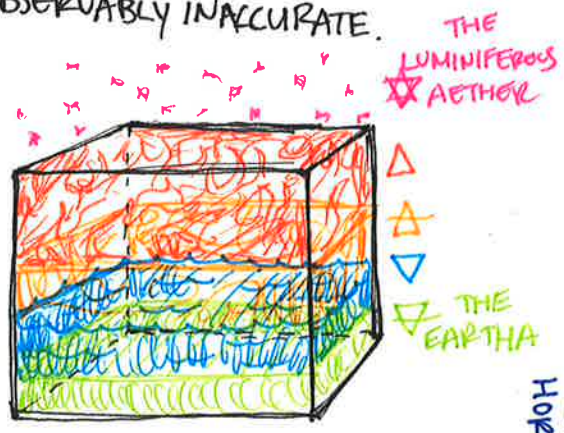
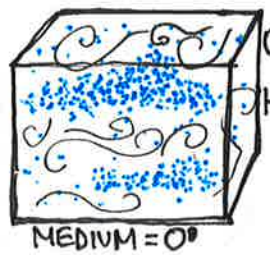

RAIN FALLS, WHEN HYDROGEN COMBINES AND BECOMES HEAVY.

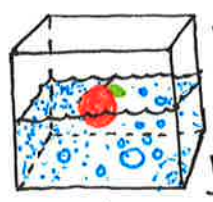

WHY DOES AN APPLE FLOAT IN WATER? WHAT HAPPENED TO GRAVITY?

THE WEIGHT OF THE WATER IS MORE THAN THE WEIGHT OF THE APPLE... THE WATER RUSHES TO THE BOTTOM & THE APPLE MUST FIND ITS DENSITY LEVEL, UNDER THE AIR, ABOVE THE WATER'S SURFACE.

"WHEN WE INCREASE OUR ALTITUDE, THE HORIZON LINE WILL FOREVER REMAIN @ EYE LEVEL... PROVING THAT THE EARTH MUST BE WAY BIGGER THAN WHATS COMMONLY THEORIZED, OR ITS AN INFINITE PLANE IN ALL DIRECTIONS!"  
 -DAVID WEISS



THIS IS NOT AN ILLUSION OR A MIRAGE, THE CHICAGO SKYLINE SHOULD BE 700-900 FT BELOW SEA LEVEL | EARTH'S CURVATURE!

THE SUZ CANAL IS 120 MILES OF FLAT RIVER, IT CONNECTS THE MEDITERRANIAN & INDIAN OCEANS, WHICH IS 15,000 MILES OF FLAT SURFACE OF THE WATER, AROUND AFRICA.

THE BOLIVIAN SALT LAKE IS LIKE MILES OF FLATNESS IN ALL DIRECTIONS.

-SANTOS B

GYROSCOPES IN AIRPLANES ARE USED AS ARTIFICIAL HORIZONS - PROVING FLAT EARTH!



THE TOKAMAK WE DON'T NEED TOKAMAKS! ~~Ø~~  
 IS A RUSSIAN ACRONYM  
 FOR (TOROIDAL-CHAMBER-MAGNETIC-COILS)

THE TOKAMAK IS TODAY'S MOST ADVANCED EXPERIMENTAL MACHINE AND BEST INVESTIGATED FUSION DEVICE DESIGN THAT HAS THE ABILITY TO RECREATE THE CONDITIONS WITHIN A STAR WITH A UNIQUE MISSION PRODUCING THE TREMENDOUS TEMPERATURE AND PRESSURE CONDITIONS NEEDED FOR NUCLEAR FUSION TO TAKE PLACE.

INVENTED IN THE SOVIET UNION DURING THE 1960'S AND SOON ADOPTED BY RESEARCHERS AROUND THE WORLD.

THE (JOINT-EUROPEAN-TORUS) J.E.T. LOCATED @ CULHAM SCIENCE CENTRE FOR FUSION ENERGY IN OXFORD UNITED KINGDOM, IS THE LONGEST AND MOST POWERFUL TOKAMAK CURRENTLY OPERATING. IT IS A DOUGHNUT SHAPED VESSEL SURROUNDED BY MAGNETS. DEUTERIUM AND TRITIUM FUEL INSIDE THE TOKAMAK ARE HEATED TO 150 MILLION DEGREES FAHRENHEIT, 10 TIMES X HOTTER THAN THE SUN'S CORE. THESE EXTREME

TEMPERATURES CAUSE THE FUELS ATOMS TO SEPERATE INTO IONS AND ELECTRONS, FORMING A CLOUD OF CHARGED PARTICLES KNOWN AS PLASMA. TO MAINTAIN THE FUELS TEMPERATURE, IT CANNOT BE ALLOWED TO TOUCH THE COOLER WALLS OF THE TOKAMAK, BESIDES AT THIS TEMPERATURE, THE PLASMA WOULD SIMPLY MELT THROUGH ANY SOLID MATERIAL KNOWN TO MAN. INSTEAD, TWO SETS OF MAGNETS, CREATE AN INVISIBLE CAGE, CONFINING THE FUEL AND SUSPENDING IT SAFELY AWAY FROM THE TOKAMAK WALLS.

- INSIDE, J.E.T. IS COVERED IN PROTECTIVE METAL TILES, AND VARIOUS DIAGNOSTICS FOR MEASURING WHATS GOING ON.



- ① J.E.T - LOCATED IN ENGLAND, UNITED KINGDOM. (JOINT EUROPEAN TORUS) JET PRODUCES = 16 MEGAWATTS
- ② I.T.E.R - LOCATED IN SOUTHERN FRANCE. (INTERNATIONAL THERMONUCLEAR EXPERIMENTAL REACTOR) ITER PRODUCES = 500 MEGAWATTS
- ③ E.A.S.T - LOCATED IN HEIJI CHINA. (EXPERIMENTAL ADVANCED SUPERCONDUCTING TOKAMAK) EAST PRODUCES = 7.5 MEGAWATTS
- ④ K.S.T.A.R - (KOREA SUPERCONDUCTING TOKAMAK ADVANCED RESEARCH) IN SOUTH KOREA
- ⑤ DEMO - IS A TOKAMAK BEING CONSTRUCTED AND WILL BE THE BIGGEST IN THE WORLD; PRODUCING 2000-4000 MEGAWATTS. KSTAR PRODUCES = 14 MEGAWATTS

THERMO-NUCLEAR FUSION REACTORS

"ITER" IS LATIN FOR "THE WAY" AS IN (THE WAY TO FREE ENERGY). I.T.E.R COLLABORATES WITH RUSSIA, CHINA, INDIA, USA, EUROPE, JAPAN, SOUTH KOREA AND OTHER NATIONS.

"CARBON FREE" - MAGNETIC FUSION BASED ELECTRICITY. "AS LONG AS THE OCEAN HAS WATER, FUEL IS INFINITE." ~ FREE ENERGY ~



NORTHERN/LOWER EGYPT, IN THE GEOGRAPHICAL CENTRE OF THE LAND SURFACE OF THE WHOLE WORLD.

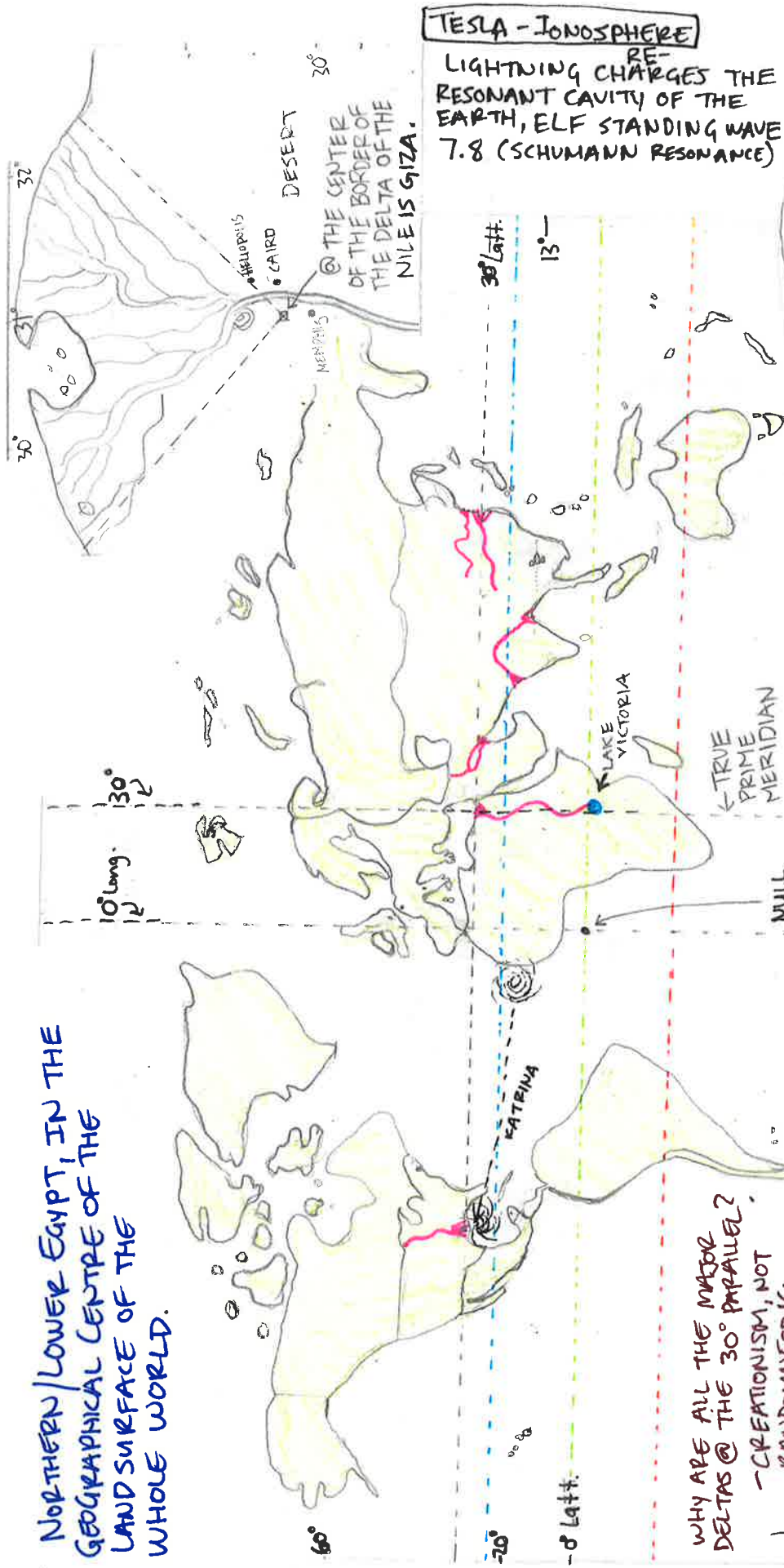

**TESLA - IONOSPHERE**  
 LIGHTNING CHARGES THE RESONANT CAVITY OF THE EARTH, ELF STANDING WAVE 7.8 (SCHUMANN RESONANCE)

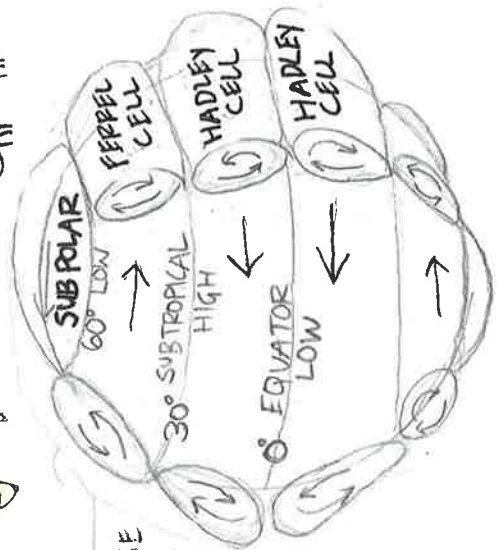

WHY ARE ALL THE MAJOR DELTAS @ THE 30° PARALLEL?  
 - CREATIONISM, NOT RANDOMNESS!  
 - DBBD

THE MISSISSIPPI RIVER  
 French-NIL  
 German-NUL  
 Latin-NULLUS

TIGRIS & EUPHRATES RIVERS  
 INDIUS & GANGES RIVERS  
 YANGTSE RIVER

PURPOSE OF ALL THIS IS TO PRODUCE LIGHTNING STORMS AND RAIN, HIGH PRESSURES ARE CONSTANTLY IN MOTION TOWARDS LOW PRESSURES, LIGHTNING STORMS ARE MORE FREQUENT @ THE EQUATOR BUT THOSE @ THE 30° DEGREE LATITUDES ARE MORE INTENSE.

LIKE THE RIVERS THE WIND CURRENTS ARE CONSTANTLY FLOWING BANDS OF ENERGY. @ 30° DEGREES NORTH, AIR CURRENTS MAKE A PHASE CHANGE, THEN AGAIN @ 60°, THEN AGAIN @ 90° DEGREES. NOW IT IS CLEAR THAT THE GREAT PYRAMID WAS PUT IN PLACE AS A GEODETIC MARKER WITH MANY PURPOSES.



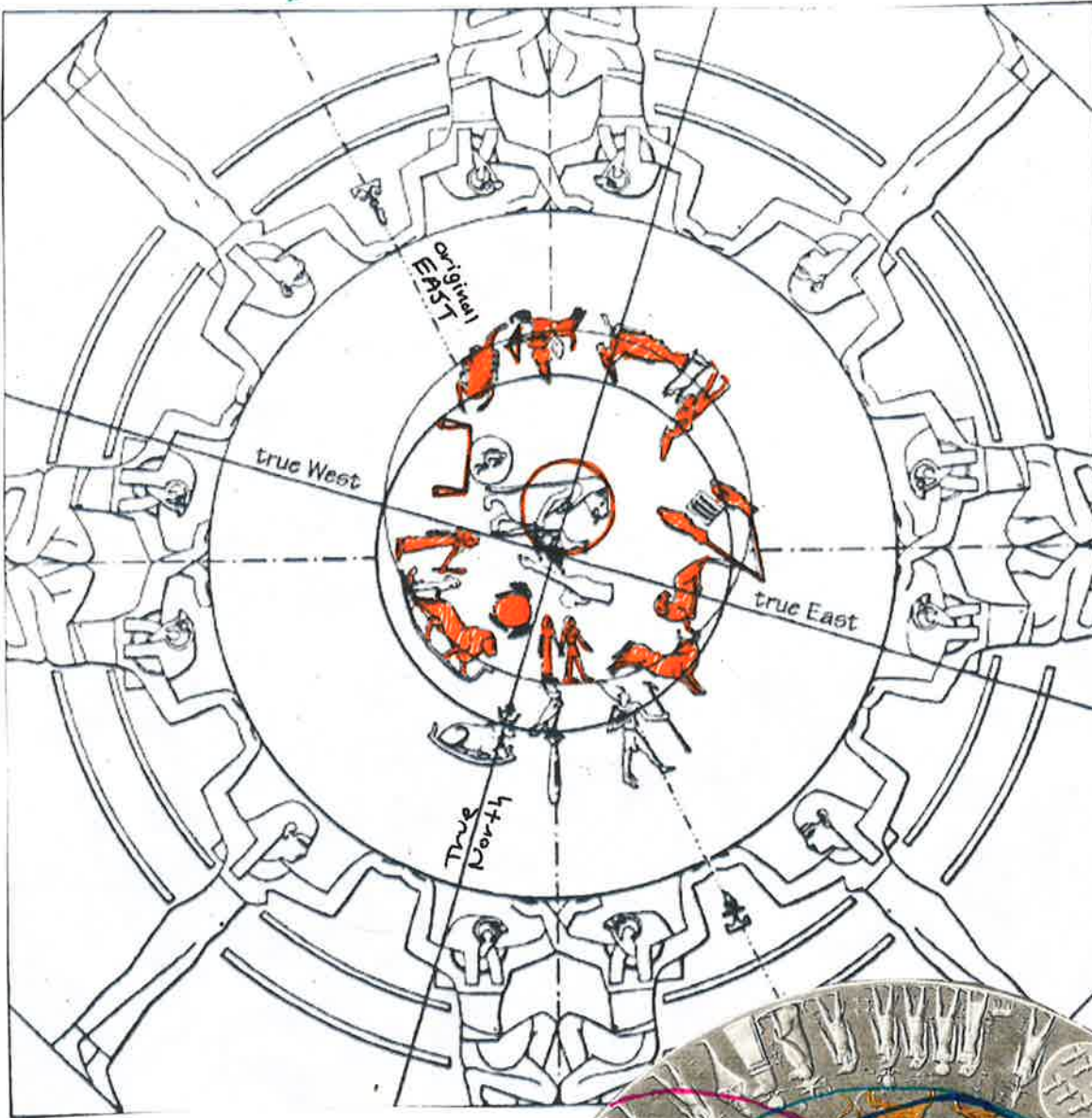

'THE ZODIAC STONE' @ HATHORS TEMPLE  
**DENDERAH, EGYPT**

BEFORE POLARIS "URSA MINOR" BECAME THE POLE STAR, (THUBAN) WAS THE POLE STAR, WHICH WAS A STAR IN THE CONSTELLATION DRACO. Known as the Hippo in Egypt.

— The MILKY WAY  
 — Capricorn  
 — Equator  
 — Cancer

The 3 Tropics  
 — THE DRIFT OF THE POLE STARS.  
 NOT DUE TO 'WOBBLE' OR 'TILT' OF THE EARTH. BUT DUE TO CYROMAGNETIC PRECESSION, THE PERPETUAL VORTEX @ THE CENTER OF EARTH. THE 'AXIS MUNDI'.

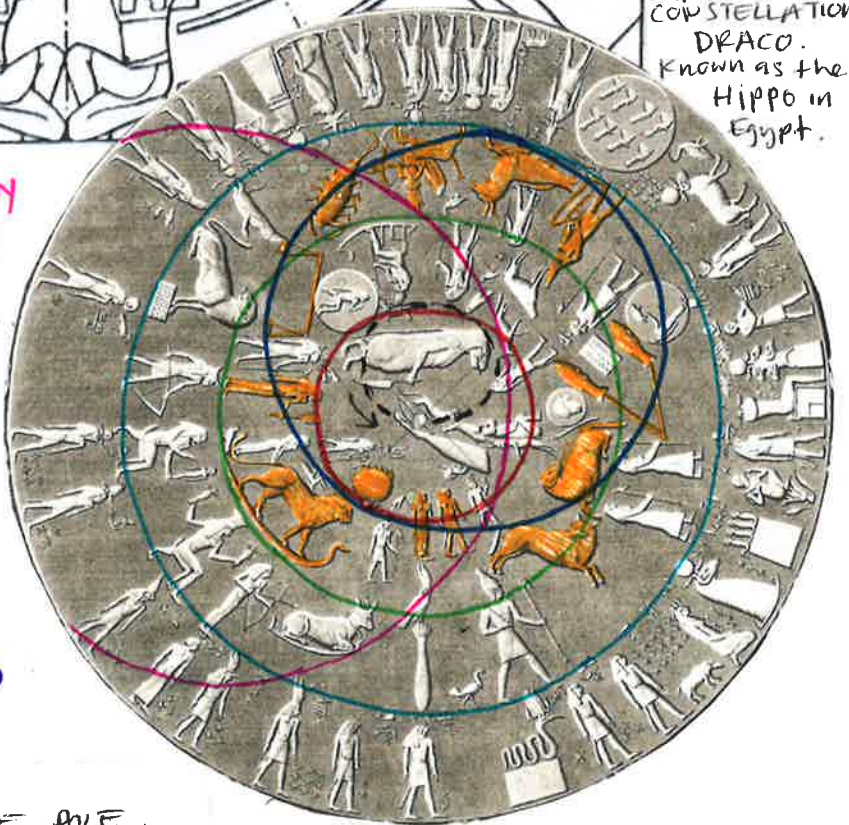

OUR ANCESTORS ONLY NEEDED ONE CELESTIAL-STARMAP, NOT '2'

THUBAN WILL RETURN AS THE POLE STAR ONCE AGAIN, TIME IS CYCLICAL! ∞



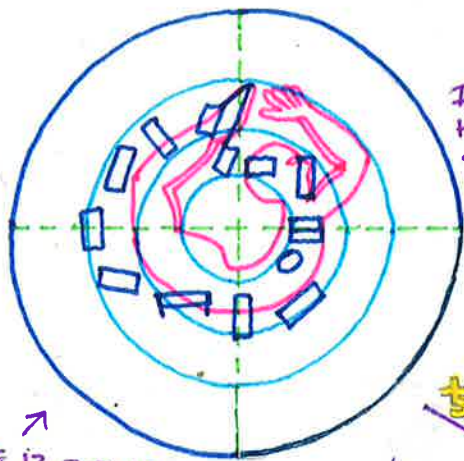

↑  
THE 12 ZODIACS  
ARE THE 12 TRIBES  
OF ISRAEL AKA 12  
SONS OF JACOB.

ISRAEL IS THE  
HEAL GRABBER

"OPHICUS" HOLDING  
"SERPENS" IS A DECAN  
OF SCORPIO ♏

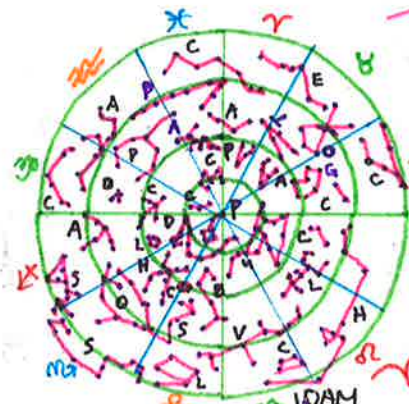
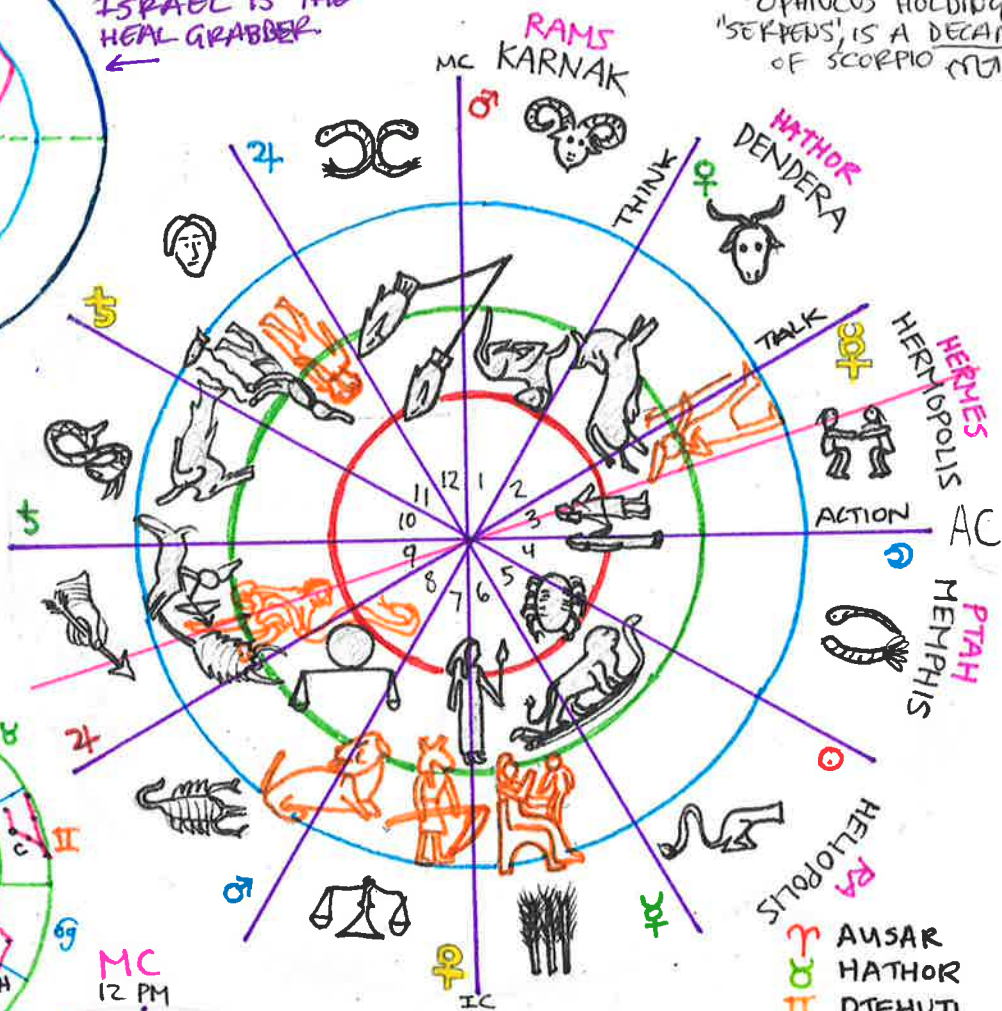

- AUSAR
- HATHOR
- DJEHUTI
- NEPHTHYS
- HERM
- GEB
- AUSET
- ANPU
- SEKHMET
- SET
- MAAT
- NUT

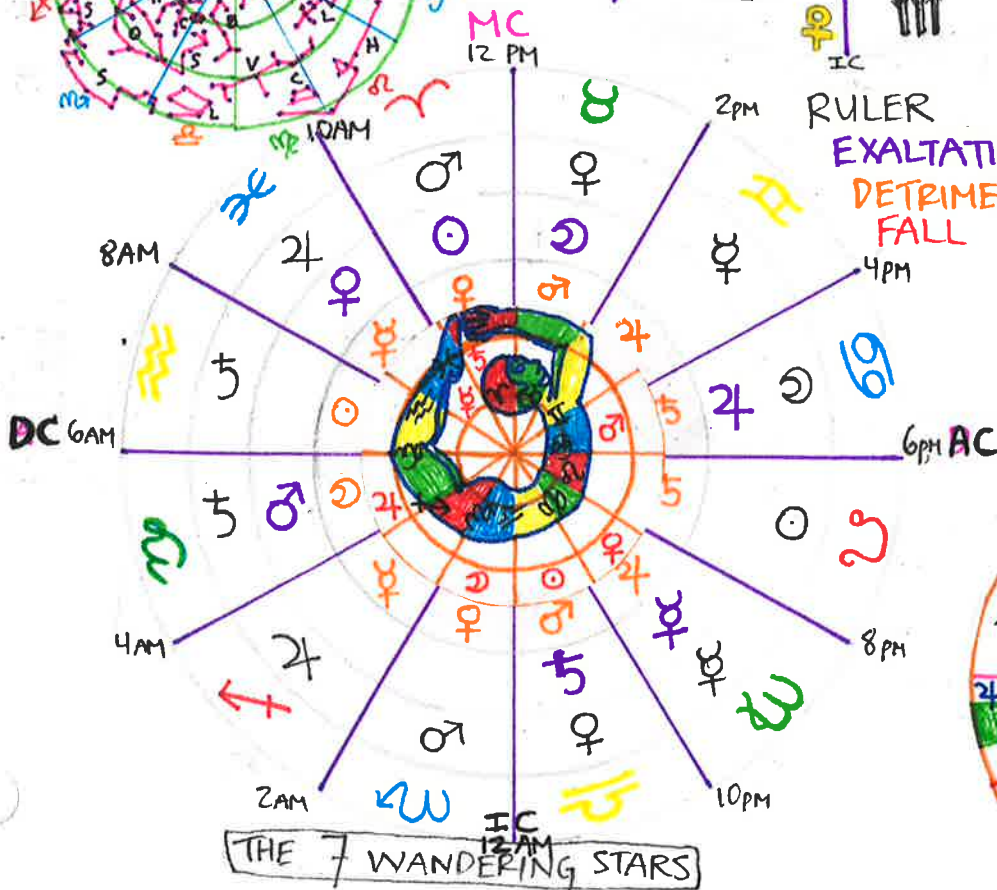

THE 7 WANDERING STARS





EVERY MONTH  
 WHEN THE MOON  
 TRANSITS YOUR SUN  
 SIGN, A PSYCHOPHYSICAL  
 GERM, OR A SEED IS BORN,  
 IN THE SOLAR PLEXUS.

VIRGO  
 ♍ BETH-LEHEM  
 "HOUSE OF BREAD"  
 AUGUST 21<sup>ST</sup>

AUTUMN  
 HARVEST  
 HALLOWEEN  FOR THE CROPS.

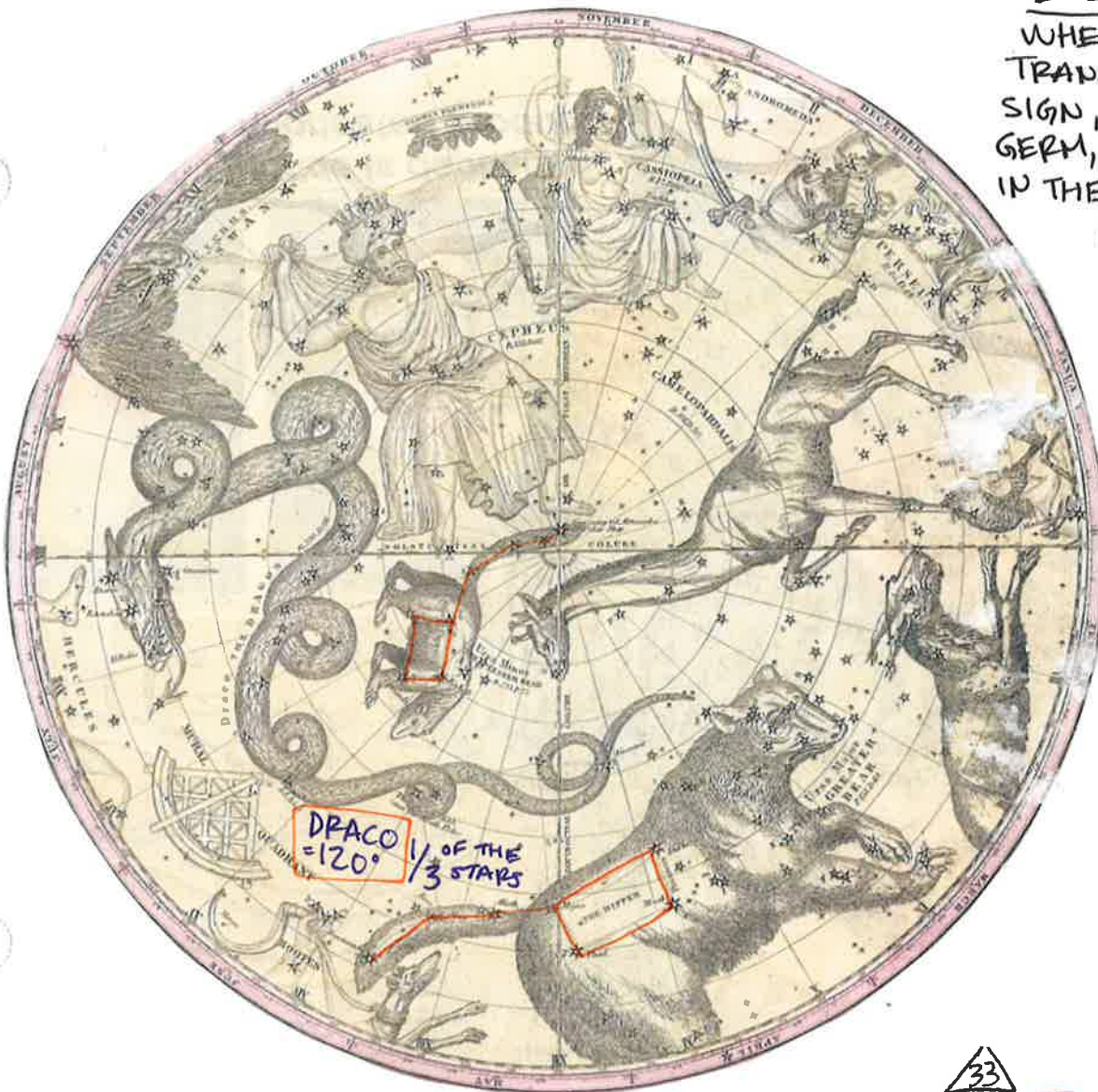

9 REALMS

YGGDRASIL

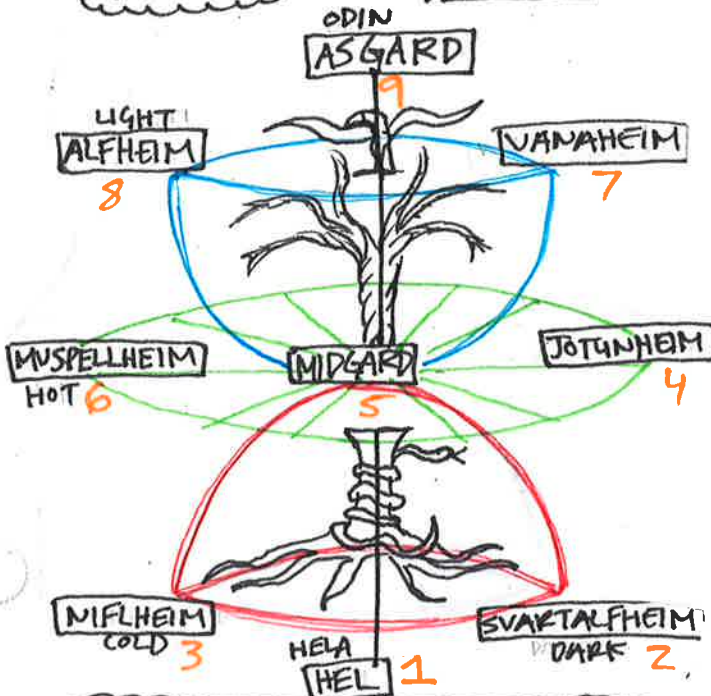

THE WORLD TREE / TREE OF LIFE

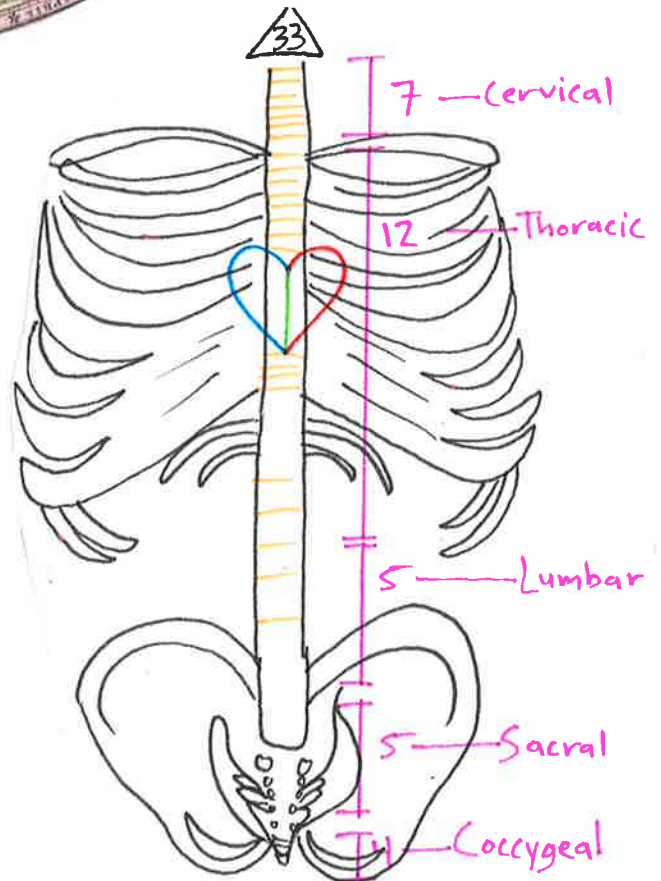



# THE ADAM KADMON IS YOU!

21 NORTH DECANS | 12 ZODIAC | 15 SOUTH DECANS

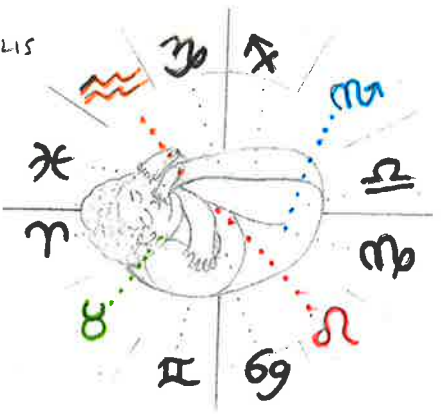
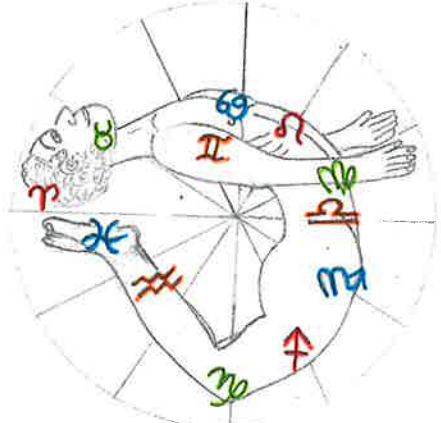
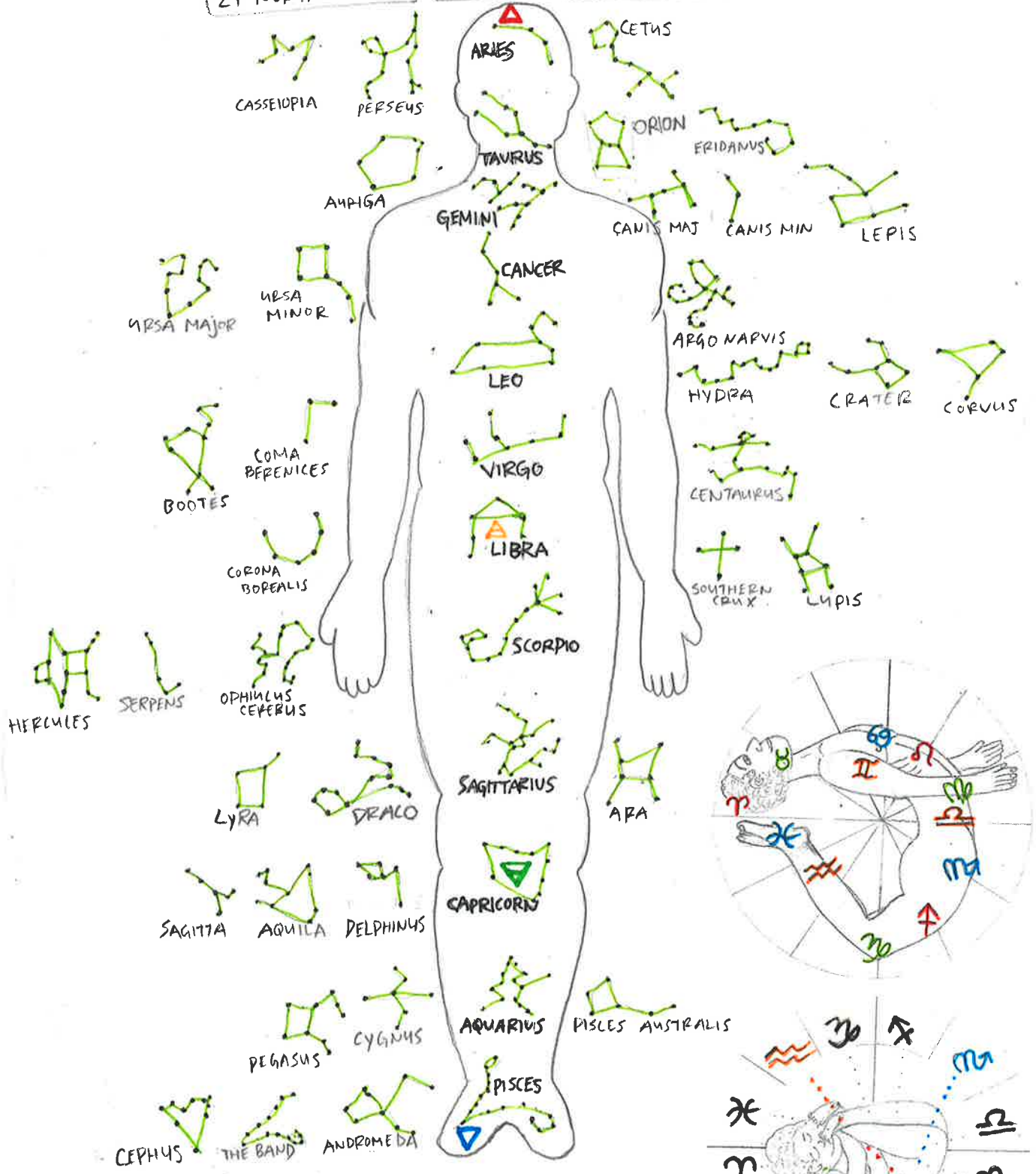



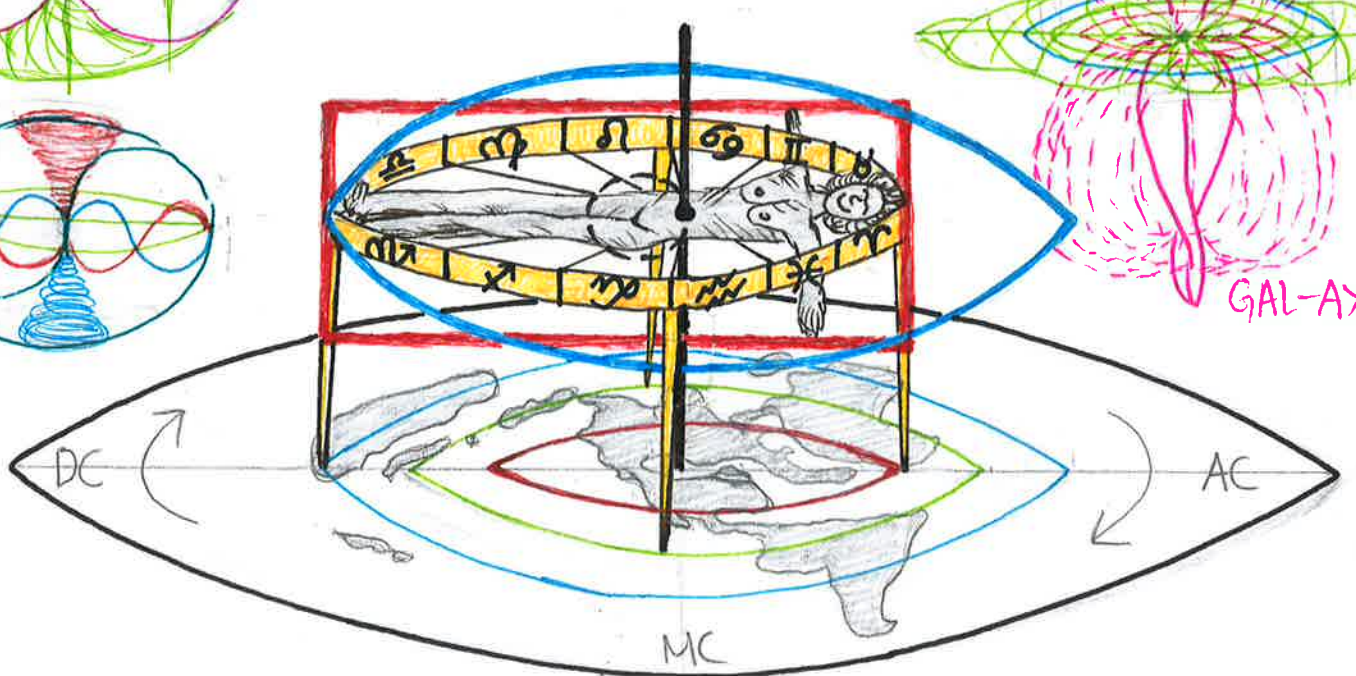
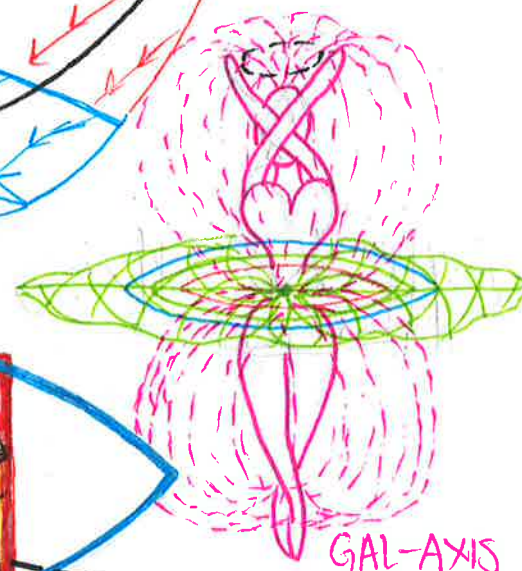
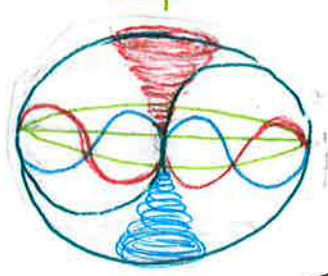
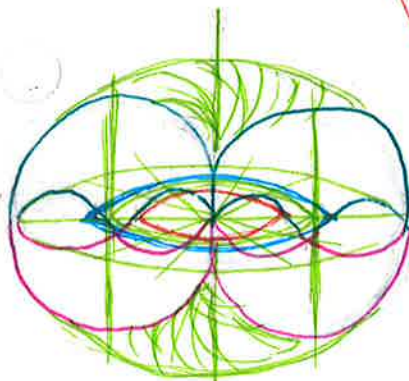
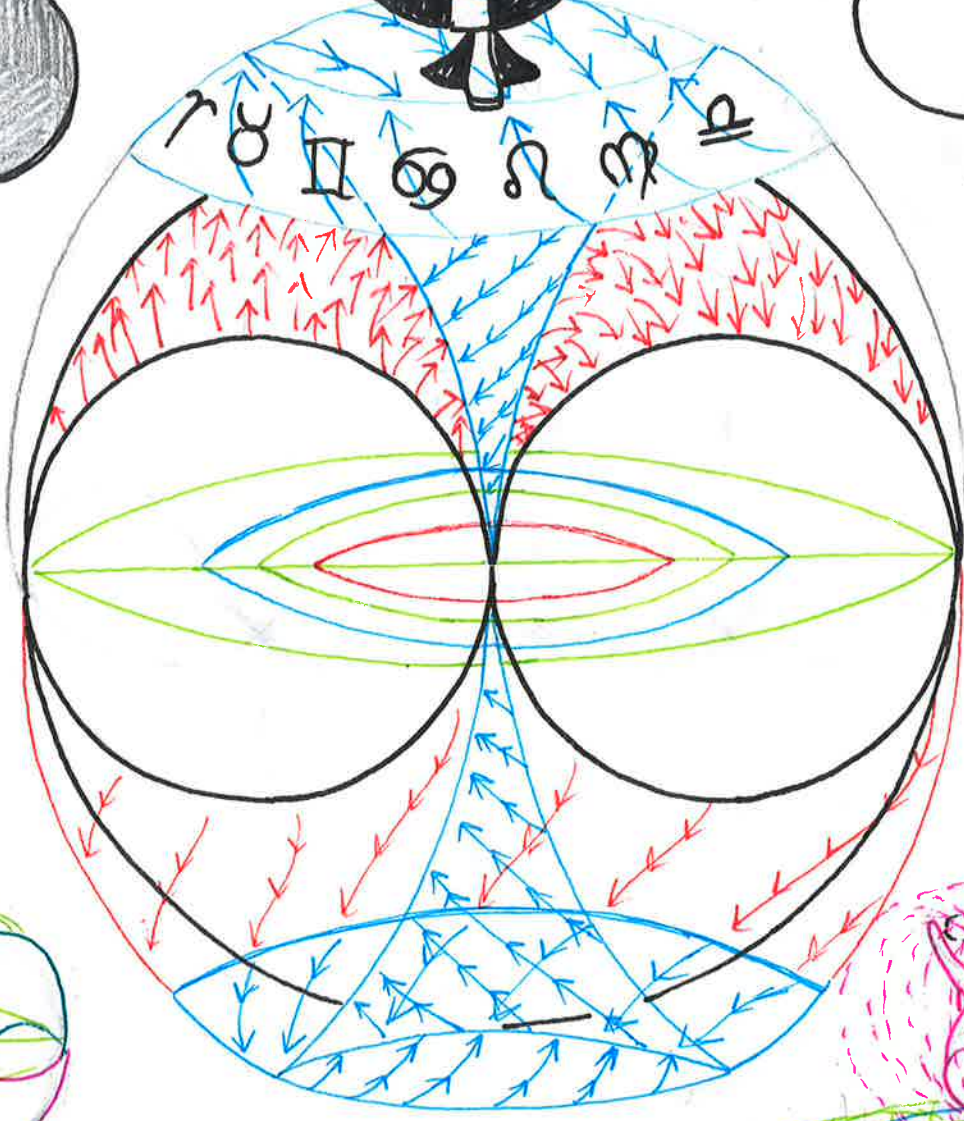



RECTIFICATION OF THE SQUARE  
 SQUARE PERIMETER = 4

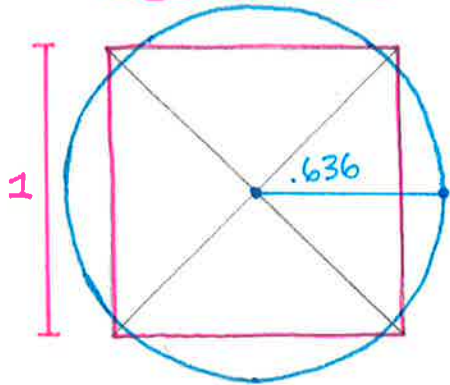

$C = 2\pi r$  or  $C = \pi d$

$.636 \times 2 = 1.272$

CIRCUMFERENCE =  $\pi \cdot \sqrt{\phi}$   
 3.9997968

SQUARING OF THE CIRCLE  
 SQUARE AREA = 1

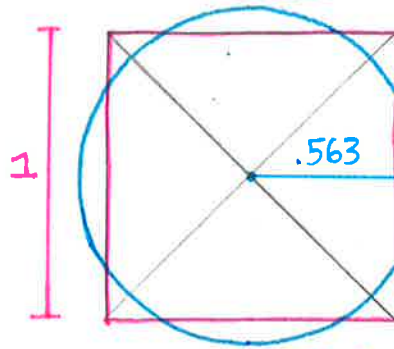

THE BODY IS TERRESTRIAL □

THE MIND IS EXTRA-TERRESTRIAL △

THE SOUL IS CELESTIAL ○

$C = \pi r^2$  or  $\pi r^2 = 1$

$r^2 = \frac{1}{\pi} \rightarrow r = \sqrt{\frac{1}{\pi}} \rightarrow (r = .563)$

CIRCUMFERENCE = 1

GIZA PYRAMIDO

KEPLERS TRIANGLE  
 "PHI RIGHT TRIANGLE"

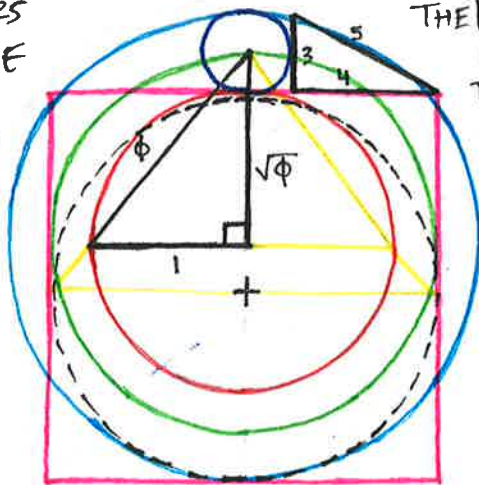

THE TROPICS ≠ THE ECLIPTIC

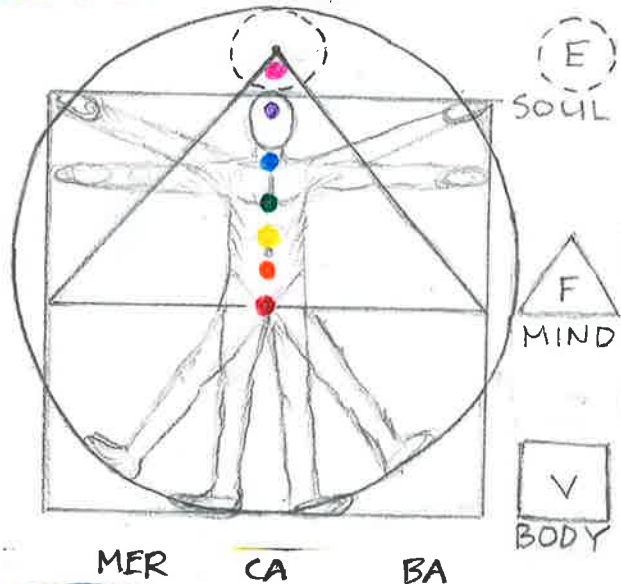

KEPLERS TRIANGLE

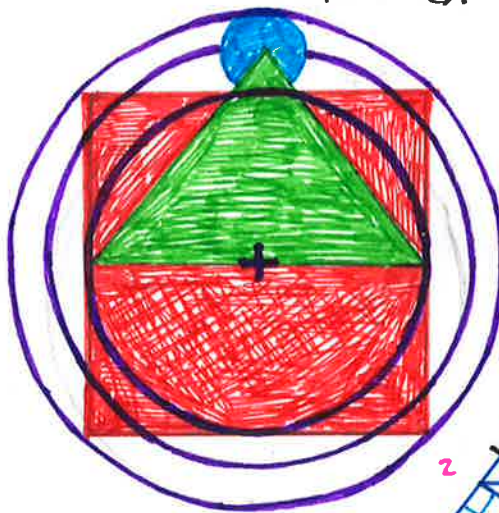
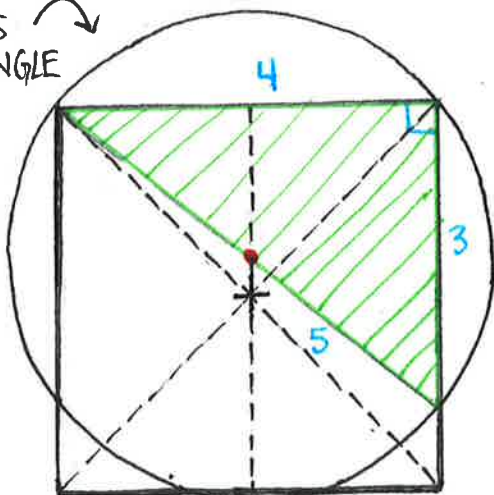

IN-PHI-NITE  
 ↑  
 FINITE

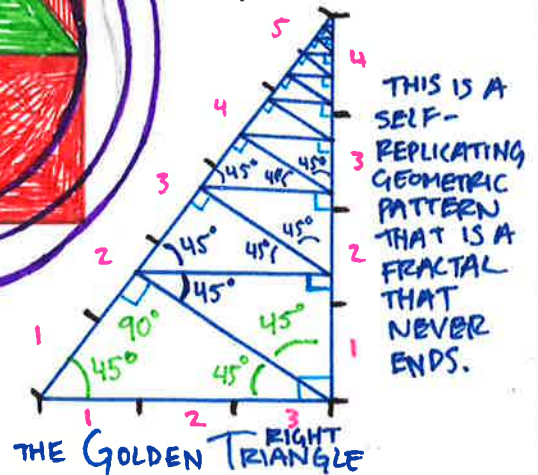

THIS IS A SELF-REPLICATING GEOMETRIC PATTERN THAT IS A FRACTAL THAT NEVER ENDS.



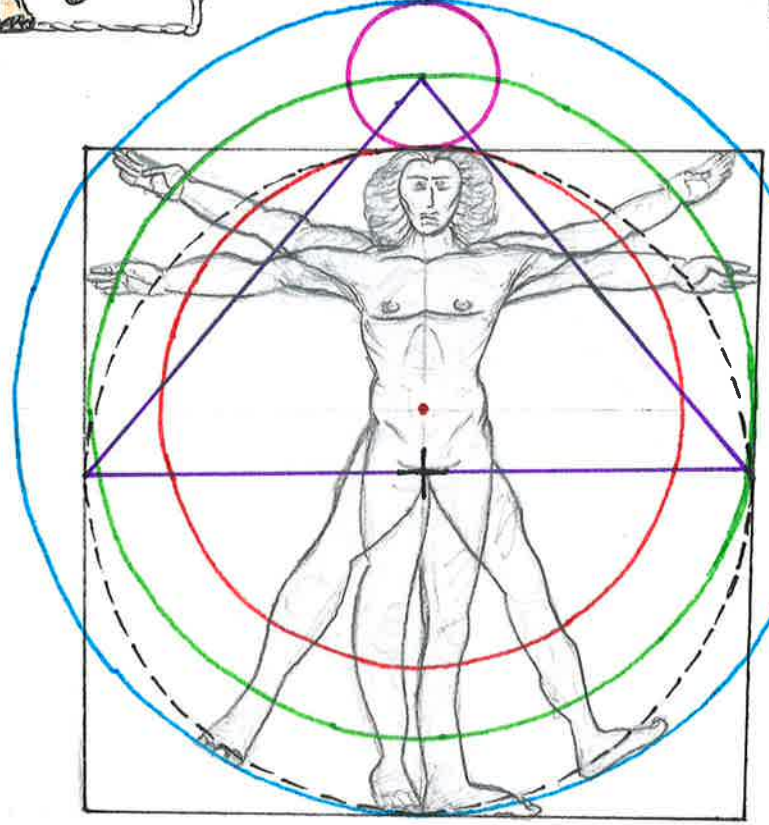
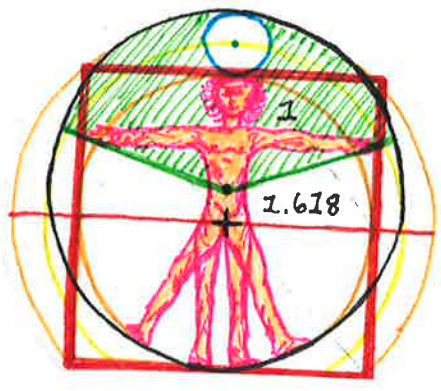
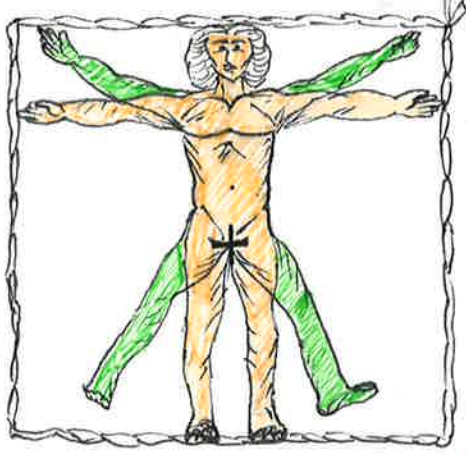

THE PYRAMID THAT IS CONSTRUCTED SHOWS THAT ITS HORIZONTAL BASE LIES @ THE MID-POINT OF THE SQUARE PASSING THROUGH THE GROIN CENTER, AND THE APEX PASSES THROUGH THE TOP OF THE SQUARE AND TOUCHES THE HEAVENLY CIRCLE.  
DIAMETER=1.2722

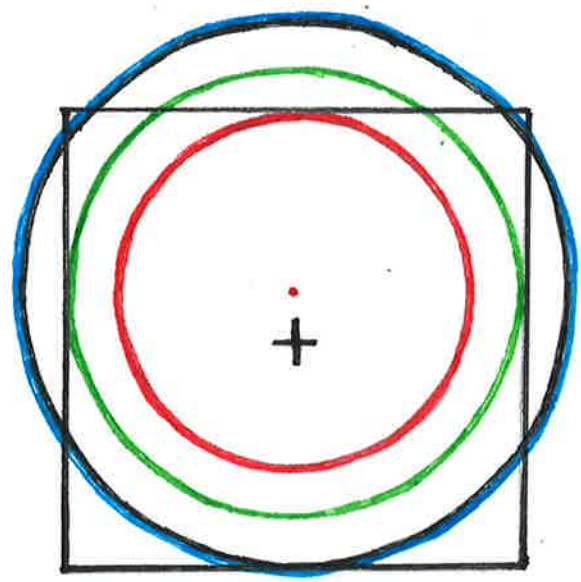
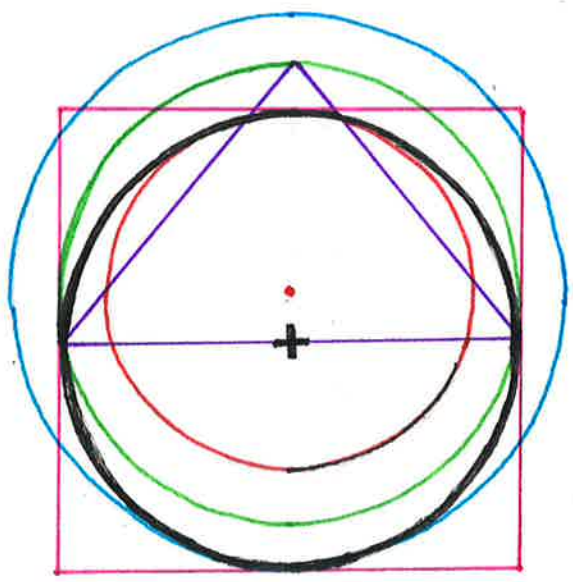

BRAHMAYAN = PATH TO THE ABSOLUTE. JACOBS LADDER TO HEAVEN THE PHILOSOPHERS STONE  
THE NATURAL REBIRTH TRANSCENDENTAL MEDITATION  
 ENLIGHTENMENT. KUNDALINI RISING JOURNEY TO THE SOUL THE ELIXIR OF LIFE  
RETURN TO THE DAO SPIRITUAL AWAKENING SHAMANIC TRANCE FOUNTAIN OF YOUTH!  
 THE KABBALISTIC CLIMB OF THE TREE OF LIFE.



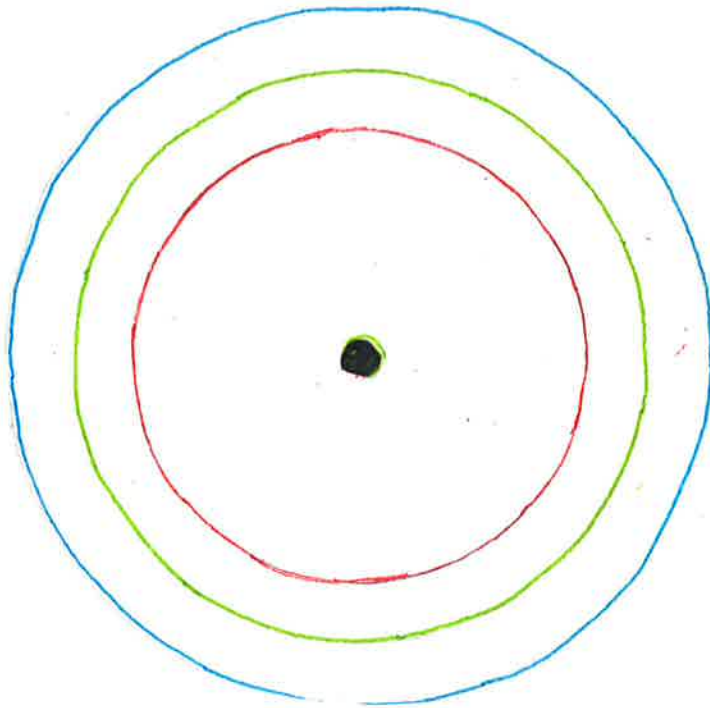
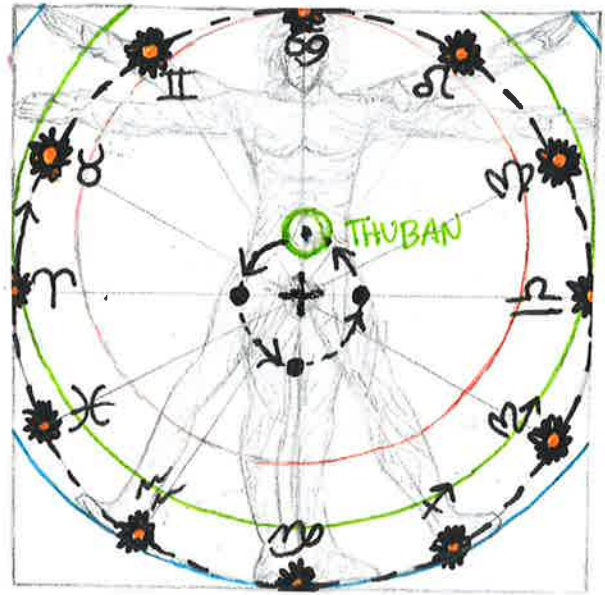
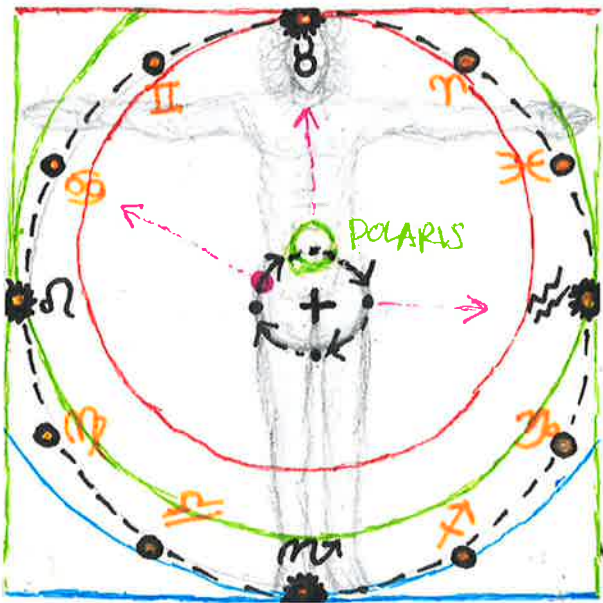

F	M	♈ 12 SAG
F	F	♌ 11 LEO
C	C	♍ 10 ARI
A	M	♎ 9 GEM
F	F	♏ 8 AQU
C	C	♐ 7 LIB
W	M	♑ 6 PIS
C	F	♒ 5 SCO
C	C	♓ 4 CAN
E	M	♈ 3 VIR
C	F	♉ 2 TAN
C	C	♊ 1 CAP

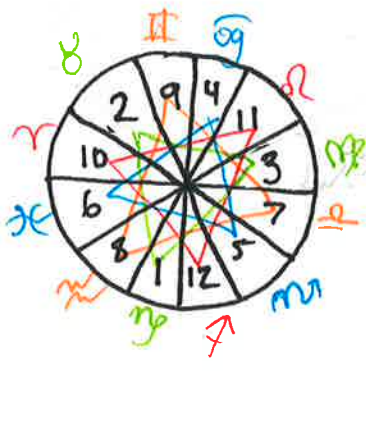

- ♈ Tin
- ♉ Gold
- ♊ Iron
- ♋ Mercury
- ♌ Lead
- ♍ Copper
- ♎ Tin
- ♏ Iron
- ♐ Silver
- ♑ Mercury
- ♒ Copper
- ♓ Lead

